

Ring cable lug - C-RCI 2,5/M5 - 3240024

Please be informed that the data shown in this PDF Document is generated from our Online Catalog. Please find the complete data in the user's documentation. Our General Terms of Use for Downloads are valid (<http://download.phoenixcontact.com>)



Ring cable lug, blue, 1.5-2.5 mm², M5

Product Features

- The sleeves are conically tapered to facilitate easy and correct insertion of the conductor
- The insulated ring cable lugs with plastic sleeve are hard-soldered and feature the 'EASY ENTRY' system

Key commercial data

package_quantity	100
GTIN	4046356452014

Technical data

Dimensions

Length (b)	23 mm
Width (a)	9.5 mm
Length of insulation sleeve (c)	11 mm
Inner dimension of the insulating collar (d)	4.5 mm
Distance between the center and the insulation sleeve (e)	7.3 mm
Inner diameter (f)	5.3 mm
Material thickness (g)	0.8 mm

Ambient conditions

Ambient temperature (operation)	-20 °C ... 105 °C
--	-------------------

General

Color	blue
Stripping length	8 mm
Components	Halogen-free
Inflammability class according to UL 94	V2
Material	Copper

classifications

eCl@ss

eCl@ss 4.0	27060701
eCl@ss 4.1	27060701

Ring cable lug - C-RCI 2,5/M5 - 3240024

classifications

eCl@ss

eCl@ss 5.0	27400201
eCl@ss 5.1	27400201
eCl@ss 6.0	27400201
eCl@ss 7.0	27400201
eCl@ss 8.0	27400201

ETIM

ETIM 2.0	EC000005
ETIM 3.0	EC000005
ETIM 4.0	EC001052
ETIM 5.0	EC001052

UNSPSC

UNSPSC 6.01	27113201
UNSPSC 7.0901	27121703
UNSPSC 11	27121703
UNSPSC 12.01	27121703
UNSPSC 13.2	27121703

Drawings

Ring cable lug - C-RCI 2,5/M5 - 3240024

Dimensioned drawing

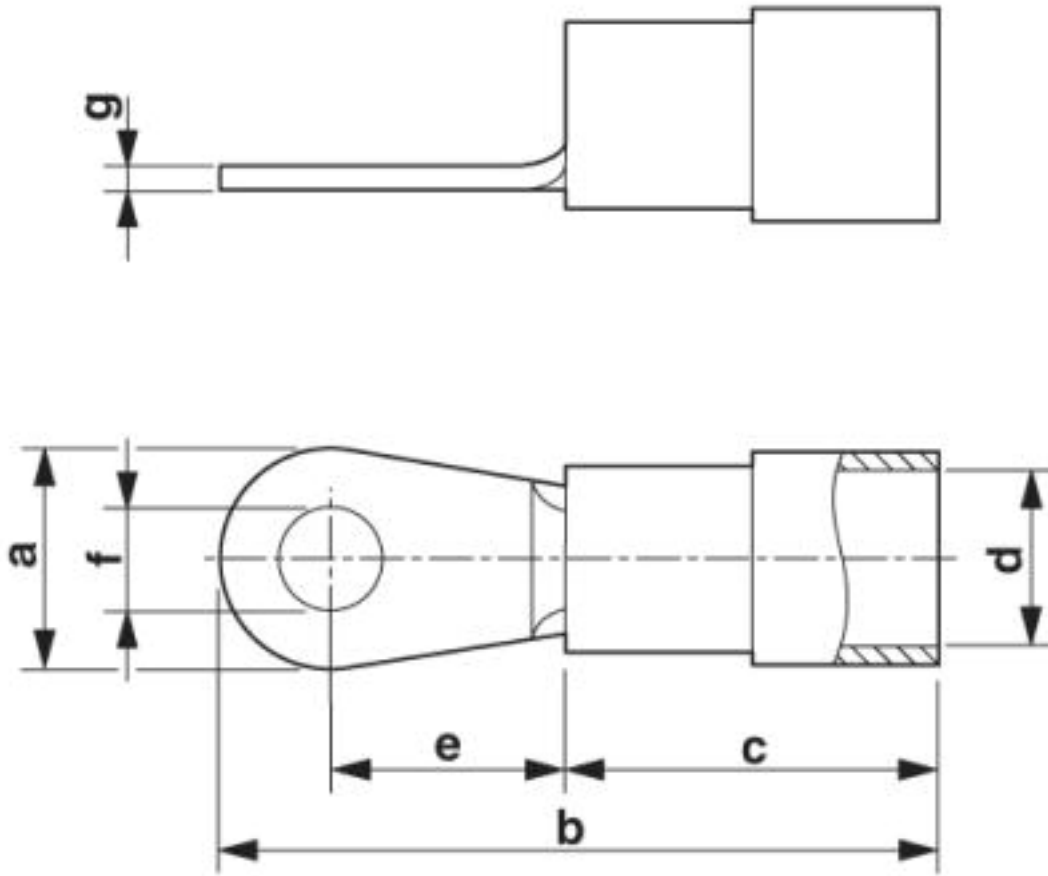

© Phoenix Contact 2013 - all rights reserved
<http://www.phoenixcontact.com>