

Sensor/actuator box - SACB-8/16-L- 5,0PUR SCO P - 1452725

Please be informed that the data shown in this PDF Document is generated from our Online Catalog. Please find the complete data in the user's documentation. Our General Terms of Use for Downloads are valid (<http://download.phoenixcontact.com>)



Sensor/actuator box, Connection method: M12-SPEEDCON-socket Plastic, Number of slots: 8, Number of positions: 5, Slot assignment: Double, Status indication: Yes, prnp; Master cable connection: Fixed connection 180°, PUR/PVC, Cable length: 5 m, Shielding: No

Product Features

- Safety in the field, thanks to molded housing and high degree of protection
- Flexible, distributed bundling of signals in one master cable
- Convenient: increased machine availability thanks to quick and easy diagnostics
- Save space: distributor box with double occupancy for two sensors in one slot
- Save time, thanks to installation with SPEEDCON rapid interlock system



Key commercial data

package_quantity	1
GTIN	4046356554008

Technical data

General

Rated voltage	24 V DC
Max. operating voltage U_{max}	30 V DC
Current carrying capacity per I/O signal	2 A
Current carrying capacity per slot	4 A
Total rated current	12 A
Number of positions	5
Number of slots	8
Sensor/actuator connection system	M12-SPEEDCON-socket

Ambient conditions

Degree of protection	IP65
Degree of protection	IP67
Ambient temperature (operation)	-25 °C ... 80 °C
Ambient temperature (operation)	-40 °C ... 90 °C (for fixed installation)
Ambient temperature (operation)	-5 °C ... 80 °C (for flexible installation)

Local diagnostics function

Local diagnostics	Supply voltage Green LED
-------------------	--------------------------

Sensor/actuator box - SACB-8/16-L- 5,0PUR SCO P - 1452725

Technical data

Local diagnostics function

Local diagnostics	Status display I/O Yellow LED
-------------------	-------------------------------

Master cable connection data

Connection method	Fixed connection
Length of cable	5 m
Tightening torque slot sensor/actuator cable	0.4 Nm
Tightening torque screw plug	0.4 Nm

Insulation material

Housing material	PBT
Material of the moulding mass	PUR
Contact material	Cu alloy
Contact surface material	Gold-plated
Contact carrier material	PA
Material of threaded sleeve	PBT
Material, O-ring	NBR

Pin assignment

Slot/position = Wire color or connection	1 / 4 (A) = WH
Slot/position = Wire color or connection	1 / 2 (B) = GY/PK
Slot/position = Wire color or connection	2 / 4 (A) = GN
Slot/position = Wire color or connection	2 / 2 (B) = RD/BU
Slot/position = Wire color or connection	3 / 4 (A) = YE
Slot/position = Wire color or connection	3 / 2 (B) = WH/GN
Slot/position = Wire color or connection	4 / 4 (A) = GY
Slot/position = Wire color or connection	4 / 2 (B) = BN/GN
Slot/position = Wire color or connection	5 / 4 (A) = PK
Slot/position = Wire color or connection	5 / 2 (B) = WH/YE
Slot/position = Wire color or connection	6 / 4 (A) = RD
Slot/position = Wire color or connection	6 / 2 (B) = YE/BN
Slot/position = Wire color or connection	7 / 4 (A) = BK
Slot/position = Wire color or connection	7 / 2 (B) = WH/GY
Slot/position = Wire color or connection	8 / 4 (A) = VT
Slot/position = Wire color or connection	8 / 2 (B) = GY/BN
Slot/position = Wire color or connection	1-4 / 1 (+ 24 V) = BN
Slot/position = Wire color or connection	1-8 / 3 (0 V) = BU
Slot/position = Wire color or connection	1-8 / 5 (PE) = GN/YE

Cable

Cable type	PUR/PVC black
Cable type (abbreviation)	PUR
Cable abbreviation	LiYY11Y-HF
UL AWM style	20549 (80°C/300 V)
Conductor cross section	16x 0.5 mm ² (signal line)

Sensor/actuator box - SACB-8/16-L- 5,0PUR SCO P - 1452725

Technical data

Cable

Conductor cross section	3x 1 mm ² (power line)
AWG signal line	20
AWG power supply	17
Conductor structure signal line	28x 0.15 mm
Conductor structure, voltage supply	56x 0.15 mm
Core diameter including insulation	1.5 mm ±0.1 mm (signal line)
Core diameter including insulation	2.1 mm ±0.1 mm (power line)
Wire colors	Brown, blue, green-yellow, white, green, yellow, gray, pink, red, black, violet, gray-pink, red-blue, white-green, brown-green, white-yellow, yellow-brown, white-gray, gray-brown
Overall twist	Wires twisted in layers
External sheath, color	Black RAL 9005
Inner sheath thickness	≥ 0.15 mm
Outer sheath thickness	≥ 0.76 mm
External cable diameter D	10.5 mm ± 0.2 mm
Minimum bending radius, fixed installation	7.5 x D
Minimum bending radius, flexible installation	10 x D
Number of bending cycles	1500000
Minimum bending radius, drag chain applications	10 x D
Traversing path	2 m
Traversing rate	2 m/s
Cable weight	183.7 kg/km
Outer sheath, material	PUR
Material, inner sheath	PVC
Material conductor insulation	PVC
Conductor material	Bare Cu litz wires
Nominal voltage, cable	300 V
Test voltage, cable	2000 V
Special properties	Silicone-free
Flame resistance	According to DIN EN 50265
Resistance to oil	As per VDE 0472 Part 803
Other resistance	Highly resistant to acids, alkaline solutions and solvents
Ambient temperature (operation)	-40 °C ... 90 °C (cable, fixed installation)
Ambient temperature (operation)	-5 °C ... 80 °C (cable, flexible installation)

classifications

eCl@ss

eCl@ss 4.0	27140815
eCl@ss 4.1	27140815
eCl@ss 5.0	27143423
eCl@ss 5.1	27143423

Sensor/actuator box - SACB-8/16-L- 5,0PUR SCO P - 1452725

classifications

eCl@ss

eCl@ss 6.0	27279219
eCl@ss 7.0	27279219
eCl@ss 8.0	27279219

ETIM

ETIM 4.0	EC002585
ETIM 5.0	EC002585

UNSPSC

UNSPSC 6.01	31261501
UNSPSC 7.0901	31261501
UNSPSC 11	31261501
UNSPSC 12.01	31261501
UNSPSC 13.2	31261501

approvals

UL Recognized / cUL Recognized / GOST / cULus Recognized /

Approval details

UL Recognized 	
Nominal voltage UN	24 V
Nominal current IN	
mm ² /AWG/kcmil	

cUL Recognized 	
Nominal voltage UN	24 V
Nominal current IN	
mm ² /AWG/kcmil	

GOST 	
---	--

Sensor/actuator box - SACB-8/16-L- 5,0PUR SCO P - 1452725

approvals

cULus Recognized  US

accessories

Protective cap

PROT-MS SCO - 1553129



Device marking

SS-ZB 17,5 WH - 0804963



SS-ZB 17,5 YE - 0804976



Labeled device marker

SS-ZB 17,5 WH CUS - 0824468



Sensor/actuator box - SACB-8/16-L- 5,0PUR SCO P - 1452725

accessories

SS-ZB 17,5 YE CUS - 0824469



Torque tool

TSD 04 SAC - 1208429



Screwdriver tools

SAC BIT M12-D15 - 1208432



SACC BIT M12-D20 - 1208445



Drawings

Sensor/actuator box - SACB-8/16-L- 5,0PUR SCO P - 1452725

Dimensioned drawing

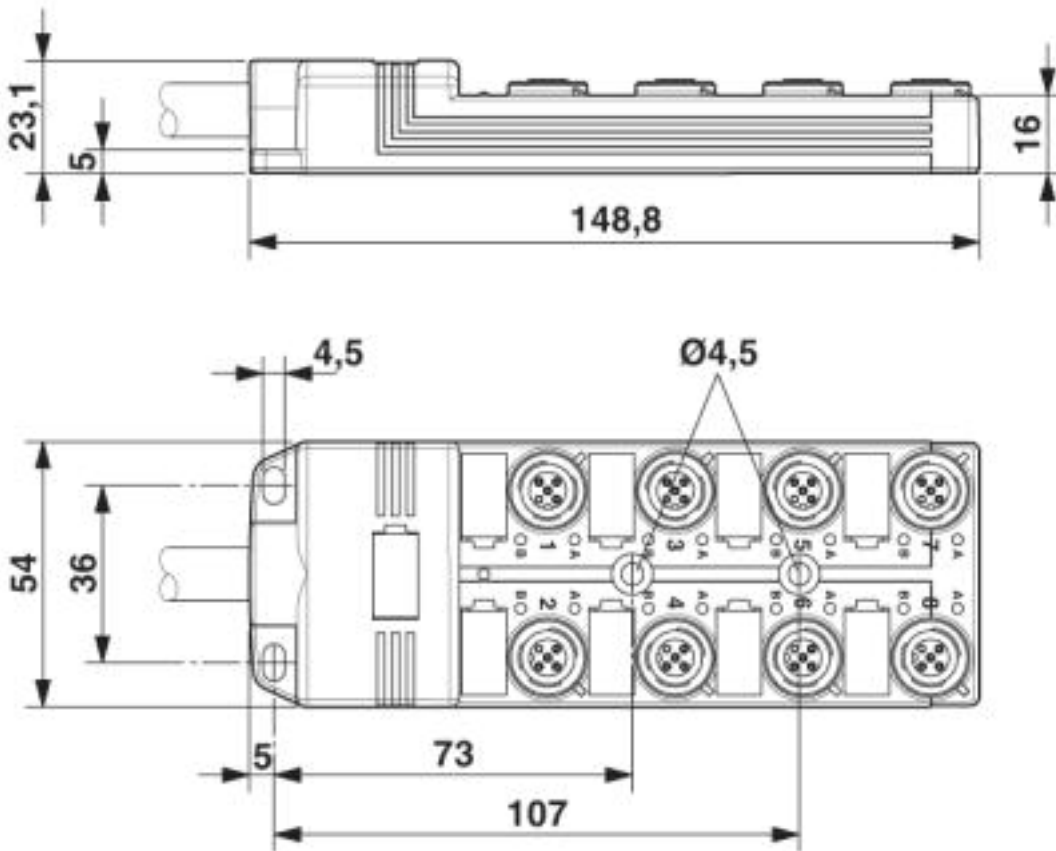

Circuit diagram

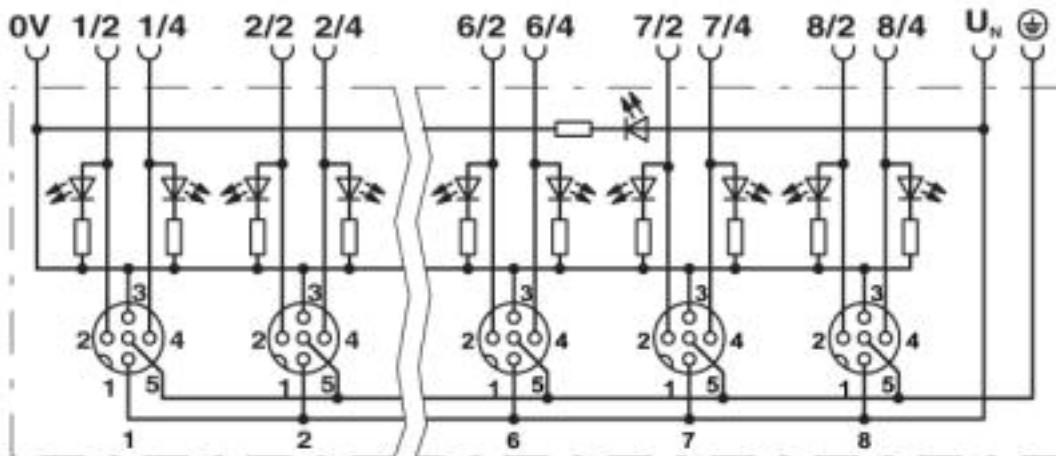

Sensor/actuator box - SACB-8/16-L- 5,0PUR SCO P - 1452725

Schematic diagram

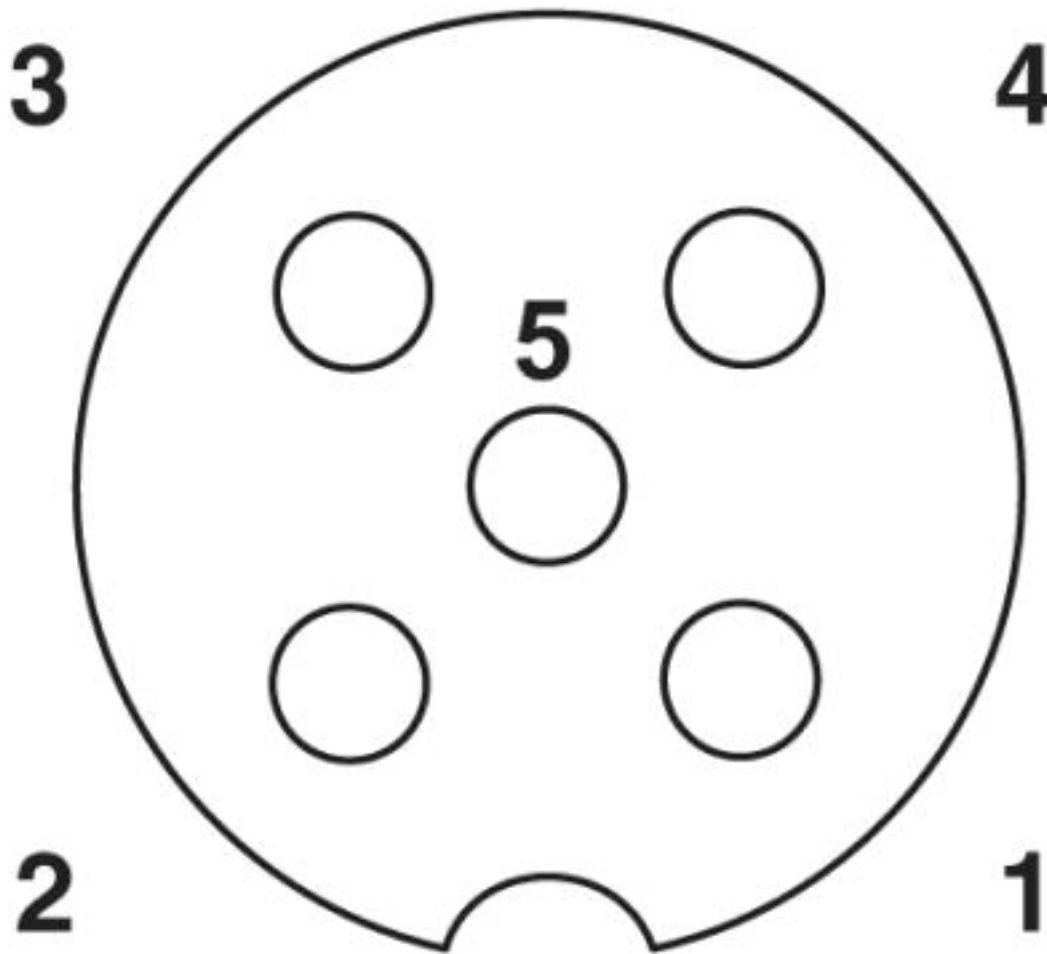

M12 slot, socket, 5-pos.

Sensor/actuator box - SACB-8/16-L- 5,0PUR SCO P - 1452725

Cable cross section

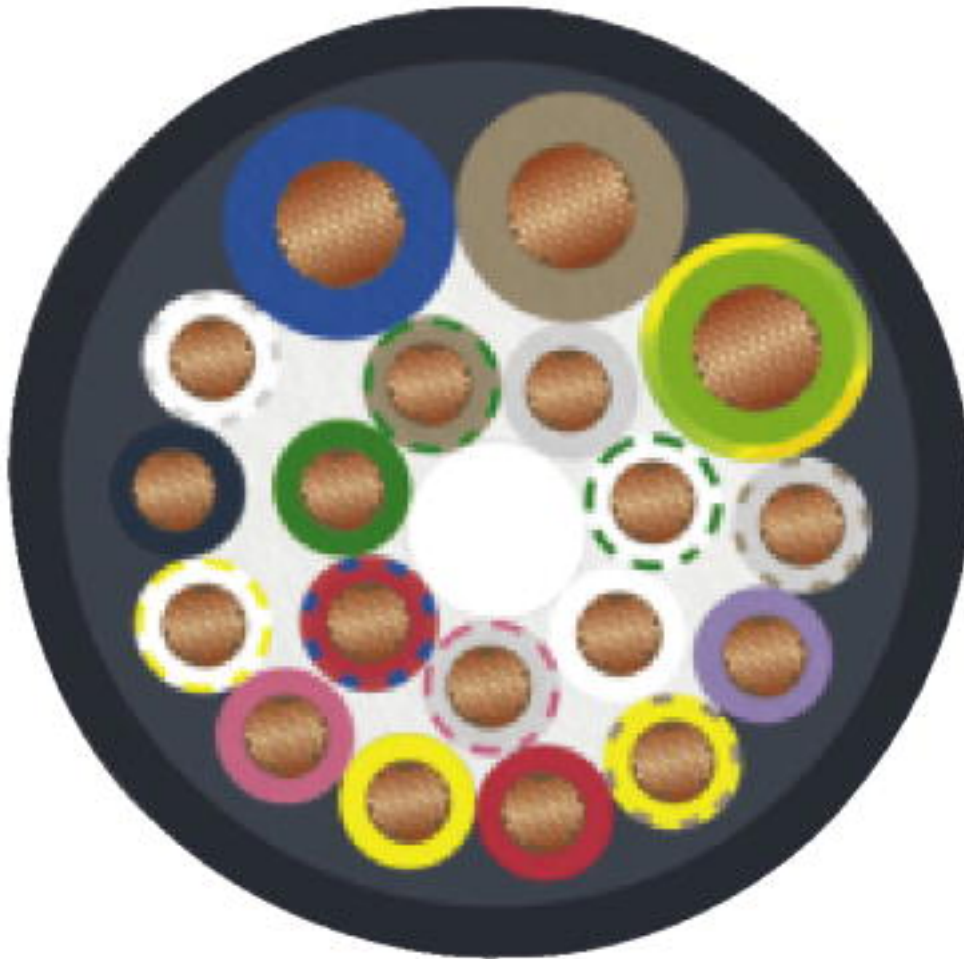

PUR/PVC black [PUR]

© Phoenix Contact 2013 - all rights reserved
<http://www.phoenixcontact.com>