

Sensor/Actuator cable - SAC-5P- 5,0-PUR/AD-2L - 1435108

Please be informed that the data shown in this PDF Document is generated from our Online Catalog. Please find the complete data in the user's documentation. Our General Terms of Use for Downloads are valid (<http://download.phoenixcontact.com>)



Sensor/Actuator cable, 5-position, PUR halogen-free, Black RAL 9005, Free cable end, on Valve connector AD (pressure switch), with 2 LEDs, Cable length: 5 m

Product Features

- Easy and safe: 100% electrically tested plug-in components
- Robust valve connector without protective circuit
- Our standard: robust halogen-free PUR cable

Key commercial data

package_quantity	1
GTIN	4046356413466

Technical data

Dimensions

Length of cable	5 m
Stripping length of the free conductor end	50 mm

Ambient conditions

Ambient temperature (operation)	-20 °C ... 85 °C (valve plug)
Degree of protection	IP65
Degree of protection	IP67

General

Rated current at 40°C	4 A
Rated voltage	24 V
Number of positions	5
Contact resistance	≤ 5 mΩ
Insulation resistance	≥ 100 MΩ
Status display	2 LEDs
Protective circuit/component	Unwired
Surge voltage category	III
Pollution degree	3
Torque	0.6 Nm (valve plug)

Material

Inflammability class according to UL 94	V0
--	----

Sensor/Actuator cable - SAC-5P- 5,0-PUR/AD-2L - 1435108

Technical data

Material

Valve plug contact material	CuSn
Valve plug contact surface material	Sn
Valve plug contact insert material	PA 6
Material housing valve plug	TPU
Sealing material	TPU (Seal molded)

Cable

Cable type	PUR halogen-free black
Cable type (abbreviation)	PUR
Cable abbreviation	Li9Y11Y-HF
UL AWM style	20549
Conductor cross section	5x 0.5 mm ²
AWG signal line	20
Conductor structure signal line	28x 0.15 mm
Core diameter including insulation	1.5 mm ±0.05 mm (signal line)
Wire colors	Black 1, black 2, black 3, black 4, green/yellow
Overall twist	5 cores, twisted
External sheath, color	Black-gray RAL 7021
External cable diameter D	5.3 mm ±0.02 mm
Smallest bending radius, fixed installation	26.5 mm
Smallest bending radius, movable installation	53 mm
Number of bending cycles	15000000
Bending radius	50 mm
Traversing path	0.9 m
Traversing rate	5 m/s
Acceleration	30 m/s ²
Outer sheath, material	PUR
Material conductor insulation	PP
Conductor material	Bare Cu litz wires
Insulation resistance	min. 20 MΩ*km
Conductor resistance	39 Ω/km (at 20 °C)
Nominal voltage, cable	300 V
Test voltage, cable	1200 V
Special properties	Flexible cable conduit capable
Special properties	Silicone-free
Special properties	Free of substances which would hinder coating with paint or varnish
Flame resistance	in accordance with DIN UL-Style 20549
Halogen-free	in accordance with DIN VDE 0472 part 815
Resistance to oil	in accordance with DIN EN 60811-2-1
Other resistance	Highly resistant to acids, alkaline solutions and solvents
Other resistance	hydrolysis and microbe resistant

Sensor/Actuator cable - SAC-5P- 5,0-PUR/AD-2L - 1435108

Technical data

Cable

Other resistance	Largely oil-resistant
Other resistance	partly UV-resistant in accordance with DIN EN ISO 4892-2-A
Ambient temperature (operation)	-40 °C ... 80 °C (cable, fixed installation)
Ambient temperature (operation)	-20 °C ... 80 °C (cable, flexible installation)

classifications

eCl@ss

eCl@ss 4.0	27060306
eCl@ss 4.1	27060306
eCl@ss 5.0	27061801
eCl@ss 5.1	27061801
eCl@ss 6.0	27061801
eCl@ss 7.0	27061801
eCl@ss 8.0	27061801

ETIM

ETIM 3.0	EC001855
ETIM 4.0	EC001855
ETIM 5.0	EC001855

UNSPSC

UNSPSC 6.01	31251501
UNSPSC 7.0901	31251501
UNSPSC 11	31251501
UNSPSC 12.01	31251501
UNSPSC 13.2	31251501

approvals

GOST /

Approval details



accessories

Mounting material

Sensor/Actuator cable - SAC-5P- 5,0-PUR/AD-2L - 1435108

accessories

SAC-V-SCREW-M3-29 KNURL - 1403779



Torque tool

TSD-M 1,2NM - 1212224



Screwdriver tools

SF-BIT-PH 1-70 - 1212582



Conductor marking

PABA WH/15 - 1013151



PABA YE/15 - 1013698



Sensor/Actuator cable - SAC-5P- 5,0-PUR/AD-2L - 1435108

accessories

PABA RD/15 - 1013944



Marker carrier cable

PATG 2/15 - 1013038



PATG 3/15 - 1013041



PATG 4/15 - 1013054



Marker pen

B-STIFT - 1051993



Cutting tools

Sensor/Actuator cable - SAC-5P- 5,0-PUR/AD-2L - 1435108

accessories

CUTFOX-S VDE - 1212207



Stripping tool

WIREFOX SAC - 1212623



WIREFOX 10 - 1212150



accessories

WIREFOX SAC-1 - 1212757

Drawings

Sensor/Actuator cable - SAC-5P- 5,0-PUR/AD-2L - 1435108

Dimensioned drawing

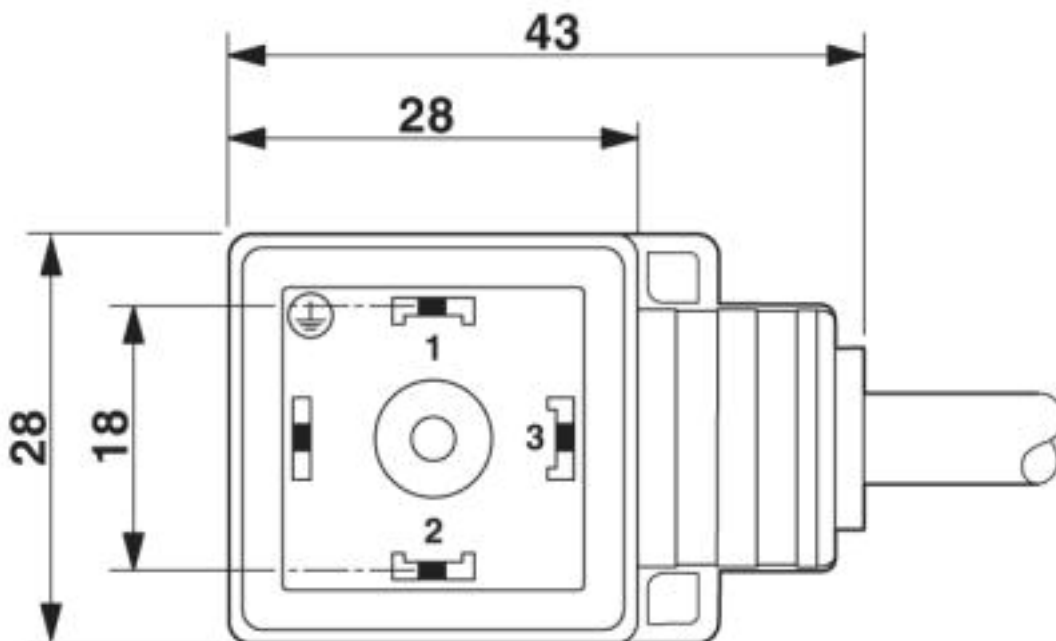

Valve connector, type AD

Dimensioned drawing

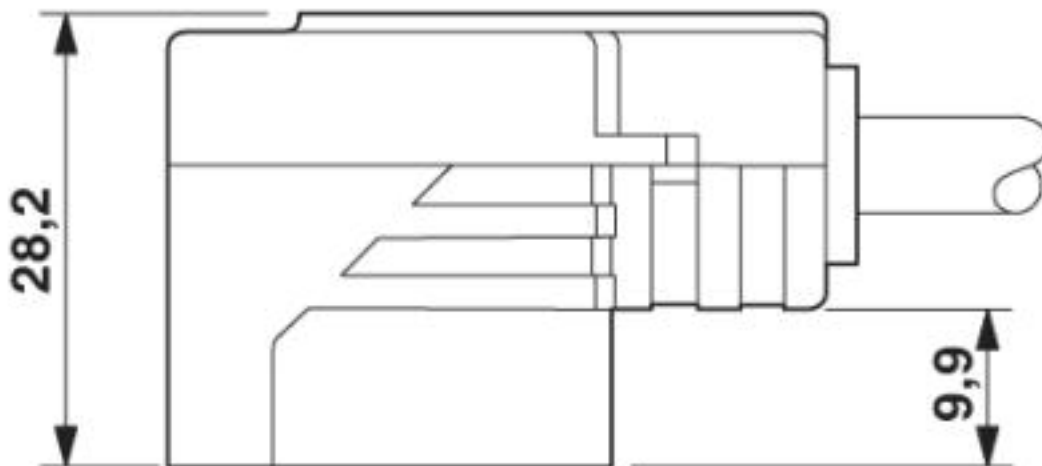

Valve connector, type AD, side view

Sensor/Actuator cable - SAC-5P- 5,0-PUR/AD-2L - 1435108

Circuit diagram

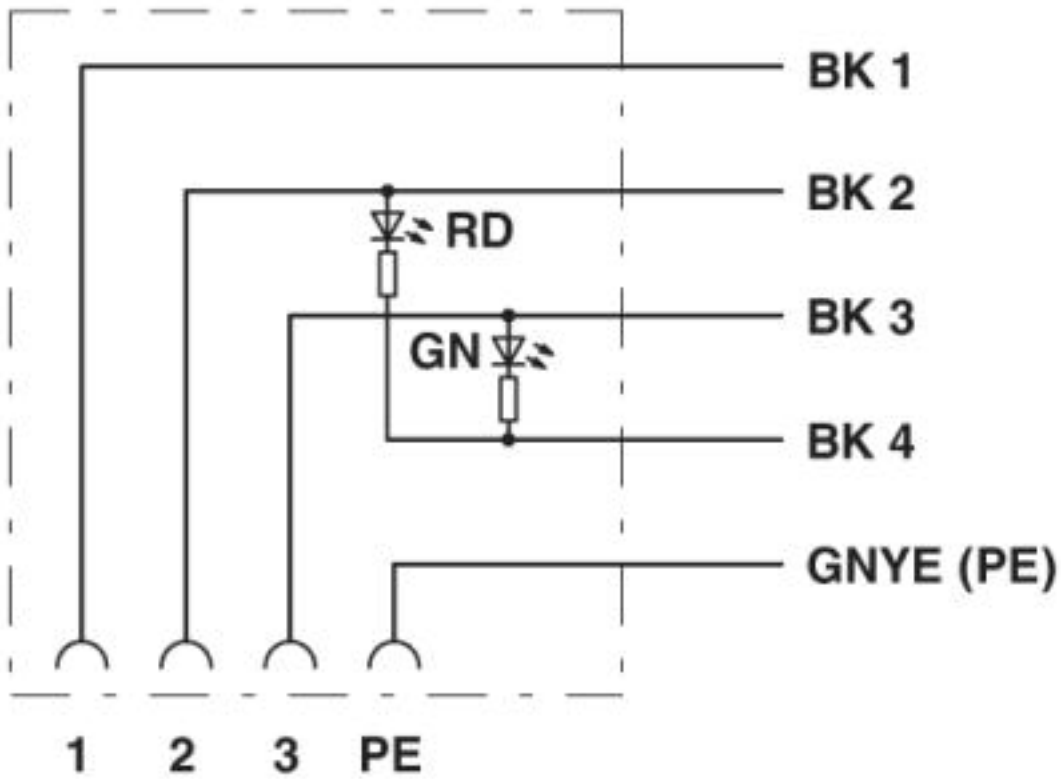

Contact assignment of the valve plug

Sensor/Actuator cable - SAC-5P- 5,0-PUR/AD-2L - 1435108

Schematic diagram

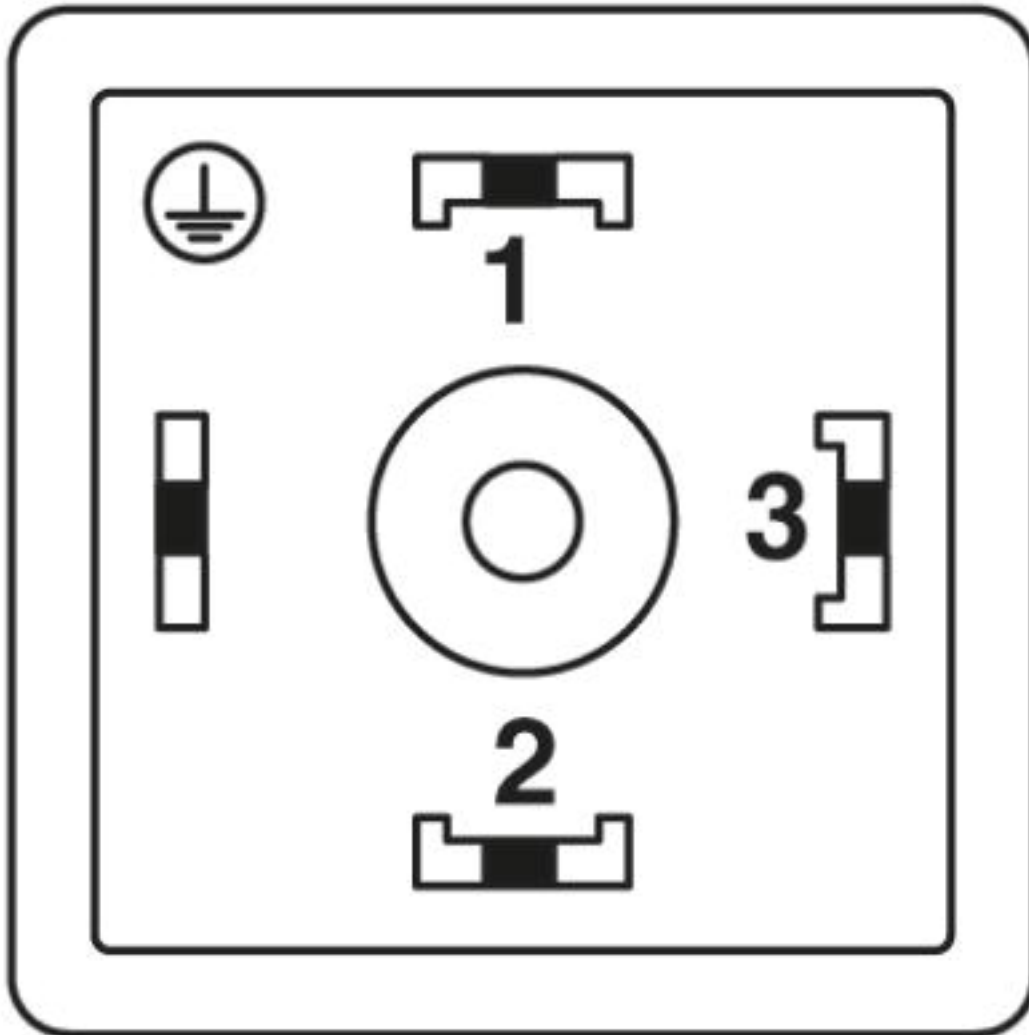

Valve plug connector pin assignment, type AD

Sensor/Actuator cable - SAC-5P- 5,0-PUR/AD-2L - 1435108

Cable cross section

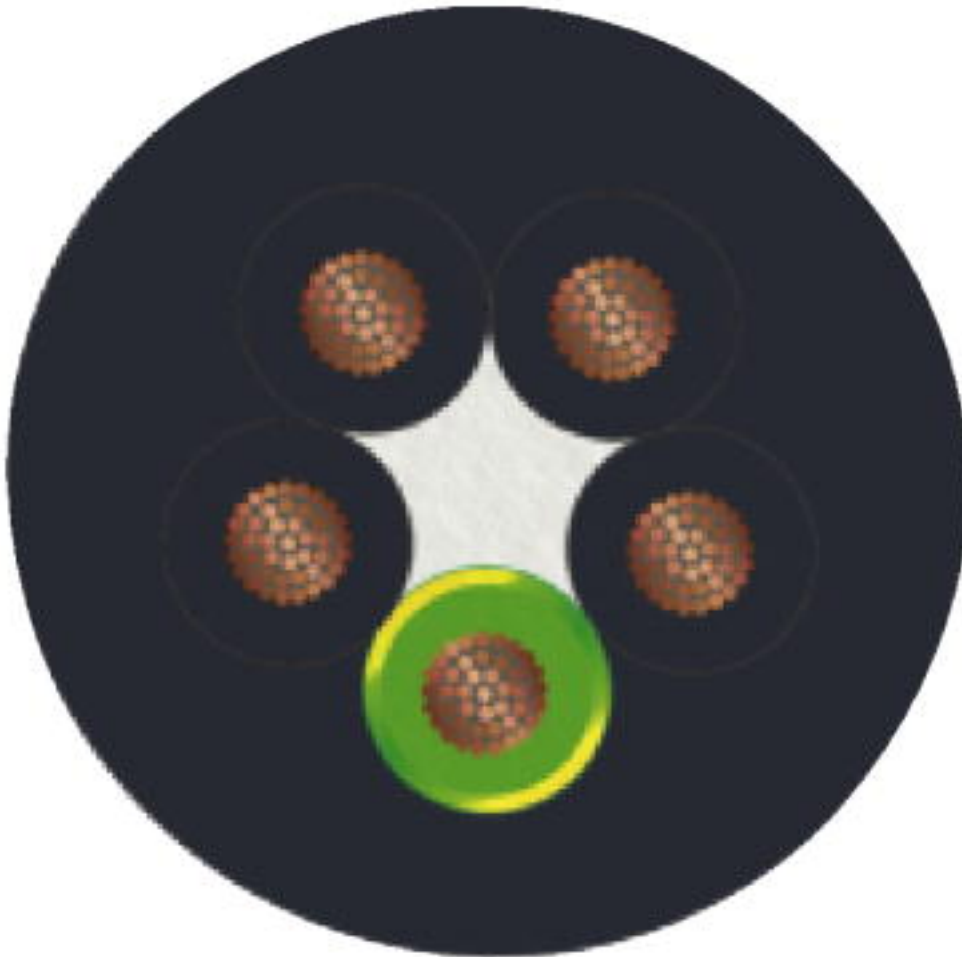

PUR halogen-free black [PUR]

© Phoenix Contact 2013 - all rights reserved
<http://www.phoenixcontact.com>