

Ring cable lug - C-RC 2,5/M5 DIN - 3240079

Please be informed that the data shown in this PDF Document is generated from our Online Catalog. Please find the complete data in the user's documentation. Our General Terms of Use for Downloads are valid (<http://download.phoenixcontact.com>)



Ring cable lug, non-insulated, 1.1 - 2.5 mm², M5

Product Features

- The CRIMPFOX-RC... tools from our CRIMPFOX range of crimping pliers are available for optimum crimping
- The ring cable lugs without plastic sleeve are made from high-quality tin-plated electrolytic copper for maximum protection against corrosion
- The hard-soldered press zone enables maximum conductor pull-out values to be achieved

Key commercial data

package_quantity	100
GTIN	4046356452960

Technical data

Dimensions

Length (b)	19 mm
Width (a)	10 mm
Length of insulation sleeve (c)	5 mm
Inner dimension of the insulating collar (d)	2.3 mm
Distance between the center and the insulation sleeve (e)	9 mm
Inner diameter (f)	5.3 mm
Material thickness (g)	0.8 mm

Ambient conditions

Ambient temperature (operation)	110 °C
--	--------

General

Color	silver
Stripping length	8 mm
Material	Copper

classifications

eCl@ss

eCl@ss 4.0	27060701
eCl@ss 4.1	27060701

Ring cable lug - C-RC 2,5/M5 DIN - 3240079

classifications

eCl@ss

eCl@ss 5.0	27400201
eCl@ss 5.1	27400201
eCl@ss 6.0	27400201
eCl@ss 7.0	27400201
eCl@ss 8.0	27400201

ETIM

ETIM 2.0	EC000005
ETIM 3.0	EC000005
ETIM 4.0	EC001052
ETIM 5.0	EC001052

UNSPSC

UNSPSC 6.01	30211923
UNSPSC 7.0901	27121703
UNSPSC 11	27121703
UNSPSC 12.01	27121703
UNSPSC 13.2	27121703

Drawings

Ring cable lug - C-RC 2,5/M5 DIN - 3240079

Dimensioned drawing

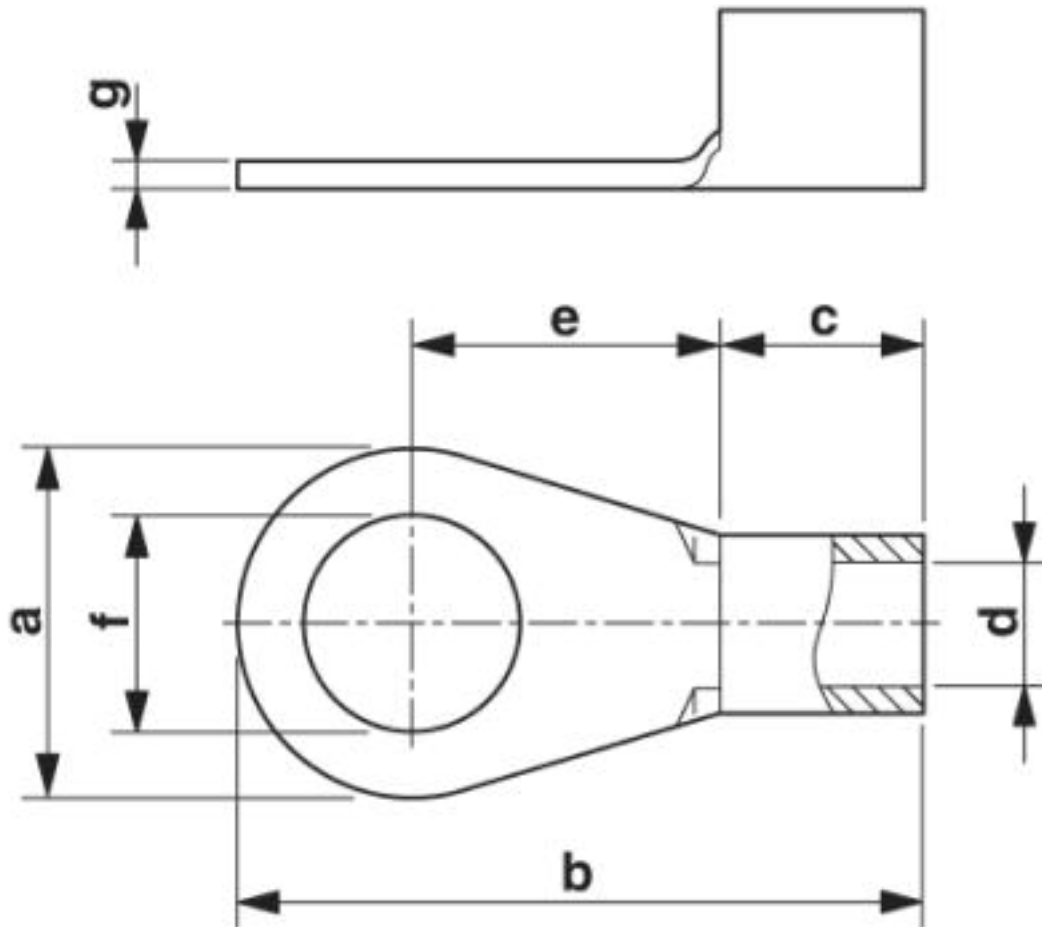

© Phoenix Contact 2013 - all rights reserved
<http://www.phoenixcontact.com>