

# AEROTEC

MINI HVLP paint spray gun

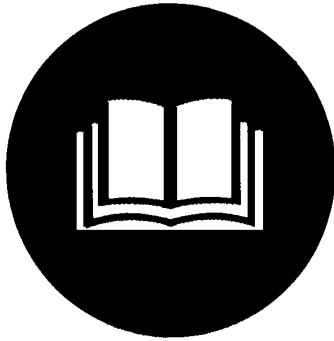

English



Art. no. 2005700





CE

Please read this operating manual carefully  
prior to commissioning the device.

EN	Complaints/spare-part orders will be processed quickly and unbureaucratically. Please use the following contact details		
	Phone: +49 61 82 / 99387- 0	Fax: +49 61 82 /99387 - 20	E-mail: info@aerotec.info

**Labelling:**



**Product safety - prohibition signs:**

			
According to European Union standards	Prohibition sign	Wearing loose-fitting clothes is prohibited!	Wearing jewellery etc. is prohibited.

**Warning - mandatory signs:**

			
ATTENTION/WARNING	Observe operating instructions	Wear hearing protection	Wear protective goggles

**Environment safety:**

		
Do not dispose of waste into the environment	Cardboard packaging can be returned to the designated recycling points.	Damaged and/or disposable electric or electronic equipment must be returned to the designated recycling points.

**EC Declaration of Conformity**

Herewith, we,  
pro)SALES GmbH  
Ferdinand-Porsche-Straße 16  
63500 Seligenstadt  
Germany

declare that the devices described below, on the basis of their design and construction, as well as in the version that we have placed on the market, corresponds with the relevant fundamental health and safety requirements of the EC directives.

**This certificate becomes void if the devices are modified without our approval.**

Device designation:  
Aero MINI HVLP paint spray gun Art. no. 2005700  
Date/Manufacturer signature: 16/11/2010



**Relevant EC directive:**  
2006/42 EG

**Applied harmonised standards:**  
EN 792; EN 50144

Device:

MINI HVLP paint spray gun

Specifications:

MINI HVLP paint spray gun
<b>Operating pressure: 1,5 - max.3 bar</b>
<b>Air consumption: 120 l/min</b>
<b>Air connection: SK</b>
<b>Gravity cup volume: 125 mm</b>
<b>Suppl.hose diameter:6 mm</b>
<b>Article no. 2005700</b>

Delivery scope:

1 x HVLP paint spray gun / 0.8 mm nozzle  
1 x Nozzle set 0.5 mm  
1 x Operating manual

General safety information:



**Safety information!**  
**Failure to observe the following information may lead to injuries.**

Read the pneumatic tool instructions very carefully prior to commissioning.

All operators must be fully and sufficiently informed on how to operate pneumatic tools.

Only qualified and trained technicians are allowed to carry out servicing and repair work.

Paint spray guns may only be used in a well ventilated working environment. During paint spraying, always wear a paint mask.

Make sure that you have a stable and secure standing position prior to using the tool.

Check the pneumatic hose and all connections regularly for signs of wear or damage.

Hold the tool by the handle only, never by the hose.

Never exceed the recommended maximum operating pressure (3 bar)

The tool is neither earthed nor electrically insulated.

Never use the tool where it could come into contact with electricity.

It is advisable to disconnect the air supply when replacing paint spray nozzles; The release must not be actuated during this process.

If you notice any malfunctions or irregular power prior to use, stop using the tool immediately and

maintain or repair the tool.

Do not use overly long hoses which may pose tripping hazards.

Read the compressor operating manual and observe the safety instructions for operating the compressor.

**ALWAYS** use certified protective goggles and hearing protection.

Take off watches, rings or other interfering items.

Loose clothing or jewellery could get entangled in the air compressor or the air device which could cause severe injuries.

The trigger must not be operated when the device is connected to the air supply.

Disconnect the air supply from the device when it is not in use.

**NEVER** replace accessory parts and **NEVER** execute maintenance work when the device is connected to the air supply.

Maintain the device thoroughly and follow the instructions on lubrication and maintenance.

Do not damage the hoses and connectors by carrying the device by the hose or disconnecting the hose by tugging from the air supply.

Prevent the hose from being exposed to heat or sharp edges. The hose should be replaced if it is damaged or worn.

**NEVER operate the device with an air pressure exceeding 3 bar.**

Use a pressure regulator that reduces the pressure to 3 bar.

Operate the device at a safe distance from people and animals  
**AT ALL TIMES.**

Prior to start-up:

**Air supply:**

Make sure to use a water trap to ensure an optimum spray pattern

**Assembly:**

Ensure that the nozzle is properly attached and slightly lubricate the sealings after cleaning the spray gun to keep the sealing rubber smooth.



**Safety information!**

**Wear protective goggles!**

**Wear hearing protection!**

Make sure that only compressed air free of condensate is used for operation.

It is sufficient to slot in a water trap filter.

Start the air compressor.

The maximum operative air pressure for the tool is 6.3 bar; The operative pressure can be adjusted via a pressure regulator at your compressor.

We recommend setting the operating pressure while test spraying to ensure optimum settings.

This way, pressure differences can be compensated for.

Maintenance and care:

**Cleaning:**

Complying with the maintenance instructions specified in this section ensures a long service life and faultless operation of this high quality product.

Carefully clean and maintain the paint spray gun immediately after paint spraying.

Cleaning the paint spray gun ensures faultless handling when next using it.

**Do not use hydrocarbon halogen solvents (1.1.1 Trichloromethyl, Chloromethane etc.) as these lead to hazardous chemical reactions with certain materials of the paint spray gun.**

**Caution!**

**Do not immerse the paint spray gun completely in a solvent bath as this may destroy the sealings.**

Problem:	Possible causes:	Corrective actions:
The paint spray jet is interrupted or intermittent:	1. Insufficient paint in the container:	Fill it.
	2. Holding the spray gun at an angle:	Change angle.
	3. Blocked paint line:	Clean it.
	4. Loose / damaged nozzle:	Tighten or replace the nozzle set.
	5. Excessive viscosity:	Reduce viscosity.
	6. Blocked opening in the cover:	Clean it.
	7. Worn needle sealing or loose core:	Replace and adjust the needle.
	8. Insufficient operating pressure (flow pressure):	Increase operating pressure (flow pressure).
Incomplete spray pattern:	1. Air head contaminated or damaged:	Clean or replace the complete nozzle set.
	2. Paint is sticking to the nozzle or parts are damaged:	Clean or replace the complete nozzle set.
	3. Nozzle needle damaged:	Replace complete nozzle set.
Irregular paint pattern with drops:	1. Nozzle contaminated or damaged:	Clean or replace the complete nozzle set.
	2. Increase operating pressure (flow pressure):	Increase operating pressure (flow pressure).
	3. Excessive viscosity:	Reduce viscosity.
	4. Contaminated air head:	Clean air head.
Irregular material accumulation:	1. Excessive operating pressure:	Reduce operating pressure (flow pressure).
	2. Paint blocks the air head and the nozzle:	Clean it.

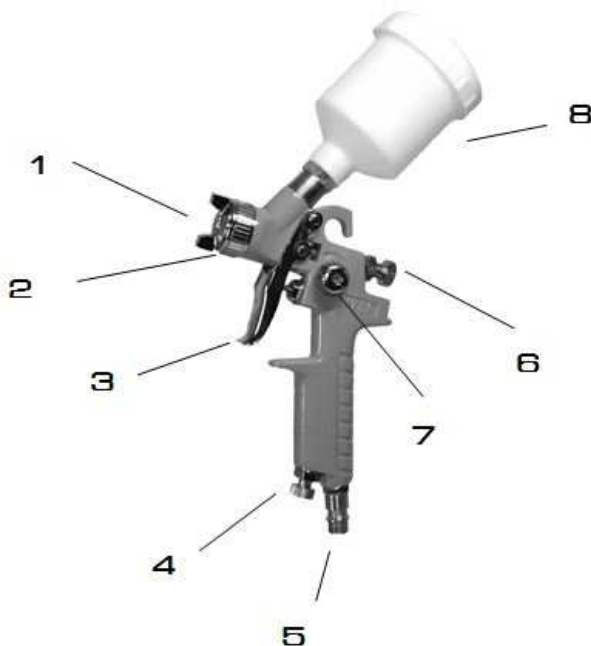

**Details:**

1. Nozzle head
2. Nozzle thread
3. Operating lever
4. Fine adjustment
5. SK connector
6. Paint flow control
7. Air flow control
8. 125 ml gravity cup