

# GIRA

## Device description

The Gira RDS flush-mounted radio consists of a radio insert with operating top unit and loud-speaker insert with cover plate. Either one or two loudspeakers can be connected to the radio insert. The radio automatically detects connected loudspeakers and switches over between stereo and mono mode. The radio is installed in conventional flush-mounted device boxes. Operation of the radio is via capacitive operating buttons. The operating top unit is equipped with a display showing the station text (RDS) etc. External music sources, for example an MP3 player, can be fed into the radio via an AUX input.

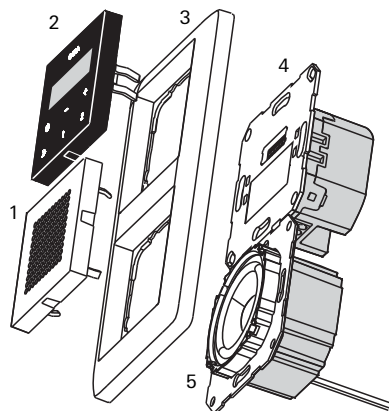

- 1 Loudspeaker cover
- 2 Operating top unit
- 3 Cover frame, 2-gang
- 4 Radio insert
- 5 Loudspeaker insert

## Display

In normal operation, the display shows the station name, frequency and time. Display of time is coupled to the RDS signal received and cannot be set manually.

With weak station signals, the station name and time may not be displayed. Instead of this the station frequency is shown in the display.

### Information on RDS text

In some cases, the texts shown on the display may differ from the texts transmitted by the station.

Unexpected texts may be displayed when unsupported characters are received. This is not a malfunction.



Further display information:

- **1 / 2**: the radio displays a saved station
- **Sleep**: the radio is in sleep mode
- **> > >**: the radio carries out an automatic station search
- **AUX**: the radio generates an audio signal fed in via the AUX input
- **INIT**: the radio carries out initialisation
- **VOLUME**: displayed during volume adjustment

## Operation



Operation only requires a light touching of the symbols.

An overview of the most important functions:

-  a quick press switches the radio on/off; a long press switches the radio into sleep mode.
- >>** a quick press starts manual station search; a long press starts automatic station search;
- + / -** pressing **-** lowers the radio volume; pressing **+** makes it louder.
- 1 / 2**: a quick press calls up a saved station; a long press saves stations.

## Switching on the radio

Any button can be pressed to switch on the flush-mounted radio. It is not necessary to specifically press .

When switching on, the last station listened to is switched on with last selected volume.

The radio remains switched on until it is switched off by pressing .

### Switching on automatically

The RDS flush-mounted radio can be switched on with an external switch, for example in combination with room lighting. This so-called auxiliary unit function is however dependent upon the individual installation environment of your house or flat. Ask your electrical installer whether auxiliary unit functionality can be carried out in your home.

## Setting volume

Volume is set via **+** and **-**.

Volume is raised with **+**, and lowered with **-**.

During setting, the current value of volume is shown by the display:

**VOLUME 1** for the lowest level, and **VOLUME30** for the highest level.

### Volume when switching on

When switching on, the last station heard with the last selected volume is called up.

## Searching a station

To initiate the automatic station search function, press and hold the **>>** search button. During the search the radio is muted and **> > >** is shown in the display. As soon as a station is located the search function stops and the station becomes audible.

To manually search for a station: Briefly press **>>** several times until the desired frequency is located. Each press of the button increases the frequency by 0.1 MHz.

### Station search

The search direction is ascending. If the upper frequency limit (107.9 MHz) is reached, the radio switches to the lower frequency limit (87.5 MHz) and continues searching. If the search returns to the initial frequency, the radio switches automatically to a higher sensitivity level. In this way, weaker stations may also be received.

## Saving a station

The RDS flush-mounted radio has two station presets, each of which can save a station setting.

Saving:

1. Select the desired station with the station search function.
  2. Press the corresponding memory button (**1** or **2**) for approx. 2 seconds.
- ✓ If the station is saved the radio is muted and the memory number is shown in the display.

### Reprogramming the memory

If the station preset is occupied by a station, this is then reprogrammed with the new station.

## Calling up a station

Briefly press a memory button (**1** or **2**) for calling up a pre-set station. The pre-set station is located and the corresponding memory number is shown by the display.

## Sleep mode

In sleep mode the radio switches off automatically after 30 minutes.

To activate sleep mode, press  for approx. 2 seconds when the radio is switched on until **Sleep** is shown by the display.

To deactivate sleep mode, briefly press . The **Sleep** display is suppressed.

## Using an external audio source

### Installation note

For connecting an external audio source, a cinch socket outlet must be installed in addition to the flush-mounted radio. Ask your electrical installer whether this function can be carried out in your home.

The RDS flush-mounted radio is able to generate the audio signals of an external source (e.g. an MP3 player).

This function is demonstrated with an MP3 player in the following example:

1. Connect the MP3 player via a suitable adapter cable (e.g. cinch - jack) to the cinch socket outlet.
  2. Switch on the MP3 player and start playback.
- ✓ The RDS flush-mounted radio switches automatically to AUX mode:
- **AUX** appears in the display,
  - the music from the MP3 player is generated via the radio loudspeaker.

### Note

If the flush-mounted radio does not switch automatically to AUX mode, the volume of the connected device must be increased.

In individual cases it may occur that the maximum output level of the connected device is insufficient to initiate AUX mode. In this case the device cannot be operated with the flush-mounted radio.

3. The volume can be modified as accustomed via **+** and **-**; the buttons **>>**, **1** and **2** have no function in AUX mode.

4. For switching off or for changing to radio operation the MP3 player is simply switched off.

- ✓ When the MP3 player is switched off, the radio returns to its state of play prior to switching to AUX mode after 10 seconds.

### Note

The waiting time of 10 seconds is required so that the flush-mounted radio does not inadvertently leave AUX mode because of quiet passages between music titles.

## Installation

### Important

Installation and mounting of electrical devices may only be carried out by a qualified electrician.

The RDS flush-mounted radio must be installed protected from dripping and sprayed water in indoor areas.

Electronic devices cause interference signals which may be picked up by radios. Reception interference may therefore result in combination with electronic devices in one installation unit or in close proximity (e.g. ballasts). For this reason, carry out a functional check on-site before installing such a combination. Interference can be minimised by increasing the distance between the devices.

The inserts of the flush-mounted radio can be installed in flush-mounted device boxes one below the other or next to each other as desired:

1. Install the loudspeaker insert and lay the connection cables of the loudspeaker insert in the flush-mounted device box of the radio insert.

### Support ring seal

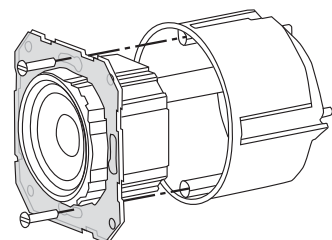

The support ring of the loudspeaker insert is coated with a film that provides acoustic isolation of the insert from the front sound opening. This support ring seal **must not be removed** and, apart from holes caused by the attachment screws must **not be damaged**, as otherwise bass reproduction may be impaired.

2. Connect the power supply (230 V) to the L/N terminals of the radio insert.
3. Connect the auxiliary input (1) if required (see "Auxiliary unit function").
4. Connect the loudspeaker connection cables to the radio insert (see "Loudspeaker connection").
5. Install the radio insert into the flush-mounted device box.
6. Remove the protective cover from the loudspeaker insert.
7. Apply the cover frame and attach the loudspeaker cover and operating top unit.

### Initial start-up

When switching on for the first time initialisation begins automatically:

- The display shows **INIT** and a progress bar.
- The radio generates two tones to determine the number of loudspeakers.
- The two strongest stations are automatically stored in the station presets 1 and 2.

## Loudspeaker connection

Either one or two loudspeakers can be connected to the RDS flush-mounted radio:

Terminal	Connection cable
+	red
-	black

The maximum cable length between the loudspeaker and radio insert is 20 m.

### Mono operation

If only one loudspeaker is connected, sound is generated in mono quality.

With connection of only one loudspeaker the **left channel (L+ / L-)** must be used. Loudspeaker impedance must not exceed 4 ohms.

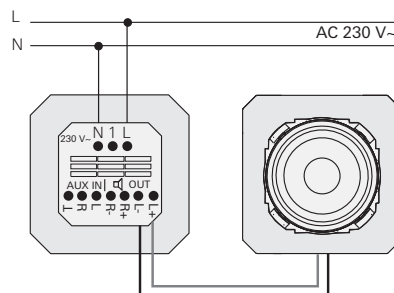

### Stereo operation

If two loudspeakers are connected to the flush-mounted radio, the radio signal is generated in stereo quality.

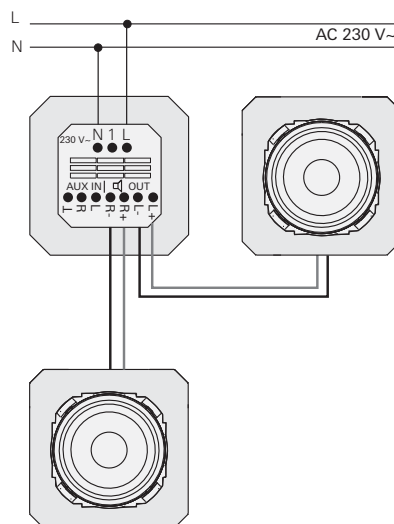

### Retrofitting a second loudspeaker

If a second loudspeaker is connected to the flush-mounted radio at a later date, initialisation must be manually triggered (see 'Manual initialisation').

## Auxiliary unit function

The RDS flush-mounted radio is equipped with an auxiliary input. This for example enables switching of the radio via a switch or automatic control switch together with room lighting. For this purpose, the switched phase is laid from the switch to the auxiliary input (1) of the radio.

### Use the same phase

The same phase L must be used for the auxiliary input (1) and the power supply of the radio insert (L).

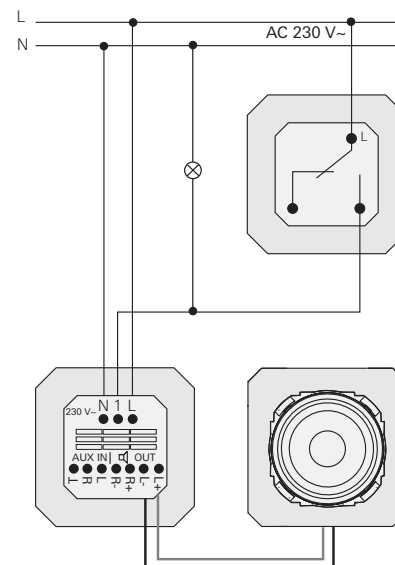

If no permanent phase exists in the room, connection of the flush-mounted radio can alternatively be carried out via the switched phase. In this case however the flush-mounted radio may only be operated with lighting switched on.

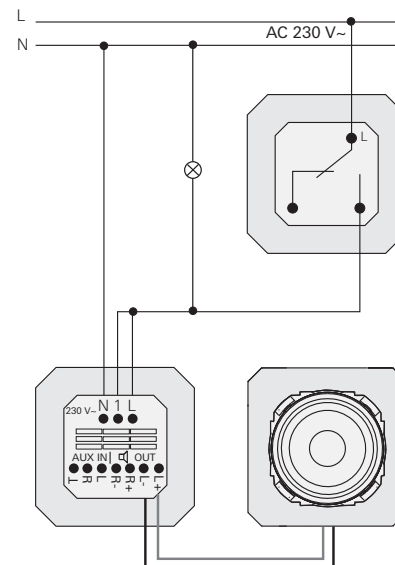

## Connection of AUX input

The RDS flush-mounted radio is equipped with an AUX input via which external music sources such as MP3 players can be connected. For this purpose an additional cinch socket outlet is connected to the AUX IN terminals of the RDS flush-mounted radio. The maximum cable length between the cinch socket outlet and radio insert is 3 m.

The external music source is then connected to the RDS flush-mounted radio with an adapter cable (e.g. cinch - jack) via the cinch socket outlet.

Upon switching on the external music source, the RDS flush-mounted radio automatically switches to AUX mode and generates the signal of the external source.

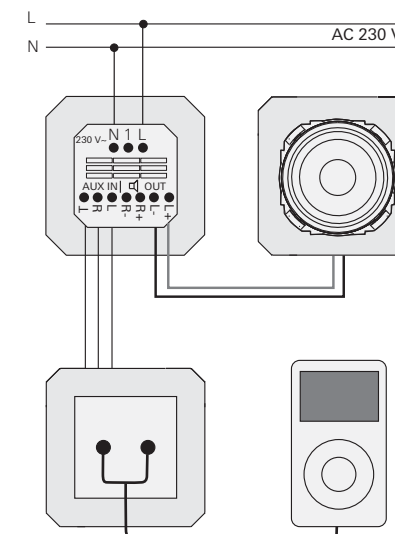

## Manual initialisation

With initial start-up the RDS flush-mounted radio automatically carries out an initialisation that determines the number of connected loudspeakers and adapts the antenna to site conditions etc.

### Information on improving reception

With poor reception conditions, reception can be improved by extending the **left-hand loudspeaker cable (L+/L-)** to 75 cm if installation conditions permit.

If a second loudspeaker is connected at a later date or the flush-mounted radio is installed at a new location, initialisation must be triggered manually:

1. Press the buttons **>>** and **2** simultaneously and hold for at least 5 seconds until the flush-mounted radio is muted.
- ✓ Initialisation proceeds:
- The display shows **INIT** and a progress bar.
  - The radio generates two tones to determine the number of loudspeakers.
  - The two strongest stations are automatically stored in the station presets 1 and 2.

## Technical data

Operating voltage: AC 230 V  
 Temperature range: - 5 °C to + 50 °C  
 Humidity: 25 to 90 %  
 Frequency range: 87.5 to 107.9 MHz  
 Protection type: IP 20  
 Connection terminals  
 Mains connection: 2.5 mm<sup>2</sup> screw terminals  
 Loudspeaker-/AUX: 1.5 mm<sup>2</sup> screw terminals  
 Permissible loudspeakers  
 Impedance: 4 to 16 ohms  
 Input impedance  
 AUX input: 47 kohms  
 Maximum cable lengths  
 Loudspeaker: 20 m  
 AUX connection: 3 m

## Loudspeaker

Impedance: 8 ohms  
 Rated load: 4 W  
 Connection cable: 150 mm

## Warranty

We provide a warranty in accordance with the statutory requirements.

Please send the device postage paid with error description via the specialist trade to our central customer service centre.

Gira  
Giersiepen GmbH & Co. KG  
Service Center  
Dahlienstraße 12  
42477 Radevormwald