

ELECTRONIC SWITCH FOR SUN BLINDS

for flush-mounting

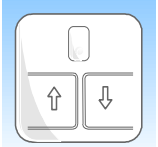

The switches for sun blinds are manufactured in accordance with the latest technological facts and are subject to continuous quality controls.

Please read the installation and operating manual carefully to avoid mistakes and ensure proper functioning.

General description:

The microprocessor controlled sun blind switch can be used to control motor-driven roller blinds and sun blinds with limit switches (230V / 50Hz motors). The manual up / down / stop function is activated by simply touching the keys. By pushing the up / down keys for 3 seconds, an up and a down motion time can be programmed which is repeated in a 24 hour cycle. Due to the 50 x 50mm central plate in accordance with DIN 49075, it can be integrated into almost all common switch programs with the respective intermediate frames.

- very simple programming
- 24 hours automatic function
- emergency power backup in the case of power failure
- no clock needs to be set
- programming lock
- simple formation of groups possible

External inputs: Extension unit operation, formation of groups

All kinds of 230V signal transmitters, such as push buttons, time switches, photoelectric lighting controllers, wind sensors etc. can be connected to the inputs "Extern ↑" and "Extern ↓". It is essential to always connect the same L-conductor which is connected to the blind switch.

It is possible to combine several blind switches to one group by simply connecting the external inputs in parallel. These groups can then also be controlled centrally via push buttons, time switches or a blind switch as well (Fig. 2 and 4). As signals which are present for a longer period of time are also evaluated as a short impulse, no other functions are blocked. For this reason, it is possible to connect even customary signal transmitters with extended signal duration (e.g. time switches, shortest switching time usually 1 min.) to these inputs.

Technical data:

Mains voltage: 230V~, +6/-10%, 50Hz
 Switching capacity: max. 750VA
 max. motion time: 180s

In the case of a power failure, the performed programming will be saved for max. 60 minutes. The device, however, must have been in operation for at least 20 minutes while the mains voltage was available.

Installation and safety instructions:

- The blind switch can be installed into all customary flush boxes with Ø 60mm and can be used with 50x50mm central plates in accordance with DIN 49075.
- Per blind switch, **only one motor** may be connected (refer to the motor manufacturer's instructions). If more than one motor is connected to the blind switch, use appropriate cut-off relays.
- Always **the same phase** which is connected to the contact "L" must be connected to the inputs "Extern ↑" and "Extern ↓". The maximum wire length at these inputs should not exceed 100m.

- Please make sure that there are no persons or objects in the motion range of the blinds.
- Regarding electronic tubular motors, refer to the manufacturer's instructions concerning the programming line.



Works at the 230V mains supply must only be carried out by a specialist under consideration of the valid regulations (e.g. DIN-VDE). All works must only be carried out when the mains voltage is switched off. If the device is opened or tampered with, the warranty will expire.

Assembly

1. Switch off the power supply and secure it against being switched on.
2. Connect the device according to the connection diagrams (stripping length of wires 8mm).
3. Use mounting claws or screws to fix the device in the flush box.
4. Screw on cover frame, intermediate frame and central plate.
5. Attach lens.
6. Switch on power.

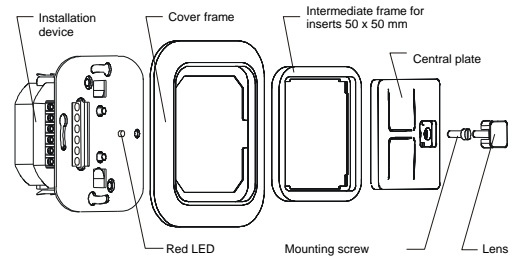

The accompanying different-sized pegs can be used to compensate differences in height due to plaster or wallpapers (wallpaper compensation) or the differences in height caused by the use of different switch programs.

Help in case of malfunctions:

Error occurred:	Possible causes / measures:
The blinds move into the wrong direction when the keys ↑ and ↓ are actuated	<ul style="list-style-type: none"> • motor connectors wrong, swap the connectors at the outputs "Motor ↑" and "Motor ↓"
When the blinds are operated via the external inputs, they move into the wrong direction	<ul style="list-style-type: none"> • Swap the connectors at the inputs "Extern ↑" and "Extern ↓"
The blind does not move	<ul style="list-style-type: none"> • Due to a previous operation, the blind motor has become too hot (the thermal protection of the motor has triggered) – wait for a couple of minutes • No mains voltage available – check fuse • The blind motor is defective - replace • The blind switch is defective - replace
If disturbances from the mains (e.g. switching processes) affect the function of the device temporarily, a motion which is possibly being carried out is stopped. Afterwards, regular operation is again possible.	

Operation of the blind switch:

Requested function:	What to do:		Explanation:
	① key ↑ (up) or ↓ (down)	② input "Extern ↑" or "Extern ↓"	
1. Move blind "Up" ↑ or "Down" ↓	①	At a push of the respective key, the motion time is triggered and the blind moves to its stop position (stop depends on the setting of the motor's limit switches). The maximum motion time is 180 seconds. Then, the drives are de-energized.	If an automatic function has been programmed beforehand, the red LED will glow for 5 seconds when the blind is moved. Manual commands at the arrow keys ↑ and ↓ always have priority over the automatic function and signals at the inputs "Extern ↑" or "Extern ↓".
	②	Switch signal to the respective input.	
2. Stop moving blind	①	Shortly actuate any key, ↑ or ↓	This means that a blind moving in this direction ↓ can only be stopped by a signal at "Extern ↑"
	②	Apply signal to the opposite input.	
3. Perform programming Activate automatic function	①	At the desired time of day, push e.g. the key ↑ (up) until the red LED blinks (at least 3 seconds). (Perform the same with key ↓ (down) at the desired time of day).	When the key is actuated, the blind starts to move and the LED glows. As soon as the LED starts to blink, the key can be released. Now, the movement in the direction which has just been carried out is saved for this time of day. The blind will now move into the respective direction every day at the programmed time.
	②	The programming cannot be carried out via the external inputs.	
4. Change a programmed time	①	The easiest way to change a programmed time is to overwrite it. To do so, follow the steps in point 3.	The previous automatic time is replaced by the newly programmed time.
5. Temporarily deactivate the automatic function (the programmed ↑(up) / ↓(down) times will be saved)	①	Push the keys ↑ (up) and ↓ (down) simultaneously and keep them pushed for at least 3 seconds until the red LED blinks. (By pushing them again for 3 seconds, the automatic function can be restarted.)	When the keys are pushed simultaneously, the red LED glows. When it has recognized the command, the LED blinks for 5 seconds. The temporary deactivation of the automatic function always applies to both directions of movement.
6. Lock device against unauthorized programming change	③	<i>Permanently</i> turn the setting screw from position "0" to position "lock".	Now, the device cannot be programmed. An existent automatic function will still be carried out.
7. Permanently delete programmed ↑ / ↓ times (automatic function is deactivated)	③	<i>Shortly</i> turn the setting screw from position "0" to position "delete". Then, turn it back to position "0".	
8. Check if the automatic function is activated	①	Shortly actuate the key ↑ or ↓	If the automatic function is programmed and activated, the red LED glows for 5 seconds when the blind is moved. (The automatic function may also be deactivated temporarily, see 5.)

Fig. 1: Individual control of a sun blind

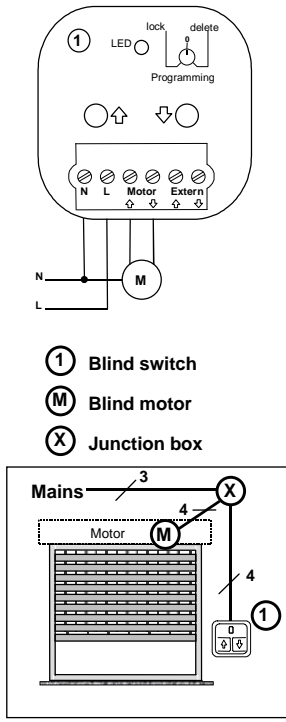

Fig. 2: With blind switch 1, a group of further devices in any amount can be controlled centrally (manually or with program). Blind switches 2 and 3 control individually on the spot (manually or with program).

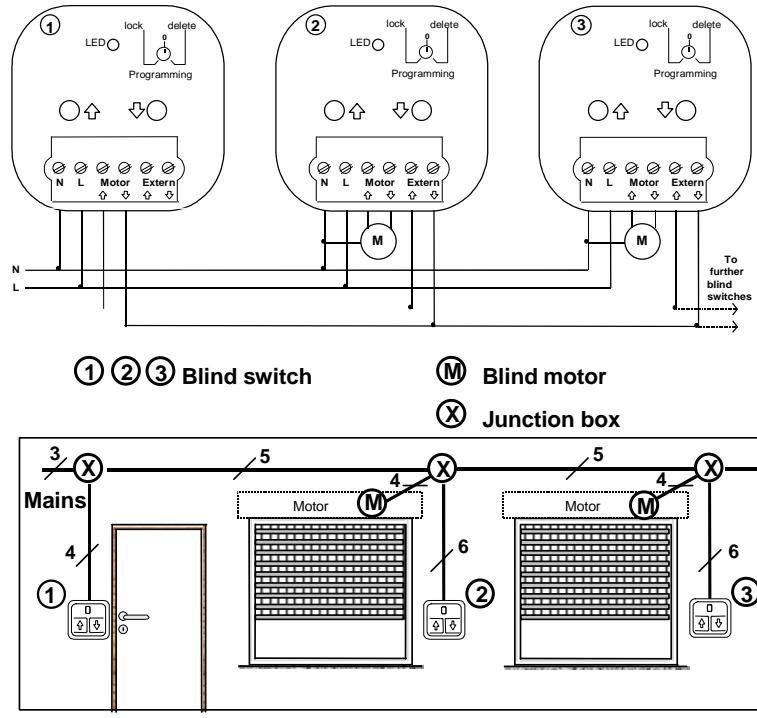

Fig. 3: Additional control option of the blind switch via one or several extension units. The blind can be activated from all units.

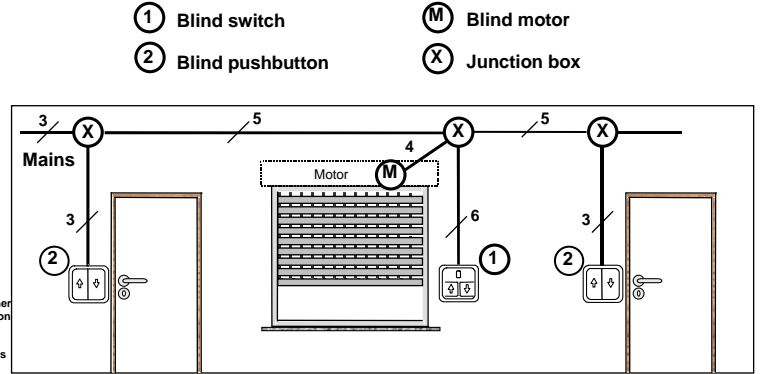
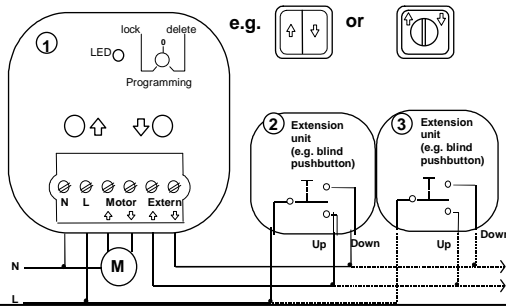

Fig. 4: Control across two or several floors. Blind switch 1 controls centrally a group in any amount of further devices, even across several rooms. The blind switches 2 and 3 can be actuated individually on the spot. Via the blind pushbutton (master unit) on the 1st floor, all blind switches can be controlled centrally.

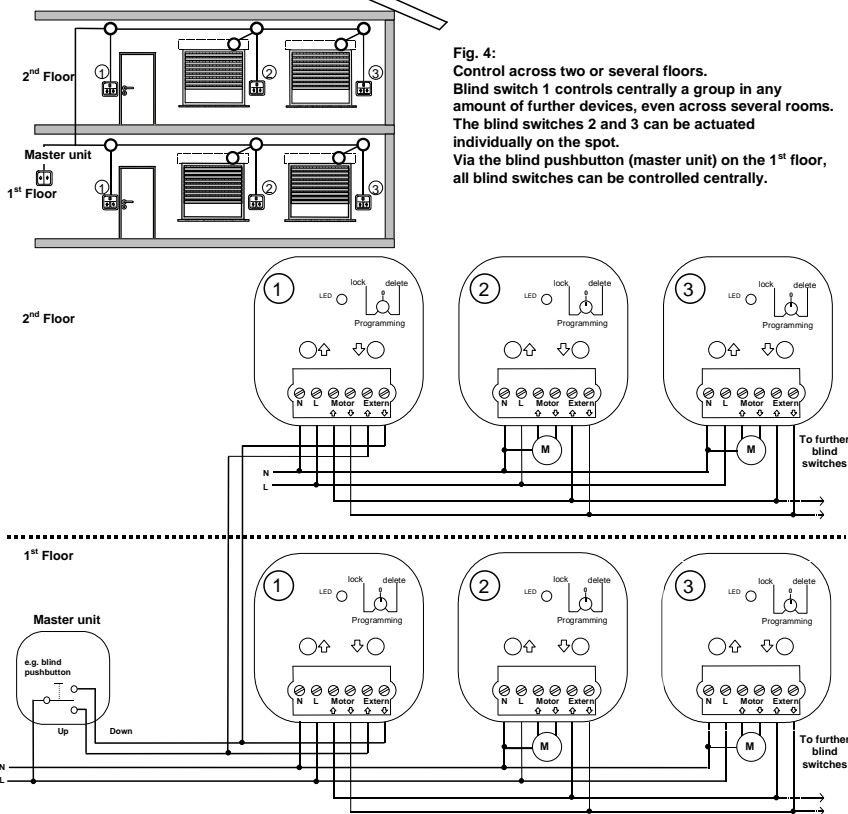

Fig. 5 The blind switch follows each control device which supplies a 230V signal to the inputs "Extern ↑" and "Extern ↓".

