

2/2 way Globe Valve for media up to +180 °C, DN10-100



- Compact globe valve version
- Flange, threaded and welded ports as standard
- Stainless steel 316L valve body
- Available with flow direction below and above seat

Type 2012 can be combined with...



Typ 8697

Electrical position feedback

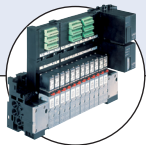

Type 8640/8644

Valve block



Type 6012/6014 P

Pilot valve



Type 5470

Solenoid valve

For process valves with decentralized automation see ELEMENT Type 2101



The externally piloted globe valve consists of a pneumatically operated piston actuator and a 2/2 way valve body. The actuator is made of PA or, for special operating conditions, PPS. The reliable self-adjusting packing gland provides high sealing integrity. These maintenance-free and robust valves can be retro-fitted with a comprehensive range of accessories for position indication, stroke limitation or manual override.

²⁾ **Note:** For PA actuators in the sizes 40, 50 and 63, the combination of max. media temperature and max. ambient temperature is as shown in the following chart:

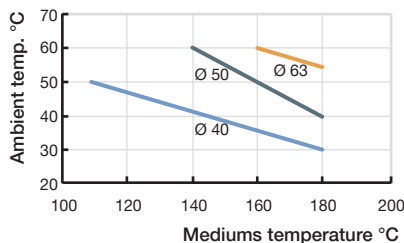

Technical data	
Orifice	DN10 ... 100
Body material	Cast stainless steel 316L
Actuator material	PA, PPS
Seal material	PTFE (NBR, FKM and EPDM on request)
Medium	Water, alcohol, oils, fuel, salt solution, alkali solutions, organic solvents, steam
Viscosity	Max. 600 mm ² /s
Packing gland (with silicone grease)	PTFE
Nominal pressure	PN25 (body)
Medium temperature²⁾	-10 ... +180 °C with PTFE seal
Ambient temperature PA actuator¹⁾	
Actuator sizes up to Ø 125	-10 ... +60 °C
Actuator sizes Ø 175 ... 225	-10 ... +50 °C
PPS actuator	
Actuator sizes Ø 40 ... 80	+5 ... +140 °C
Actuator sizes Ø 100 ... 125	+5 ... +90 °C
Installation	As required, preferably with actuator in upright position
Control medium	Neutral gases, air
Max. pilot pressure	
Actuator size Ø 40 ... 80	PA and PPS 10 bar
Actuator size Ø 100	PA 10 bar
Actuator size Ø 100	PPS 7 bar
Actuator size Ø 125	PA and PPS 7 bar
Actuator size Ø 175 ... 225	PA 6 bar

Content



Valve specifications

Type 2012

Technical data & ordering info.

p. 1-14



System spec. On/Off Classic

Type 8801-GA

Ordering info. & technical data

p. 15-16

Request for quotation

Type 8801-GA

p. 17

Materials

Actuator size 40 ... 125 mm

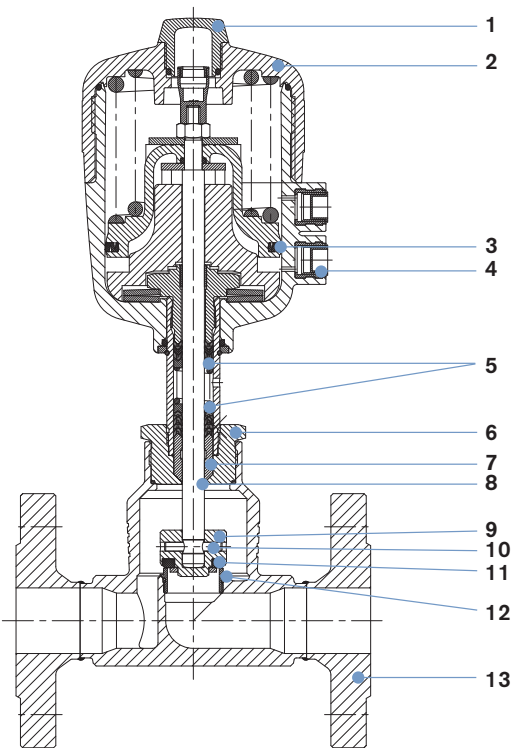

- | | | | |
|----|----|-----------------|--|
| 1 | 1 | Transparent cap | PC, PSU |
| 2 | 2 | Actuator | PA, PPS |
| 3 | 3 | Cylinder seal | NBR, FKM |
| 4 | 4 | Pilot air ports | Stainless steel 1.4305 |
| 5 | 5 | V-seals | PTFE, FKM |
| 6 | 6 | Nipple | Stainless steel 1.4401 |
| 7 | 7 | Wiper | - PTFE |
| 8 | 8 | Spindle | - PEEK Actuator size 100 mm and 125 mm
Stainless steel 1.4401 |
| 9 | 9 | Swivel plate | Stainless steel 1.4401 |
| 10 | 10 | Pin | Stainless steel 1.4401 |
| 11 | 11 | Seal | PTFE (NBR, FKM, EPDM on request) |
| 12 | 12 | Valve seat | Stainless steel 1.4571 |
| 13 | 13 | Valve body | Stainless steel 316L |

Actuator size 175 and 225 mm

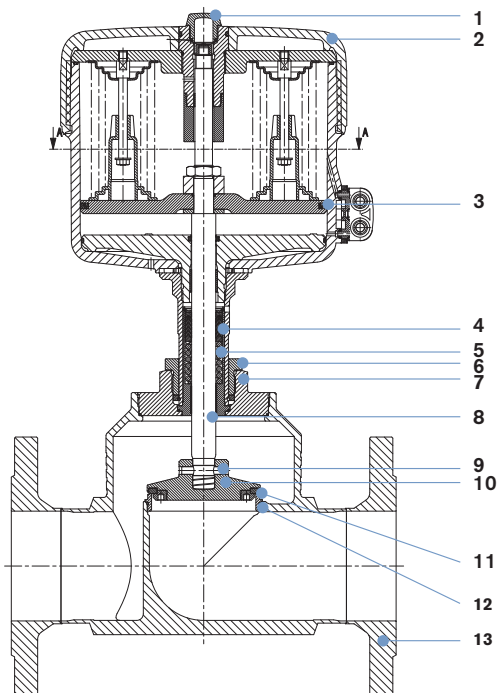

- | | | | |
|----|----|-----------------|----------------------------------|
| 1 | 1 | Transparent cap | PC |
| 2 | 2 | Actuator | PA |
| 3 | 3 | Cylinder seal | NBR |
| 4 | 4 | V-seals | PTFE |
| 5 | 5 | Spring | Stainless steel 1.4568 |
| 6 | 6 | Screw | Stainless steel 1.4305 |
| 7 | 7 | Nipple | Stainless steel 1.4404 |
| 8 | 8 | Spindle | Stainless steel 1.4401 |
| 9 | 9 | Pin | Stainless steel 1.4404 |
| 10 | 10 | Swivel plate | Stainless steel 1.4404 |
| 11 | 11 | Seal | PTFE (NBR, FKM, EPDM on request) |
| 12 | 12 | Valve seat | Stainless steel 1.4571 |
| 13 | 13 | Valve body | Stainless steel 316L |

Technical data for valves with flow direction below the seat

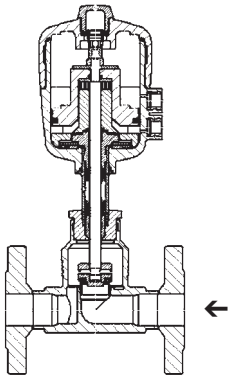

Flow direction below seat
Type 2012 with flange port connection

Orifice [mm]	Actuator size [mm]	K _v value water (m ³ /h)	Minimum pilot pressure CFA [bar]	Maximum operating pressure up to +180 °C		Weight with CFA Flange [kg]	Threaded port and weld end [kg]
				CFA [bar]	CFB [bar]		
10	40	4.7	4.0	15	16	2.3	0.8
	50	4.7	3.9	16	16	2.4	0.9
15	40	4.7	4.0	15	16	2.3	0.8
	50	4.7	3.9	16	16	2.4	0.9
20	40	8.1	4.0	6.5	16	3.1	0.9
	50	8.1	3.9	11	16	3.3	1.1
	63	8.1	4.5	16	–	3.7	1.5
25	63	13.0	4.5	11	16	4.6	2.0
	80	13.0	5.0	16	–	5.4	2.8
32	63	19.5	4.5	6	16	6.6	2.9
	80	19.5	5.0	14	–	7.4	3.7
40	80	31.0	5.0	9	16	8.4	4.2
	125	31.0	3.2	16	–	13.9	9.7
50	100	45.0	4.4	7.2	16	13.5	7.7
	125	45.0	3.2	10	–	15.6	9.8
65	125	73.0	5.6	12	16 (15*)	20.2	12.9
	175	73.0	4.5	16 (15*)	–	26	18.7
80	125	110.0	5.6	7.5	14 (12.5*)	24.5	16.1
	175	110.0	4.5	10	–	30	21.3
	225	110.0	3.3	16 (12.5*)	–	35.5	26.9
100	125	165.0	5.6	5	9	32.9	20.6
	175	155.0	4.5	7	14 (10*)	37.9	25.6
	225	155.0	4.8	16 (10*)	–	43.5	31.2

* acc. to the Pressure Equipment Directive 2014/68/EU for compressible fluids in Group 1 (hazardous gases and vapors in accordance with Article 4, paragraph (1), c), i), first dash)

Pressure charts for control function B and flow direction below the seat

DN10 ... 20

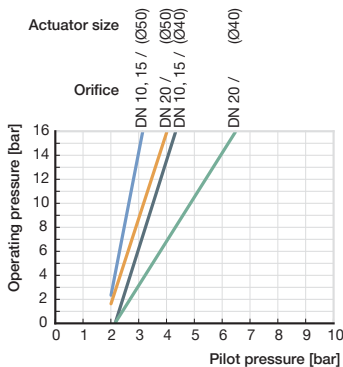

DN25 ... 50

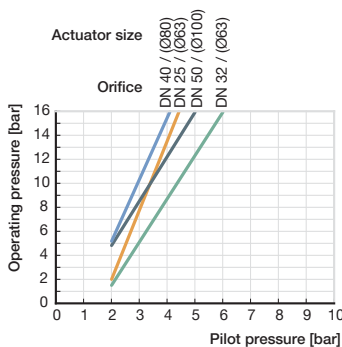

DN65 ... 100

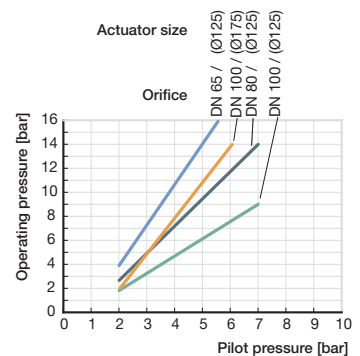

Ordering chart for valves with flow direction below the seat (other versions on request)

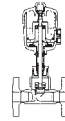

Valves with stainless steel body and flange connection according to DIN EN 1092-1, flow below seat

Control function	Orifice [mm]	Actuator size Ø [mm]	K _v value water [m ³ /h]	Minimum pilot pressure [bar]	Operating pressure up to +180 °C [bar]	Article no. PA actuator	Article no. PPS actuator
<p>Pneumatically operated on / off valve, normally closed by spring force, flow direction below seat</p>	10	40	4.7	4.0	15	146227	146362
		50	4.7	3.9	16	146237	146370
	15	40	4.7	4.0	15	146247	–
		50	4.7	3.9	16	146259	146378
	20	40	8.1	4.0	6.5	146271	–
		50	8.1	3.9	11	146283	–
		63	8.1	4.5	16	146295	146390
	25	63	13.0	4.5	11	146299	–
		80	13.0	5.0	16	146310	146398
	32	63	19.5	4.5	6	146314	–
		80	19.5	5.0	14	146322	146406
	40	80	31.0	5.0	9	146327	–
		125	31.0	3.2	16	146339	146414
	50	100	45.0	4.4	7.2	146345	–
		125	45.0	3.2	10	146357	146422
	65	125	73.0	5.6	12	152743	156476
		175	73.0	4.5	16 (15*)	152761	–
	80	125	110.0	5.6	7.5	155527	156484
		175	110.0	4.5	10	152779	–
		225	110.0	3.3	16 (12.5*)	152797	–
100	125	165.0	5.6	5	155546	156492	
	175	155.0	4.5	7.0	152815	–	
	225	155.0	4.8	16 (10*)	152833	–	
<p>Pneumatically operated on / off valve, normally open by spring force, flow direction below seat</p>	10	40	4.7	see charts page 3	16	146232	146366
		50	4.7		16	146242	146374
	15	40	4.7		16	146253	–
		50	4.7		16	146265	146382
	20	40	8.1		16	146277	–
		50	8.1		16	146289	146386
	25	63	13.0		16	146305	146394
		32	63		19.5	16	146318
	40	80	31.0		16	146333	146410
		100	45.0		16	146351	146418
	65	125	73.0		16 (15*)	152752	156480
		125	110.0		14 (12.5*)	152770	156488
	100	125	165.0		9	152806	156496
		175	155.0		14 (10*)	152824	–

* acc. to the Pressure Equipment Directive 2014/68/EU for compressible fluids in Group 1 (hazardous gases and vapors in accordance with Article 4, paragraph (1), c), i), first dash)

Further versions on request



Port connections
Flange acc. to ANSI, JIS
Clamp



Approvals
GL, EC Gas Appliances Directive (previously DVGW), SIL



Control function
I (double-acting actuator)

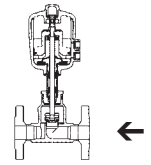

Mediums temperature
Valves for mediums temperature up to +200 °C or down to -40 °C

Ordering chart for valves with flow direction below the seat (other versions on request), *cont.*

Valves with stainless steel body and threaded port connection, flow below seat

Control function	Orifice [mm]	Threaded port connection	Actuator size Ø [mm]	K _v value water [m ³ /h]	Minimum pilot pressure [bar]	Operating pressure up to +180 °C [bar]	Article no. PA actuator	Article no. PPS actuator
A Pneumatically operated on / off valve, normally closed by spring force, flow direction below seat	10	G 3/8	40	4.7	4.0	15	146228	146363
			50	4.7	3.9	16	146238	146371
	15	G 1/2	40	4.7	4.0	15	146248	-
			50	4.7	3.9	16	146260	146379
	20	G 3/4	40	8.1	4.0	6.5	146272	-
			50	8.1	3.9	11	146284	-
			63	8.1	4.5	16	146296	146391
	25	G 1	63	13.0	4.5	11	146300	-
			80	13.0	5.0	16	146311	146399
	32	G 1 1/4	63	19.5	4.5	6	146315	-
			80	19.5	5.0	14	146323	146407
	40	G 1 1/2	80	31.0	5.0	9	146328	-
			125	31.0	3.2	16	146340	146415
	50	G 2	100	45.0	4.4	7.2	146346	-
125			45.0	3.2	10	146358	146423	
175			65.0	5.6	12	152745	156477	
65	G 2 1/2	125	65.0	4.5	16 (15*)	152763	-	
		150	65.0	4.5	16 (15*)	152763	-	
		175	65.0	4.5	16 (15*)	152763	-	
B Pneumatically operated on / off valve, normally open by spring force, flow direction below seat	10	G 3/8	40	4.7	see charts page 3	16	146233	146367
			50	4.7		16	146243	146375
	15	G 1/2	40	4.7		16	146254	-
			50	4.7		16	146266	146383
	20	G 3/4	40	8.1		16	146278	-
			50	8.1		16	146290	146387
	25	G 1	63	13.0		16	146306	146395
	32	G 1 1/4	63	19.5		16	146319	146403
	40	G 1 1/2	80	31.0		16	146334	146411
	50	G 2	100	45.0		16	146352	146419
	65	G 2 1/2	125	65.0		16 (15*)	152754	156481
			150	65.0		16 (15*)	152754	156481
			175	65.0		16 (15*)	152754	156481

* acc. to the Pressure Equipment Directive 2014/68/EU for compressible fluids in Group 1 (hazardous gases and vapors in accordance with Article 4, paragraph (1), c), i), first dash)

Further versions on request

Port connections
 Threaded port NPT, Rc
 Clamp

Control function
 I (double-acting actuator)

Approvals
 GL, EC Gas Appliances Directive (previously DVGW), SIL

Mediums temperature
 Valves for mediums temperature up to +200 °C or down to -40 °C

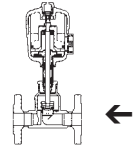
Ordering chart for valves with flow direction below the seat (other versions on request), *cont.*

Valves with stainless steel body and weld end according to EN ISO 1127/ISO 4200, flow below seat

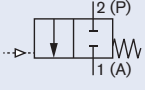
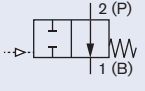
Control function	Orifice [mm]	Weld end EN ISO 1127/ISO 4200 external Ø x Ws [mm]	Actuator size Ø [mm]	K _v value water [m ³ /h]	Minimum pilot pressure [bar]	Operating pressure up to +180 °C [bar]	Article no. PA actuator	Article no. PPS actuator
A  Pneumatically operated on / off valve, normally closed by spring force, flow direction below seat	10	17.2 × 1.6	40	4.7	4.0	15	146229	146364
			50	4.7	3.9	16	146239	146372
	15	21.3 × 1.6	40	4.7	4.0	15	146249	–
			50	4.7	3.9	16	146261	146380
			63	8.1	3.9	11	146273	–
	20	26.9 × 1.6	40	8.1	4.0	6.5	146273	–
			50	8.1	3.9	11	146285	–
			63	8.1	4.5	16	146297	146392
	25	33.7 × 2.0	63	13.0	4.5	11	146301	–
			80	13.0	5.0	16	146312	146400
	32	42.4 × 2.0	63	19.5	4.5	6	146316	–
			80	19.5	5.0	14	146324	146408
	40	48.3 × 2.0	80	31.0	5.0	9	146329	–
			125	31.0	3.2	16	146341	146416
			125	45.0	4.4	7.2	146347	–
	50	60.3 × 2.0	100	45.0	3.2	10	146359	146424
			125	45.0	3.2	10	146359	146424
	65	76.1 × 2.3	125	73.0	5.6	12	152748	156478
175			73.0	4.5	16 (15*)	152766	–	
80	88.9 × 2.3	125	110.0	5.6	7.5	155542	156486	
		175	110.0	4.5	10	152784	–	
		225	110.0	3.3	16 (12.5*)	152802	–	
100	114.3 × 2.6	125	165.0	5.6	5	155551	156494	
		175	155.0	4.5	7.0	152820	–	
		225	155.0	4.8	16 (10*)	152838	–	
B  Pneumatically operated on / off valve, normally open by spring force, flow direction below seat	10	17.2 × 1.6	40	4.7	see charts page 3	16	146234	146368
			50	4.7		16	146244	146376
	15	21.3 × 1.6	40	4.7	16	146255	–	
			50	4.7	16	146267	146384	
	20	26.9 × 1.6	40	8.1	16	146279	–	
			50	8.1	16	146291	146388	
	25	33.7 × 2.0	63	13.0	16	146307	146396	
	32	42.4 × 2.0	63	19.5	16	146320	146404	
	40	48.3 × 2.0	80	31.0	16	146335	146412	
	50	60.3 × 2.0	100	45.0	16	146353	146420	
	65	76.1 × 2.3	125	73.0	16 (15*)	152757	156482	
	80	88.9 × 2.3	125	110.0	14 (12.5*)	152775	156490	
	100	114.3 × 2.6	125	165.0	9	152811	156498	
			175	155.0	14 (10*)	152829	–	

* acc. to the Pressure Equipment Directive 2014/68/EU for compressible fluids in Group 1 (hazardous gases and vapors in accordance with Article 4, paragraph (1), c), i), first dash)

i Further versions on request

Port connections
 Weld end O.D.
 Clamp

Control function
 I (double-acting actuator)

Approvals
 GL, EC Gas Appliances Directive (previously DVGW), SIL

Mediums temperature
 Valves for mediums temperature up to +200 °C or down to -40 °C

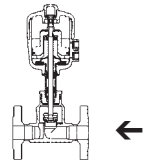
Ordering chart for valves with flow direction below the seat (other versions on request), *cont.*

Valves with stainless steel body and weld end according to DIN 11850 Series 2, flow below seat

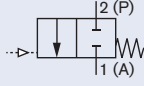
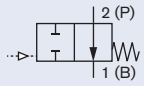
Control function	Orifice [mm]	Weld end DIN 11850 S2 external Ø x Ws [mm]	Actuator size Ø [mm]	K _v value water [m ³ /h]	Minimum pilot pressure [bar]	Operating pressure up to + 180 °C [bar]	Article no. PA actuator	Article no. PPS actuator
A  Pneumatically operated on / off valve, normally closed by spring force, flow direction below seat	10	13 × 1.5	40	4.7	4.0	15	146230	146365
			50	4.7	3.9	16	146240	146373
	15	19 × 1.5	40	4.7	4.0	15	146250	–
			50	4.7	3.9	16	146262	146381
	20	23 × 1.5	40	8.1	4.0	6.5	146274	–
			50	8.1	3.9	11	146286	–
			63	8.1	4.5	16	146298	146393
	25	29 × 1.5	63	13.0	4.5	11	146302	–
			80	13.0	5.0	16	146313	146401
	32	35 × 1.5	63	19.5	4.5	6	146317	–
			80	19.5	5.0	14	146325	146409
	40	41 × 1.5	80	31.0	5.0	9	146330	–
			125	31.0	3.2	16	146342	146417
	50	53 × 1.5	100	45.0	4.4	7.2	146348	–
			125	45.0	3.2	10	146360	146425
	65	70.0 × 2.0	125	73.0	5.6	12	152749	156479
			175	73.0	4.5	16 (15*)	152767	–
	80	85.0 × 2.0	125	110.0	5.6	7.5	155543	156487
175			110.0	4.5	10	152785	–	
225			110.0	3.3	16 (12.5*)	152803	–	
100	104.0 × 2.0	125	165.0	5.6	5	155552	156495	
		175	155.0	4.5	7.0	152821	–	
		225	155.0	4.8	16 (10*)	152839	–	
B  Pneumatically operated on / off valve, normally open by spring force, flow direction below seat	10	13 × 1.5	40	4.7	see charts page 3	16	146235	146369
			50	4.7		16	146245	146377
	15	19 × 1.5	40	4.7		16	146256	–
			50	4.7		16	146268	146385
	20	23 × 1.5	40	8.1		16	146280	–
			50	8.1		16	146292	146389
	25	29 × 1.5	63	13.0		16	146308	146397
	32	35 × 1.5	63	19.5		16	146321	146405
	40	41 × 1.5	80	31.0		16	146336	146413
	50	53 × 1.5	100	45.0		16	146354	146421
	65	70.0 × 2.0	125	73.0		16 (15*)	152758	156483
	80	85.0 × 2.0	125	110.0		14 (12.5*)	152776	156491
	100	104.0 × 2.0	125	165.0		9	152812	156499
			175	155.0		14 (10*)	152830	–

* acc. to the Pressure Equipment Directive 2014/68/EU for compressible fluids in Group 1 (hazardous gases and vapors in accordance with Article 4, paragraph (1), c), i), first dash)

i Further versions on request

Port connections
 Weld end O.D.
 Clamp

Control function
 I (double-acting actuator)

Approvals
 GL, EC Gas Appliances Directive (previously DVGW), SIL

Mediums temperature
 Valves for mediums temperature up to +200 °C or down to -40 °C

Technical data for valves with flow direction above the seat

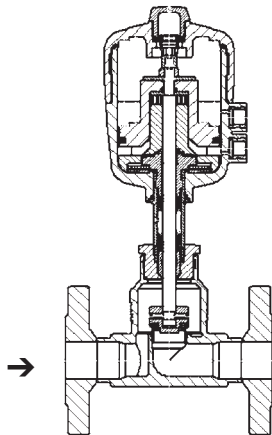

Flow direction above seat

Type 2012 with flange connection

Technical data	Flow direction above the seat
Medium	Gaseous medium and steam
Other technical data	Please see technical data for flow direction below seat

Orifice [mm]	Actuator size [mm]	K _v value water [m ³ /h]	Operating pressure up to +180 °C [bar]	Weight with flange [kg]	Threaded port and weld end [kg]
10	40	3.0	16	2.3	0.8
	50	3.0	16	2.4	0.9
15	40	4.7	16	2.3	0.8
	50	4.7	16	2.4	0.9
20	40	8.1	16	3.1	0.9
	50	8.1	16	3.3	1.1
25	50	13.0	16	4.0	1.4
32	63	19.5	16	6.6	2.9
40	80	31.0	16	8.4	4.2
50	80	45.0	16	11.4	5.6
65	125	73.0	10	20.2	12.9
80	125	110.0	10	24.5	16.1
100	125	165.0	6	32.9	20.6

Pressure charts

DN10 ... 20

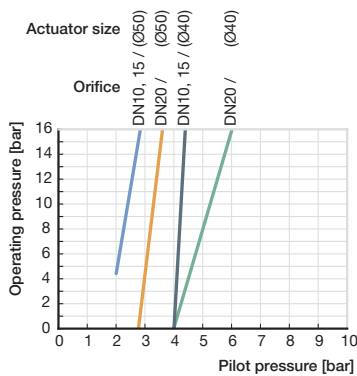

DN25 ... 50

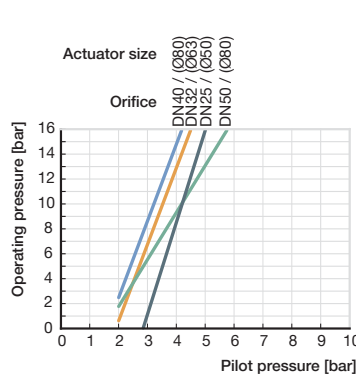

DN65 ... 100

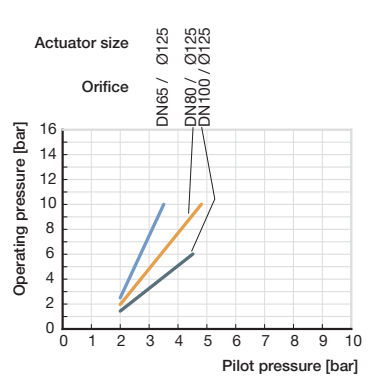

Ordering chart valves with flow direction above the seat (other versions on request)

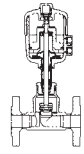

Valves with stainless steel body and flange connection according to DIN EN 1092-1, flow above seat

Control function	Orifice [mm]	Connection	Actuator size Ø [mm]	K _v value water [m ³ /h]	Minimum pilot pressure [bar]	Operating pressure up to + 180 °C [bar]	Article no. PA actuator	Article no. PPS actuator
<p>Pneumatically operated on / off valve, normally closed by spring force, flow direction above seat</p>	10	Flange	40	4.7	see charts page 8	16	146427	–
			50	4.7		16	146432	146492
	15	Flange	40	4.7	16	146437	–	
			50	4.7	16	146443	146496	
	20	Flange	40	8.1	16	146448	–	
			50	8.1	16	146454	146500	
	25	Flange	50	13.0	16	146460	146504	
	32	Flange	63	19.5	16	146465	146508	
	40	Flange	80	31.0	16	146476	146512	
	50	Flange	80	45.0	16	146487	146516	
	65	Flange	125	73.0	10	152842	–	
	80	Flange	125	110.0	10	152851	–	
	100	Flange	125	165.0	6	152860	–	

Valves with stainless steel body and threaded port connection, flow above seat

Control function	Orifice [mm]	Connection	Actuator size Ø [mm]	K _v value water [m ³ /h]	Minimum pilot pressure [bar]	Operating pressure up to + 180 °C [bar]	Article no. PA actuator	Article no. PPS actuator
<p>Pneumatically operated on / off valve, normally closed by spring force, flow direction above seat</p>	10	G ¾	40	4.7	see charts page 8	16	146428	–
			50	4.7		16	146433	146493
	15	G ½	40	4.7	16	146438	–	
			50	4.7	16	146444	146497	
	20	G ¾	40	8.1	16	146449	–	
			50	8.1	16	146455	146501	
	25	G 1	50	13.0	16	146461	146505	
	32	G ¼	63	19.5	16	146466	146509	
	40	G 1 ½	80	31.0	16	146477	146513	
	50	G 2	80	45.0	16	146488	146517	
	65	G 2 ½	125	65.0	10	152844	–	

Attention!

Valves with flow direction above the seat are only conditionally usable for liquid media.

Waterhammer will occur! For flange and threaded port connections pilot pressures, please refer to Charts on page 8.

Further versions on request

**Port connections**

Flange acc. to ANSI, JIS
Threaded port NPT, Rc
Clamp

**Control function**

I (double-acting actuator) and B (spring-return normally-open)

**Approvals**







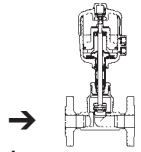



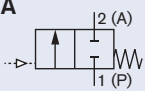







GL, EC Gas Appliances Directive (previously DVGW), SIL

**Mediums temperature**











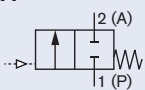







Valves for mediums temperature up to + 200 °C or down to - 40 °C

Ordering chart valves with flow direction above the seat (other versions on request), *cont.*

Valves with stainless steel body and weld end according to EN ISO 1127/ISO 4200, flow above seat

Control function	Orifice [mm]	Weld end external Ø x Ws [mm]	Actuator size Ø [mm]	K _v value water [m ³ /h]	Minimum pilot pressure [bar]	Operating pressure up to +180 °C [bar]	Article no. PA actuator	Article no. PPS actuator
A  Pneumatically operated on / off valve, normally closed by spring force, flow direction above seat	10	17.2 × 1.6	40	4.7	see charts page 8	16	146429 	–
			50	4.7		16	146434 	146494 
	15	21.3 × 1.6	40	4.7	16	146439 	–	
				50		4.7	16	146445 
	20	26.9 × 1.6	40	8.1	16	146450 	–	
				50		8.1	16	146456 
	25	33.7 × 2.0	50	13.0	16	146462 	146506 	
	32	42.4 × 2.0	63	19.5	16	146467 	146510 	
	40	48.3 × 2.0	80	31.0	16	146478 	146514 	
	50	60.3 × 2.0	80	45.0	16	146489 	146518 	
	65	76.1 × 2.3	125	73.0	10	152847 	–	
	80	88.9 × 2.3	125	110.0	10	152856 	–	
100	114.3 × 2.6	125	165.0	6	152865 	–		

Valves with stainless steel body and weld end according to DIN 11850 Series 2, flow above seat

Control function	Orifice [mm]	Weld end external Ø x Ws [mm]	Actuator size Ø [mm]	K _v value water [m ³ /h]	Minimum pilot pressure [bar]	Operating pressure up to +180 °C [bar]	Article no. PA actuator	Article no. PPS actuator
A  Pneumatically operated on / off valve, normally closed by spring force, flow direction above seat	10	13 × 1.5	40	4.7	see charts page 8	16	146430 	–
			50	4.7		16	146435 	146495 
	15	19 × 1.5	40	4.7	16	146440 	–	
				50		4.7	16	146446 
	20	23 × 1.5	40	8.1	16	146451 	–	
				50		8.1	16	146457 
	25	29 × 1.5	50	13.0	16	146463 	146507 	
	32	35 × 1.5	63	19.5	16	146468 	146511 	
	40	41 × 1.5	80	31.0	16	146479 	146515 	
	50	53 × 1.5	80	45.0	16	146490 	146519 	
	65	70.0 × 2.0	125	73.0	10	152848 	–	
	80	85.0 × 2.0	125	110.0	10	152857 	–	
100	104.0 × 2.0	125	165.0	6	152866 	–		

Attention!

Valves with flow direction above the seat are only conditionally usable for liquid media. Waterhammer will occur! For weld ends according to EN ISO 1127/ISO 4200 and DIN 11850 Series 2 pilot pressures, please refer to Charts page 8.

i Further versions on request

Port connections
Weld end, O.D.
Clamp



Control function
I (double-acting actuator) and B (spring-return normally-open)



Approvals
GL, EC Gas Appliances Directive (previously DVGW), SIL



Mediums temperature
Valves for mediums temperature up to +200 °C or down to -40 °C

Ordering chart for accessories

3/2 way pilot valves with banjo bolts

Seal material valve FKM, seal material banjo bolt NBR

Valve for actuator size [Ø mm]	Type	Pressure inlet P (valve body)	Service port A (banjo bolt)	Orifice [mm]	Q _{Nn} value air [l/min]	Pressure range [bar]	Electrical coil connection Ind. Std.	Power consumption [W]	Article no. Voltage/frequency [V/Hz]	
									024/DC	230/50
40	6012P	Tube fitting Ø6 mm	G 1/8	1.2	48	0 ... 10	Form B	4	552287	552290
40	6012P	G 1/8	G 1/8	1.2	48	0 ... 10	Form B	4	552299	552302
40	6012P	G 1/4	G 1/8	1.2	48	0 ... 10	Form B	4	552295	552298
50 ... 63	6012P	Tube fitting Ø6 mm	G 1/4	1.2	48	0 ... 10	Form B	4	552283	552286
50 ... 125	6014P	G 1/4	G 1/4	2	120	0 ... 10	Form A	8	424103	424107
175 ... 225	6014P	G 1/8	G 1/4	2.5	174	0 ... 6	Form A	8	786014	786015
175 ... 225	0331P	G 1/4	G 1/4	3	194	0 ... 10	Form A	8	-	041233

Cable plug Type 2507, Form B or Type 2508, Form A

	Article no.
Type 2507, Form B Industrial standard, 0 ... 250 V without circuitry (Type 6012 P)	423845
Type 2508, Form A acc. DIN EN 175 301-803, 0 ... 250 V without circuitry (Type 6014 P, Type 0331P)	008376

For further accessories see Type 1062, or the accessories datasheet Type 2XXX for the full options programme.

Note: For design reasons, some of the accessories cannot be supplied for actuator size Ø 40, 175 and 225 mm. Please request the accessories datasheet Type 2XXX.

Dimensions [mm]

Threaded and weld end
DN10 ... 50

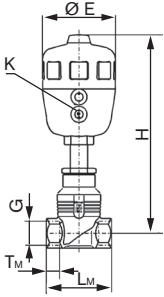
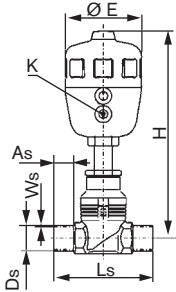
<p>With threaded port connection</p> 					<p>With weld end acc. to EN ISO 1127/ISO 4200 or DIN 11850 Series 2</p> 										
All bodies					Threaded port body			Weld end bodies EN ISO 1127/ISO 4200				Weld end bodies DIN11850 Series 2			
DN	Actuator size Ø	E Ø	H	K	G	LM	TM	As	Ds	Ls	Ws	As	Ds	Ls	Ws
10	40	53	185	G 1/8	G 3/8	65	12	20	17.2	90	1.6	20	13	90	1.5
	50	64	211	G 1/4											
15	40	53	185	G 1/8	G 1/2	65	14	20	21.3	90	1.6	20	19	90	1.5
	50	64	211	G 1/4											
20	40	53	187	G 1/8	G 3/4	75	16	20	26.9	100	1.6	20	23	100	1.5
	50	64	213	G 1/4											
	63	80	247												
25	50	64	220	G 1/4	G 1	90	18	26	33.7	130	2.0	26	29	130	1.5
	63	80	251												
	80	101	273												
32	63	80	271	G 1/4	G 1 1/4	110	20	26	42.4	140	2.0	26	35	140	1.5
	80	101	294												
40	80	101	299	G 1/4	G 1 1/2	120	22	26	48.3	150	2.0	26	41	150	1.5
	100	127	366												
	125	157	397												
50	80	101	309	G 1/4	G 2	150	24	26	60.3	175	2.0	26	53	175	1.5
	100	127	370												
	125	153	402												

DN65 ... 100

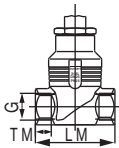
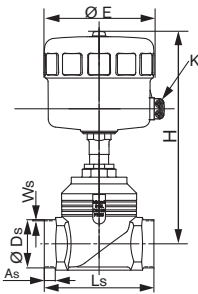
<p>With threaded port connection</p> 					<p>With weld end acc. to EN ISO 1127/ISO 4200 or DIN 11850 Series 2</p> 										
All bodies					Threaded port body			Weld end bodies EN ISO 1127/ISO 4200				Weld end bodies DIN11850 Series 2			
DN	Actuator size Ø	E Ø	H	K	G	LM	TM	As	Ds	Ls	Ws	As	Ds	Ls	Ws
65	125	157	430	G 1/4	G 2 1/2	185	26	26	76.1	210	2.3	26	70	210	2
	175	211	491												
80	125	157	440	G 1/4	-	-	-	26	88.9	230	2.3	26	85	230	2
	175	211	498												
	225	261	494												
100	125	157	450	G 1/4	-	-	-	26	114.3	260	2.6	26	104	260	2
	175	211	508												
	225	261	504												

Dimensions [mm], *continued*

Flange connection

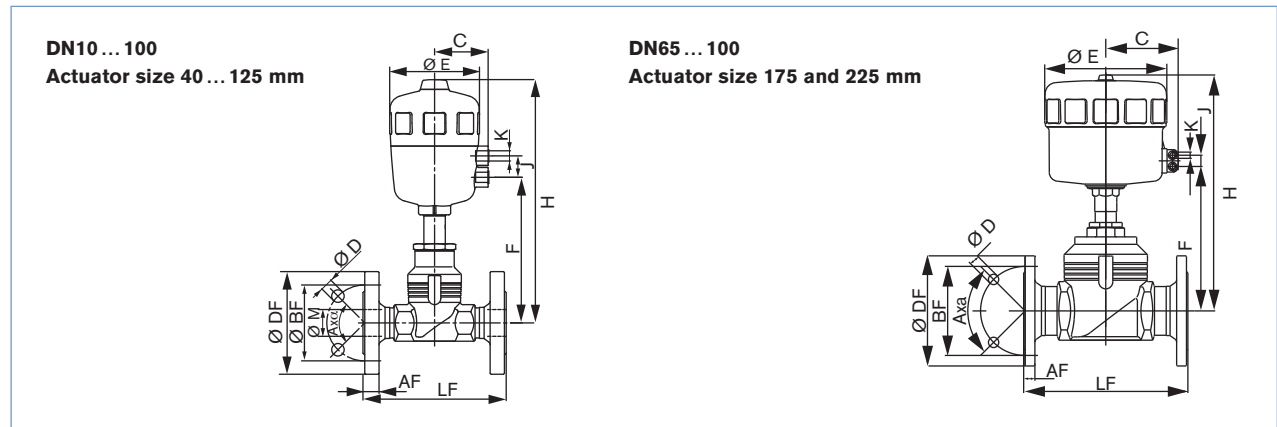

All bodies								DIN flange						JIS flange							
DN	Actuator	C	ØE	F	H	K	J	ØDF	LF	ØBF	AF	ØD	AxD	ØM	ØDF	LF	ØBF	AF	ØD	AxD	ØM
10	40	33	53	116	185	G 1/8	16.5	90	130	60	16	14	4 x 90°	14	-	-	-	-	-	-	-
	50	44	64	131	211	G 1/4	24	90	130	60	16	14	4 x 90°	14	-	-	-	-	-	-	-
15	40	33	53	116	185	G 1/8	16.5	95	130	65	16	14	4 x 90°	18	95	108	70	12	15	4 x 90°	18
	50	44	64	131	211	G 1/4	24	95	130	65	16	14	4 x 90°	18	95	108	70	12	15	4 x 90°	18
20	40	33	53	118	187	G 1/8	16.5	105	150	75	18	14	4 x 90°	24	100	117	75	14	15	4 x 90°	24
	50	44	64	135	213	G 1/4	24	105	150	75	18	14	4 x 90°	24	100	117	75	14	15	4 x 90°	24
	63	52	80	155	247	G 1/4	24	105	150	75	18	14	4 x 90°	24	100	117	75	14	15	4 x 90°	24
25	50	44	64	140	220	G 1/4	24	115	160	85	18	14	4 x 90°	30	125	127	90	14	19	4 x 90°	30
	63	52	80	159	251	G 1/4	24	115	160	85	18	14	4 x 90°	30	125	127	90	14	19	4 x 90°	30
	80	60	101	164	273	G 1/4	24	115	160	85	18	14	4 x 90°	30	125	127	90	14	19	4 x 90°	30
32	63	52	80	179	271	G 1/4	24	140	180	100	18	18	4 x 90°	38	135	140	100	16	19	4 x 90°	38
	80	60	101	184	294	G 1/4	24	140	180	100	18	18	4 x 90°	38	135	140	100	16	19	4 x 90°	38
40	63	52	80	184	276	G 1/4	24	150	200	110	18	18	4 x 90°	44	140	165	105	16	19	4 x 90°	44
	80	60	101	189	299	G 1/4	24	150	200	110	18	18	4 x 90°	44	140	165	105	16	19	4 x 90°	44
	100	73	127	214	366	G 1/4	30	150	200	110	18	18	4 x 90°	44	140	165	105	16	19	4 x 90°	44
	125	86	157	220	397	G 1/4	30	150	200	110	18	18	4 x 90°	44	140	165	105	16	19	4 x 90°	44
50	63	52	80	195	287	G 1/4	24	165	230	125	20	18	4 x 90°	56	155	203	120	16	19	4 x 90°	56
	80	60	101	199	309	G 1/4	24	165	230	125	20	18	4 x 90°	56	155	203	120	16	19	4 x 90°	56
	100	73	127	218	370	G 1/4	30	165	230	125	20	18	4 x 90°	56	155	203	120	16	19	4 x 90°	56
	125	86	157	225	402	G 1/4	30	165	230	125	20	18	4 x 90°	56	155	203	120	16	19	4 x 90°	56
65	125	86	157	254	430	G 1/4	30	185	290	145	22	18	8 x 45°	66	175	216	140	18	19	4 x 90°	72
	175	130	211	289	491	G 1/4	24	185	290	145	22	18	8 x 45°	66	175	216	140	18	19	4 x 90°	72
80	125	86	157	264	440	G 1/4	30	200	310	160	24	18	8 x 45°	81	185	241	150	18	19	8 x 45°	84
	175	130	211	296	498	G 1/4	24	200	310	160	24	18	8 x 45°	81	185	241	150	18	19	8 x 45°	84
	225	155	261	299	494	G 1/4	24	200	310	160	24	18	8 x 45°	81	185	241	150	18	19	8 x 45°	84
100	125	86	157	274	450	G 1/4	30	235	350	190	24	22	8 x 45°	100	210	292	175	18	19	8 x 45°	109
	175	130	211	306	508	G 1/4	24	235	350	190	24	22	8 x 45°	100	210	292	175	18	19	8 x 45°	109
	225	155	261	309	504	G 1/4	24	235	350	190	24	22	8 x 45°	100	210	292	175	18	19	8 x 45°	109

DTS 1000010970 EN Version: AB Status: RL (released | freigegeben | valide) printed: 11.02.2020

Dimensions [mm], *continued*

Flange connection

All bodies								ANSI flange						
DN	Actuator	C	ØE	F	H	K	J	ØDF	LF	ØBF	AF	ØD	AxD	ØM
½"	40	33	53	116	185	G ½	16.5	89	184	60.5	11.2	15.7	4 × 90°	16
	50	44	64	131	211	G ¼	24	89	184	60.5	11.2	15.7	4 × 90°	16
¾"	40	33	53	118	187	G ½	16.5	99	184	69.9	12.7	15.7	4 × 90°	21
	50	44	64	135	213	G ¼	24	99	184	69.9	12.7	15.7	4 × 90°	21
	63	52	80	155	247	G ¼	24	99	184	69.9	12.7	15.7	4 × 90°	21
1"	50	44	64	140	220	G ¼	24	108	184	79.2	14.2	15.7	4 × 90°	27
	63	52	80	159	251	G ¼	24	108	184	79.2	14.2	15.7	4 × 90°	27
	80	60	101	164	273	G ¼	24	108	184	79.2	14.2	15.7	4 × 90°	27
1 ½"	63	52	80	184	276	G ¼	24	127	222	98.6	17.5	15.7	4 × 90°	41
	80	60	101	189	299	G ¼	24	127	222	98.6	17.5	15.7	4 × 90°	41
	100	73	127	214	366	G ¼	30	127	222	98.6	17.5	15.7	4 × 90°	41
	125	86	157	220	397	G ¼	30	127	222	98.6	17.5	15.7	4 × 90°	41
2"	63	52	80	195	287	G ¼	24	152	254	120.7	19.1	19.1	4 × 90°	53
	80	60	101	199	309	G ¼	24	152	254	120.7	19.1	19.1	4 × 90°	53
	100	73	127	218	370	G ¼	30	152	254	120.7	19.1	19.1	4 × 90°	53
	125	86	157	225	402	G ¼	30	152	254	120.7	19.1	19.1	4 × 90°	53
2 ½"	125	86	157	254	430	G ¼	30	178	276	139.7	22.3	19.1	4 × 90°	63
	175	130	211	289	491	G ¼	24	178	276	139.7	22.3	19.1	4 × 90°	63
3"	125	86	157	264	440	G ¼	30	190	298	152.4	23.9	19.1	4 × 90°	78
	175	130	211	296	498	G ¼	24	190	298	152.4	23.9	19.1	4 × 90°	78
	225	155	261	299	494	G ¼	24	190	298	152.4	23.9	19.1	4 × 90°	78
4"	125	86	157	274	450	G ¼	30	229	352	190.5	23.9	19.1	8 × 45°	102
	175	130	211	306	508	G ¼	24	229	352	190.5	23.9	19.1	8 × 45°	102
	225	155	261	309	504	G ¼	24	229	352	190.5	23.9	19.1	8 × 45°	102

Ordering information for valve system On/Off CLASSIC Type 8801-YA

An **globe valve Type 2012** can be combined with the **feedback Type 8697** to form a **valve system On/Off CLASSIC**.

The valve system On/Off CLASSIC is composed of: [More info.](#)

- a feedback **Type 8697** (see separate datasheet)
- a globe valve **Type 2012** (see ordering chart p. 4)

For the configuration of further valve systems please use the "Request for quotation" on p. 17 [go to page](#)

You order two components and receive a complete assembled and certified valve.



Electrical position feedback

[More info.](#)



Type 8697

Actuator size 40 ... 225

The position feedback Type 8697 is designed for integrated mounting on CLASSIC series 20XX process valves suiting the requirements of hygienic process environment. Mechanical or inductive limit switches register the position of the valve.

Features

- Compact design
- LED position indicator
- Mechanical or inductive limit switches for end position registering
- Easy to clean chemically resistant housing featuring IP65 / IP67, 4X Rating
- Optional intrinsically safe version acc. to ATEX

Benefits

- Easy and quick installation
- High level of signal reliability thanks to self adjusting limit switches
- Signal safety through the automatic adjustment of the limit switches
- Minimised space requirement in the plant piping for more flexibility in plant design

Click on the orange box „More info“... you will come to our website for the resp. product where you can download the data sheet.

Dimensions for valve system On/Off Classic Type 8801-GA [mm]

Dimensions valve system On/Off Classic Type 8801-GA with electrical position feedback Type 8697

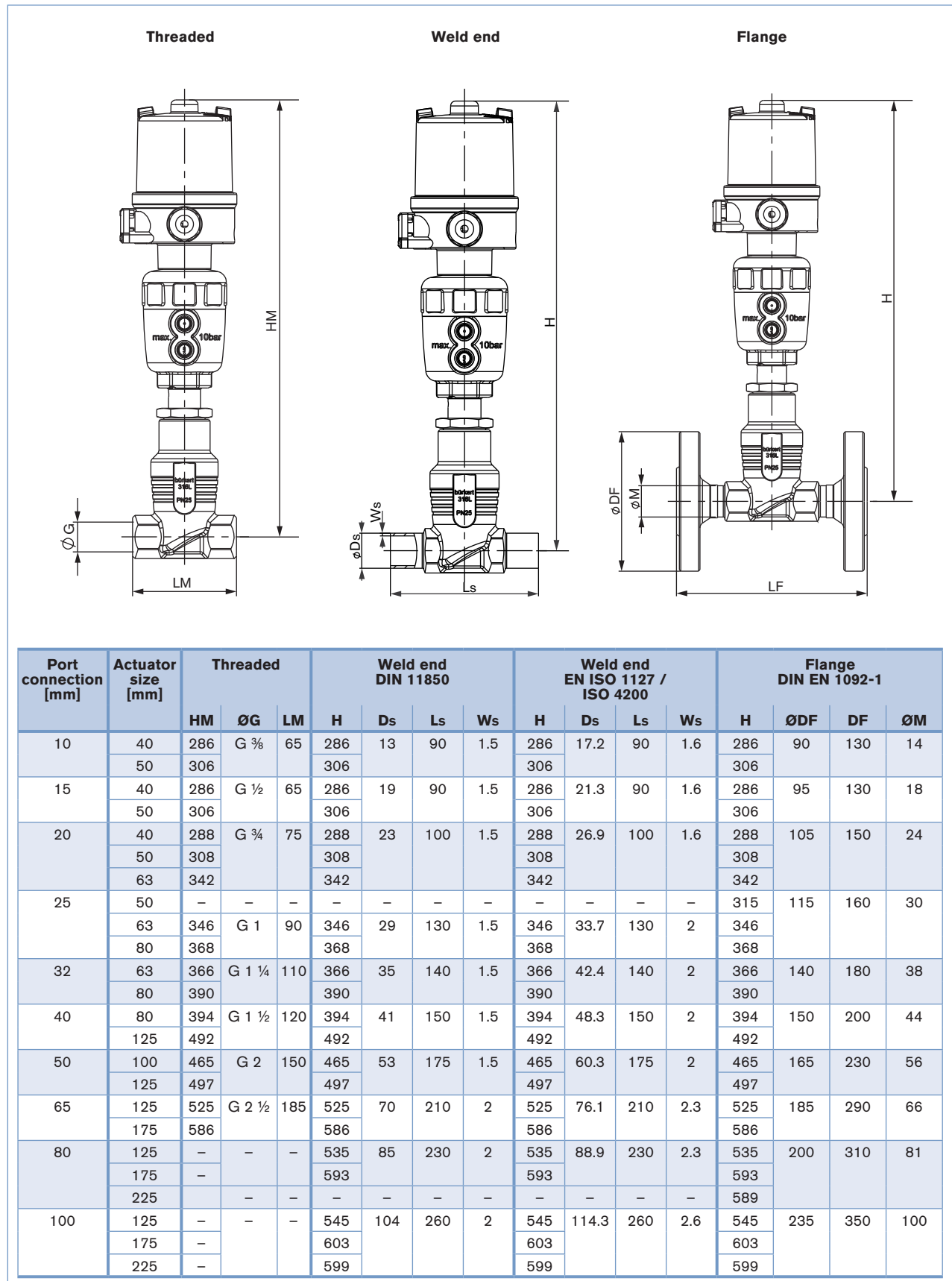

Note

You can fill out the fields directly in the PDF file before printing out the form.

Valve system On/Off Classic Type 8801-GA – request for quotation

Please fill out and send to your nearest Bürkert facility* with your inquiry or order

Company	Contact person
Customer no.	Department
Address	Tel./Fax
Postcode/town	E-Mail

= mandatory fields to fill out

Quantity

Required delivery date

Operating data

Pipeline	DN	<input type="text"/>	PN	<input type="text"/>
Pipe material	<input type="text"/>			
Process medium	<input type="text"/>			
Type of medium	<input type="checkbox"/> Liquid	<input type="checkbox"/> Steam	<input type="checkbox"/> Gas	
	standard	unit		
Flow rate (Q, Q _N , W) ¹⁾	<input type="text"/>	<input type="text"/>		
Temperature at valve inlet	<input type="text"/>	<input type="text"/>		
Absolute pressure at valve inlet	<input type="text"/>	<input type="text"/>		

¹⁾ standard unit: Liquid Q = m³/h; Steam W = kg/h; Gas Q_N = Nm³/h

Valve features

Actuator material	<input type="checkbox"/> PA	<input type="checkbox"/> PPS
Body material	<input type="checkbox"/> Stainless steel	<input type="checkbox"/> Gunmetal
Seat sealing material	<input type="checkbox"/> PTFE <input type="checkbox"/> NBR	<input type="checkbox"/> Other <input type="text"/>
Nominal pressure	PN <input type="text"/>	
Nominal size	DN <input type="text"/>	
Type of connection	<input type="checkbox"/> Welded <input type="checkbox"/> Internal thread <input type="checkbox"/> Clamp	
Standard connection	<input type="checkbox"/> ISO <input type="checkbox"/> DIN <input type="checkbox"/> ANSI <input type="checkbox"/> JIS <input type="checkbox"/> Other <input type="text"/>	
Function	<input type="checkbox"/> NC ²⁾ <input type="checkbox"/> NO ²⁾ <input type="checkbox"/> Double-acting	
Pilot pressure	<input type="text"/> min.	<input type="text"/> max.

²⁾ NC: normally closed by spring action; NO: normally open by spring action

Automation unit features

Click on the orange box „More info“... you will come to our website for the resp. product where you can download the data sheet.

Electrical position feedback

Type 8697
For actuator size 40 ... 225



More info.

- LED position indicator
- Mechanical or inductive limit switches for end position registering
- Housing with IP65/IP67, 4X rating protection
- Optional intrinsically safe version acc. to ATEX / IECEx

<p>Position feedback switches</p> <p><input type="checkbox"/> Micro switch 24 V DC</p> <p><input type="checkbox"/> Micro switch 50 ... 225 V DC/AC</p> <p><input type="checkbox"/> Inductive switch 3-wire PNP</p> <p><input type="checkbox"/> Inductive switch 2-wire NAMUR</p> <p><input type="checkbox"/> Inductive switch 2-wire 24 V DC</p>	<p>Electrical connection</p> <p><input type="checkbox"/> Cable gland</p> <p><input type="checkbox"/> M12 connector (applicable only with inductive switch 3-wire PNP)</p>
<p>Number of Position feedback switches</p> <p><input type="checkbox"/> 2x</p>	<p>Approval</p> <p><input type="checkbox"/> ATEX cat. 3GD, IECEx</p> <p><input type="checkbox"/> ATEX cat. 2DG, IECEx</p> <p><input type="checkbox"/> without</p>

Valve system On/Off Classic Type 8801-GA – request for quotation, *continued*

Valve accessories	
Pilot valve	Stroke limitation
<input type="checkbox"/> Pilot valve	<input type="checkbox"/> Stroke limitation
Power supply <input type="text"/>	<input type="checkbox"/> Min./max. stroke limitation , with visual position indicator
	<input type="checkbox"/> Max. stroke limitation , without visual position indicator
Please specify item no. if known: <input type="text"/>	Please specify item no. if known: <input type="text"/>

Certifications
<input type="checkbox"/> Attestation of compliance with the order EN-ISO 10204 2.1
<input type="checkbox"/> Test report EN-ISO 10204 2.2
<input type="checkbox"/> Certification of Conformity for Raw Material EN-ISO 10204 3.1
<input type="checkbox"/> EN161 (EC Gas Appliances Directive)

Comment / sketch

DTS 1000010970 EN Version: AB Status: RL (released | freigegeben | validé) printed: 11.02.2020

*To find your nearest Bürkert facility, click on the orange box → www.burkert.com