



# Safety Instructions



0,1,2,4,6,7,8,9,11,  
15,22,25,27



Info Hotline **+49 (0) 5041 998 389**

Mon. - Do. 7<sup>00</sup> - 20<sup>00</sup>  
Fr. 7<sup>00</sup> - 17<sup>00</sup>

Paulmann Licht GmbH  
31832 Springe / Germany  
www.paulmann.com

Art.-Nr.:  
**703.50**

(+MA 173)  
PJH 09/12

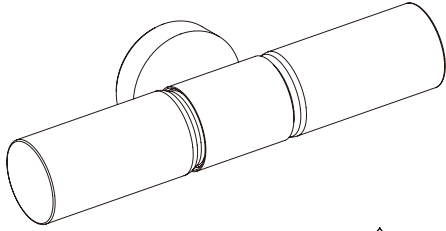

Incl.

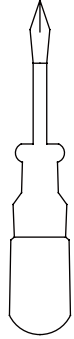
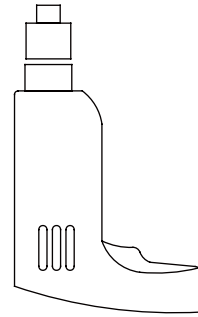
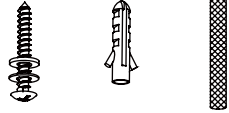

**A**

 Safety Instructions  
Nr. 0,1

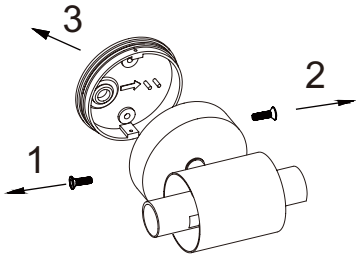

**B**

 Safety Instructions  
Nr. 0,1,2

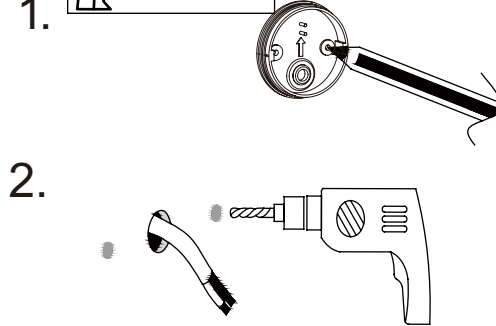

**C**

 Safety Instructions  
Nr. 0,1

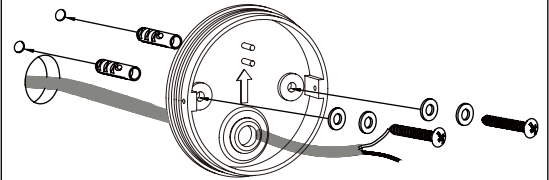

**D**

 Safety Instructions  
Nr. 0,1,4

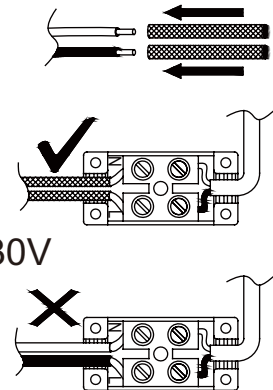
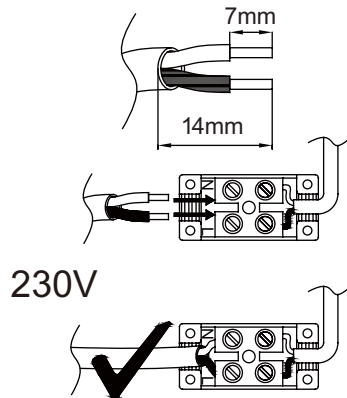
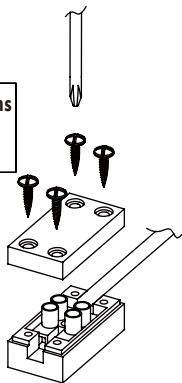

**E**

 Safety Instructions  
Nr. 7,8

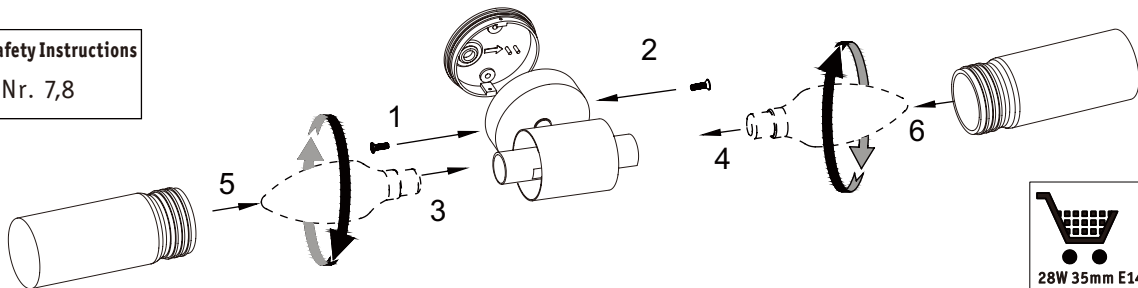

A,B,C,D,E

