

# HSEUreg04801

# DIN Rail

Made in Germany

## 480W Programmable DC Power Supply

### Short Specification:

- Metal housing
- 90% efficiency
- -25°C...+60°C full output power
- Natural convection
- Galvanic insulated
- Continuous short circuit protected
- Overload (OVP) & low voltage protected
- Soft start & auto-recovery
- Hold up time >50ms
- No base load required
- Analogue interface 0-10Vdc/0-20mA/4-20mA(option)
- External shutdown
- Sense control
- Series & parallel operation
- DIN Rail 35mm & wall mount
- Screw terminals AWG20...AWG6
- High reliability, shock & vibration proof
- 24 hours burn in test
- EMI/EMS EN61000-6-2,3, EN55022 class B
- IEC(EN)60950-1 in accordance to cUL60950/16950

**Available outputs: 0...18V, 0...30V, 0...50V, 0...90V, 0...130V, 0...180V, 0...240V**

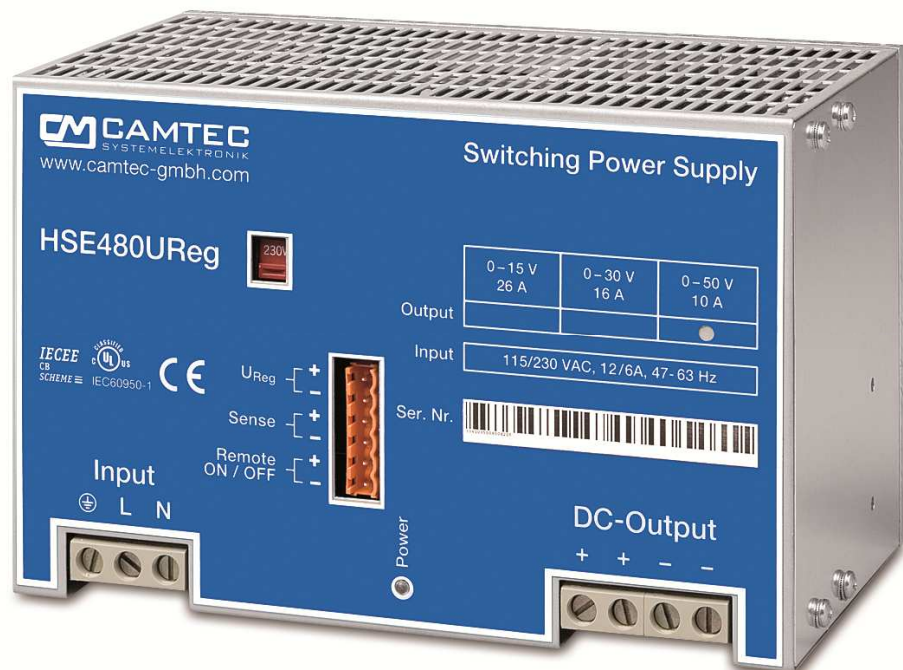

In accordance with IEC60950-1

AC Input	90..132Vac / 184..265Vac , 47...63Hz , 250...375Vdc						
AC Input Rating	115Vac<8.8A 230Vac<4.3A 250Vdc<2.4A 375Vdc<1.6A						
Rated DC Voltage	0...15V	0...30V	0...50V	0...90V	0...130V	0...180V	0..240V
Oversvoltage Protection	18Vdc	35Vdc	59Vdc	105Vdc	150Vdc	210Vdc	280Vdc
Rated DC Current	26A	16A	10A	5.3A	3.7A	2.7A	2.0A
Power Boost -25...+60°C <1min.	28.6A	17.6A	11A	5.8A	4.1A	3.0A	2.2A
Max. DC Current +70°C	19.5A	12A	7.5A	4A	2.8A	2A	1.5A
Ripple Peak 230Vac 20MHz	40mVpp	50mVpp	100mVpp	150mVpp	200mVpp	300mVpp	400mVpp
Sense function	Compensation 2V per lead load, protective electrical separation ≤60Vdc						
Remote Shutdown	protective electrical separation ≤60Vdc						
Analogue Interface	see table, 4-20mA available option, protective electrical separation ≤60Vdc, work.res.=500Ω						
Pmax	480W continuous						
Derating	+60°C...+70°C 2.5%/°C						
Accuracy	< ± 1.5% Interface						
Latency Interface	t.b.d.						
Load regulation	< ± 0.2% 0-100%						
Response Load Change	<1ms 10-100%, 100-10%						
Base Load	None						
Efficiency 230Vac	90% typical						
Short Circuit Protection	Continuous						
Idling-proof	Yes						
Temperature Control	Yes, thermal shutdown with auto recovery (+70°C, metering distance 10mm)						
Hold Up Time	> 50ms 230Vac						
Inrush Current	< 81A (230Vac)						
Softstart	100ms typical						
Cooling	Natural convection						
Ambient Operating Temp.	- 25°C...+70°C						
Ambient Storage Temp.	- 40°C...+85°C						
Environment	Humidity 95% non-condensing @ 25°C, climate class. 3k3, pollution rate II						
EMI	EN55022 class B						
EMS	EN61000-6-2,3						
Safety	cUL60950, EN60950-1, EN60204-1						
Safety class 1(A)	VDE0805, VDE0100						
Isolation Path	> 8mm						
Input / Output	Galvanic insulated						
Meantime By Failure (MTBF)	400000h (IEC61709)						
Dimensions (HxWxD)	130x200x114,5mm						
Weight	2900g						
Screw Terminals (In/Out)	AWG20...AWG6 , 0.5...16mm <sup>2</sup> (76A @ 40°C)						

<b>Interface</b>	
Programme [V]	0...10Vdc
Programme [A]	0...20mA
Programme [A]	4...20mA <sup>1)</sup>
Shutdown	External
Sensing	2V lead load

<sup>1)</sup> option

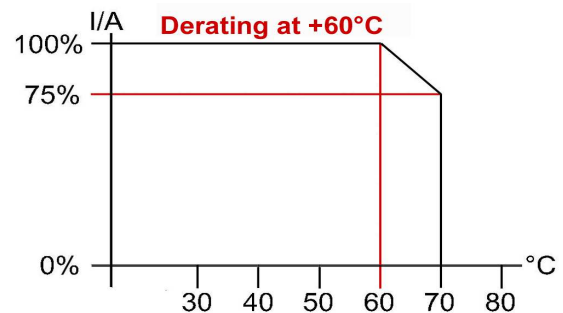
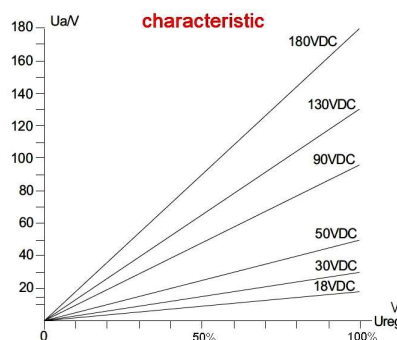

### Ordering Information:

Output	Type (DIN-Rail standard)	Part Number	Option	Part Number
0...18V	HSEUreg04801.18T	304.1051.001CA	Backplate kit (wallmount)	220.1002.001CA
0...30V	HSEUreg04801.30T	304.1051.002CA		
0...50V	HSEUreg04801.50T	304.1051.003CA	ADTW201 DC-repeater	304.1090.001CA
0...90V	HSEUreg04801.90T	304.1051.004CA		
0...130V	HSEUreg04801.130T	304.1051.005CA	4..20mA option	Ad 420 to the type number example: HSEUreg04801.15T420
0...180V	HSEUreg04801.180T	304.1051.006CA		
0...240V	HSEUreg04801.240T	304.1051.007CA	Screw terminal plug	3520037 2pol. LS5,08 (package=10pcs)

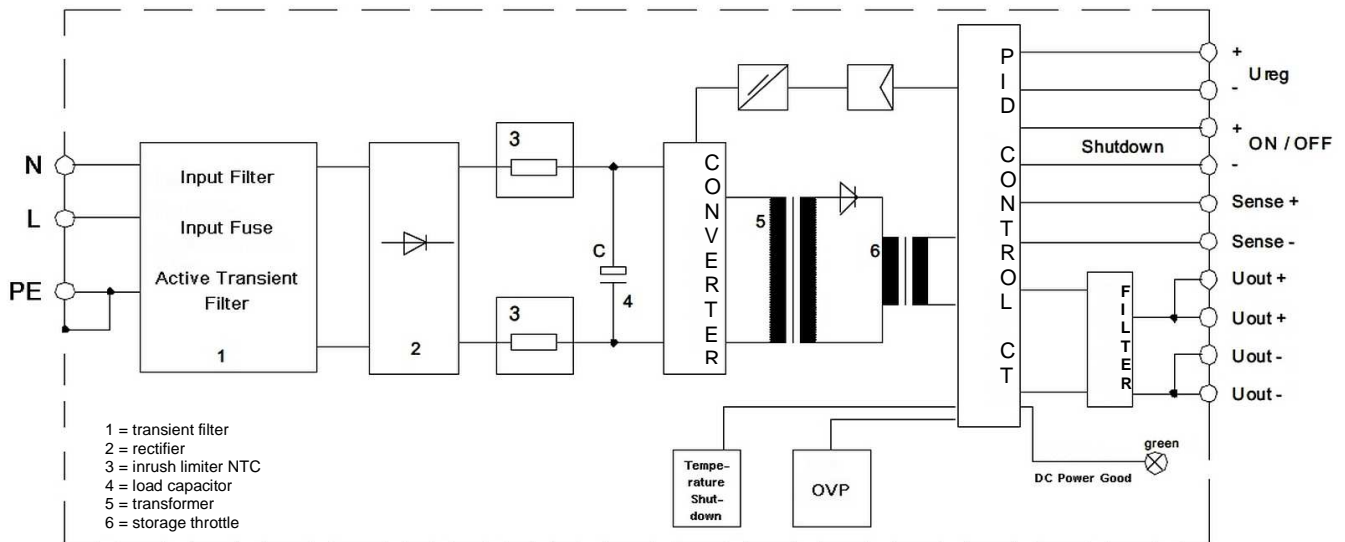

### Technical Description

The HSEUreg-Series is a programmable switch mode power supply. Engineered and manufactured in by CAMTEC in Germany, it is designed for challenging applications like railway, drives, test-stands and machine-building. The HSEUreg provides a low Ripple-Noise, good Load-Regulation and high efficiency >90% (typ. @ 230Vac). High-end long life capacitors guarantee Hold-up-Time and extended lifetime of the power supply. Our HSEUreg-design starts complex loads easily. The internal control manages illegal operating conditions to prevent your system from failures. All HSEUreg power supplies are idling-proof and short circuit protected. Supply units of the same type and output voltage feature parallel or series operation.

The HSEUreg also features active high input transients with suppressor diodes, X2-capacitors and varistors. The design rules set value on extended interference immunity and safety. The PSU is engineered in accordance to EN60950-1 and EMC-compatibility to EN55022 class B.

### Series Connection (fig.1)

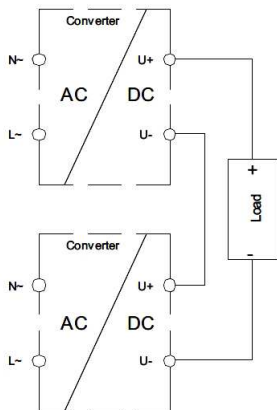

### Parallel Connection (fig.2)

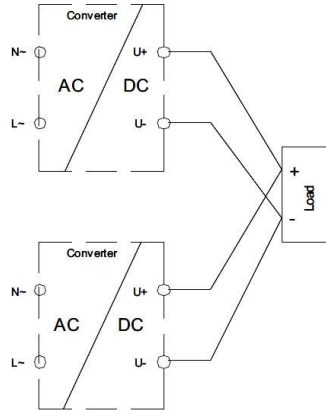

### Series Connection (fig.1)

To increase output voltage equal HSEUreg can be connected in series. The control I/O should be galvanic insulated in the series mode. If not the minus main output is connected to the control I/O. Use our external option Isolating Transformer ADTW201 being validated with the HSEUreg. Be aware of safety norms if your target output voltage exceeds safety voltage.

### Parallel Connection (fig.2)

To increase the output power up to 3 HSEUreg can be parallel connected. Advise using busbars to connect HSEUreg in parallel. Always use identical length and identical cross sections to the busbar.

### ADTW201 Isolating Transformer (option)

The isolating transformer is used to galvanic isolate impressed current. The device is self powered. The input to output ratio is 1:1.

Technical Information ADTW201 external DC-Repeater	
Input (Ie)	0...20mA, 4...20mA (max. 50mA)
Voltage drop (Uw)	Uw > 1.5V (Ie=20mA)
Max. apparent ohmic resistance (Ra)	500R @ Ie=20mA
Input Impedance (R)	R=Ra+Uw/Ie
Barrier Frequency (Fa)	Fa=5kHz (-3dB) with Ra=500R @ Ie=20mA
Output	1:1
Ripple / Noise	>0,5% with 20mA and Ra=500R
Linear Failure	>0,03% / 100R
Transient oscillation current	35uA
Latency	150us 0..20mA, Ra=500R, 10...90%
Isolation Voltage Input/output	500V
Operation Temperature	0...50°C
Temperature Drift	Approx. 15ppm/K
Weight	21g
Ordering Information	Part No: 304.1090.001CA

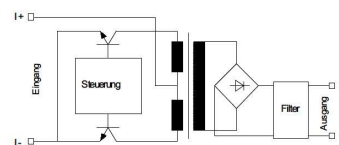
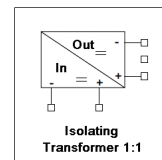

### Coating Option

We offer the USEUreg-series with optional coating. It is to be used in e.g. dusty, dirty, high humidity, or in awaiting quick temperature changes. Short circuit and corrosion at print board lines and at solder points can be prevented. The coat itself is a transparent acrylic resin. It is procured with a robotics varnishing machine.

Peters SL 1306 N-FLZ (transparent) IEC60216-1 2001, IPC-CC-830B, UL listed as permanent coating FileNo.: E80315, UL94V-0

Ordering Information: ad extension C to the complete type number: HSEUreg04801.180TC or HSEUreg04801T420C

Test	Time	A	B	C	D
Type Test	60s	2500Vac	3000Vac	500Vdc	500Vdc
Factory Test	5s	2000Vac	2000Vac	500Vdc	500Vdc
Field Test	2s	2000Vac	2000Vac	500Vdc	500Vdc

Type test and factory tests are conducted by the manufacturer. Do not repeat the test in field.  
Field test rules:

- Use appropriate test equipment which apply the voltage with a slow ramp
- Connect L1 and N together, as well as all output poles
- Use only AC test-voltages with 50/60Hz. The output voltages is floating and has no ohmic reference to ground.
- If testing output voltages are  $\geq 60Vdc$  remain to security directives. Use only isolated screw drivers to adjust output voltages.

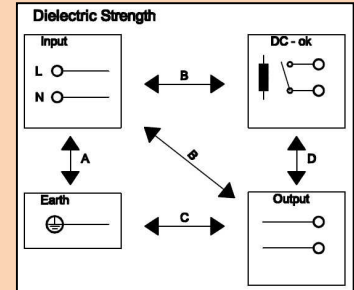

### Terminal Connects:

**AC Main Input**  
GND common  
N - wire  
L - wire

**DC Mains Outputs**  
DC + voltage  
DC + voltage  
DC - voltage  
DC - voltage

### Inputs/Outputs

Ureg = programmable voltage input  
Ureg = programmable current input  
SD = shut down input  
Sense = Sensing (compensation: 2V)

### Mechanics & Installation of the HSEUreg

Stable metal/aluminium housing IP20. To allow adequate convection, a free air space of 50mm (top/bottom) and 5mm (sidewalls) is required; for active devices 15mm space from the sidewalls. For free air convection it is necessary to install the HSEUreg horizontal. You can use the DIN-Rail installation (equiped standard) with our patented 35mm DIN-Rail bracket according to EN60275. It is easy to mount/dismount while snapping it onto the 35mm DIN-Rail - any tools necessary. A wallmount backplate (option) is available, too

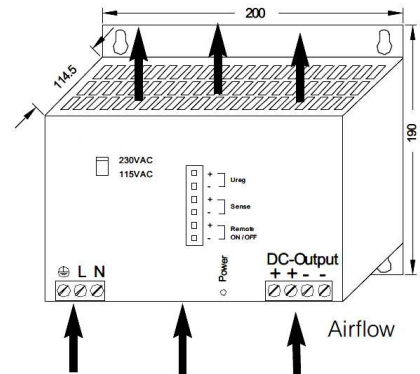
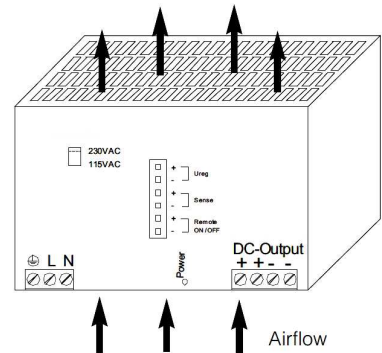
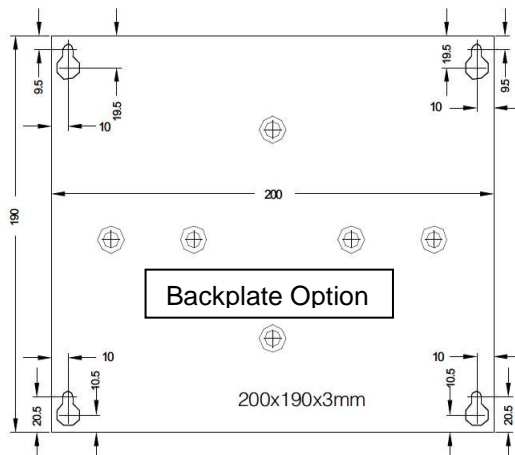
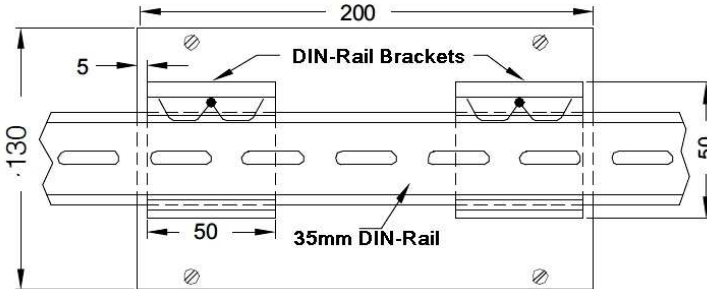

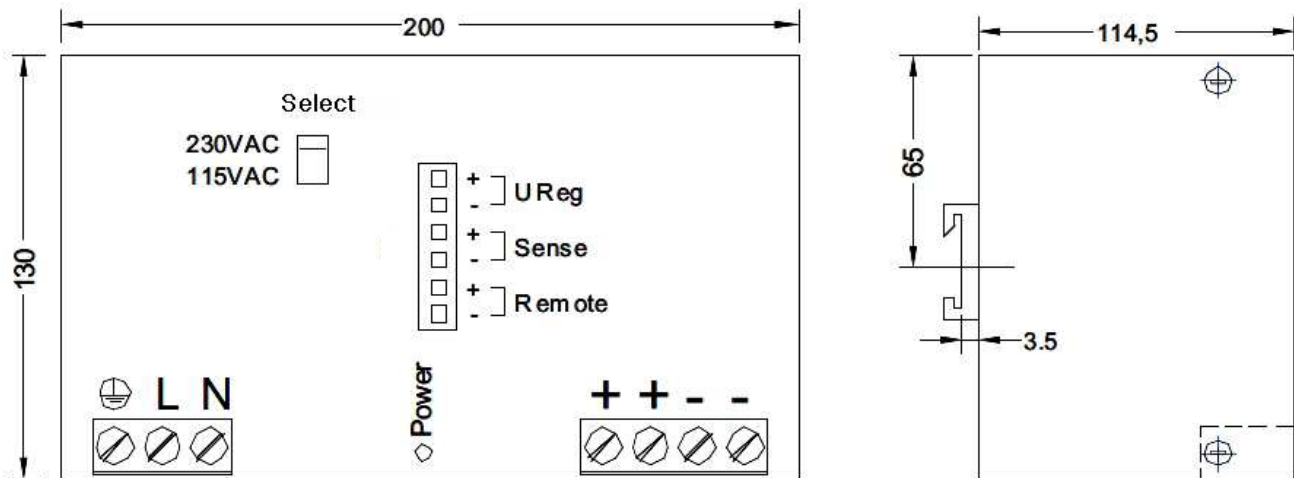

**Safety Instructions:** Please read all warnings and advices carefully before installing or operating the HSEUreg. Retain this operation manual always ready to hand. The HSEUreg must be installed by specialist staff only.

#### Installation:

- 1.) The HSEUreg is designed for systems fulfilling the safety norms of dangerous voltages/energy and fire prevention
- 2.) Installation is restricted to specialists only, make sure that the AC wire system is free of voltage
- 3.) Opening the HSEUreg, making any modifications to it, dismounting any screws from it, operating the HSEUreg out of specification and/or using it in appropriate area will inevitably result in losing manufactureres guarantee; we decline taking any responsibility for risk of damages caused to someones health or to any installed system.
- 4.) Attention: The HSEUreg has an internal input fuse. It is necessary to wire an automatic circuit braker to the line. We suggest to use a 16A-type with B-characteristic. It is verboten to operate the HSEUreg without protective earth wired. It essential to install a line switch before the HSEUreg.

#### Warnings:

**Disregard these warnings can cause fire, electric shock, serious accident and death.**

1. Never operate the HSEUreg without Protective Earth Conductor
2. Before connecting the HSEUreg to the AC wire system make all wires free of voltage and assure accidently switch on
3. Allow neat and professional cabling
4. Never open nor try to repair the HSEUreg by yourself. Inside are dangerous voltages that can cause electric shock hazard.
5. Avoid metal pieces or other conductive material to fall into the HSEUreg
6. Do not operate the HSEUreg under damp or wet conditions
7. It is verboten to operate the HSEUreg under Ex conditions or in Ex-Area 

All parameters base on 5 minutes run-in @ full load / 25°C / 230Vac 50/60Hz, as otherwise stated.