

Data sheet | Item number: 890-113

Plug; with strain relief housing; 3-pole; Cod. A

www.wago.com/890-113

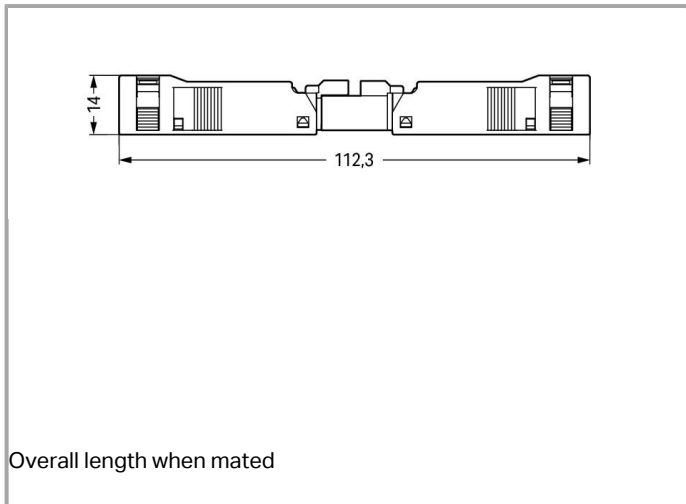
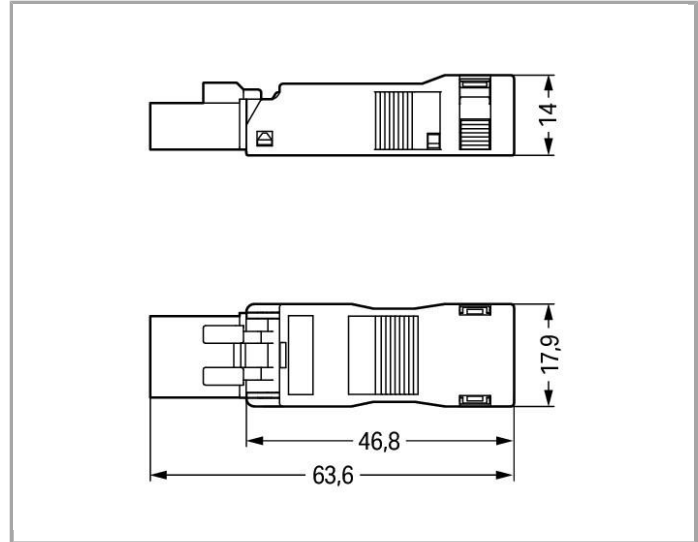

Overall length when mated

Item description

Note:

All connectors for mounted installations (snap-in versions for lighting fixtures or devices, all types of PCB and distribution connectors) are factory-equipped with locking levers to ensure plugs and sockets are securely locked. Additional locking levers are only required for flying leads (plug /socket).



Data

Electrical data

Ratings per IEC/EN 60664-1

Rated voltage (III / 3)	250 V
Rated impulse voltage (III / 3)	4 kV
Rated current	16 A
Legend (ratings)	(III / 3) ≙ Overvoltage category III / Pollution degree 3

Connection data

Connection technology	Push-in CAGE CLAMP®
Actuation type	Operating tool Push-in
Nominal cross section	1.5 mm ²
Solid conductor	0.25 ... 1.5 mm ² / 22 ... 16 AWG
Solid conductor, push-in termination	0.75 ... 1.5 mm ² / 20 ... 16 AWG
Stranded conductor	0.25 ... 1 mm ² / 22 ... 18 AWG
Fine-stranded conductor	0.25 ... 1.5 mm ² / 22 ... 16 AWG
Fine-stranded conductor with ferrule with plastic collar	0.25 ... 0.75 mm ² / 22 ... 20 AWG
Fine-stranded conductor with ferrule without plastic collar	0.25 ... 0.75 mm ² / 22 ... 20 AWG
Fine-stranded conductor with ferrule, push-in termination, from	0.75 mm ² / 20 AWG
Strip length	9 mm / 0.35 Inch
Note (strip length)	see also packaging or instructions
No. of poles	3
Total number of connection points	3
Total number of potentials	3
Ground function	with preceding GND contact
Connectable sheathed cable diameter	4.5 ... 10 mm
Conductor entry direction to mating direction	0°
Abmantellänge	40 mm

Geometrical Data

Pin spacing	4.4 mm (0.173 inch)
Width	17.9 mm / 0.705 inch
Height	14 mm / 0.551 inch
Depth	63.6 mm / 2.504 inch

Mechanical data

Coding	A
--------	---

Mating force of a plug-in connection	approx. 20 ... 70 N (depending on pole number)
Retention force of a plug-in connection	when locked: > 80N
Unmating force of a plug-in connection	when unlocked: approx. 20 ... 70 N (depending on pole number)
Marking	L N
Degree of protection	IP20
Potential marking	L N

Plug connection

Contact type (pluggable connector)	Male connector/plug
Connector connection type	for conductors
Mismating protection	Yes
Locking of plug-in connection	locking lever
Locking lever	no
Strain relief	Strain relief housing

Material Data

Color	black
Insulating material	Polyamide 66 (PA 66)
Flammability class per UL94	V0
Clamping spring material	Chrome nickel spring steel (CrNi)
Contact material	Copper or copper alloy, surface-treated
Fire load	0.238 MJ
Weight	8.471 g

Environmental Requirements

Surrounding air (operating) temperature	-35 ... 85 °C
---	---------------

Commercial data

Country of origin	DE
GTIN	4045454232900
Customs Tariff No.	85366990990
Product Group	20 (WINSTA)

Approvals / Certificates

Country specific Approvals

Logo	Approval	Certificate name
	CCA DEKRA Certification B.V.	2182129.01

CCA
DEKRA Certification B.V.

NL-35632

Ship Approvals



Logo	Approval	Certificate name
	DNV GL Det Norske Veritas, Germanischer Lloyd	TAE00001Z6

UL-Approvals

Logo	Approval	Certificate name
	UL UL International Germany GmbH	E45171

Compatible products

Locking lever

	Item no.: 890-101 Locking lever; manually operated	www.wago.com/890-101
	Item no.: 890-111 Locking lever; for tool operation; for "flying leads"	www.wago.com/890-111
	Item no.: 890-121 Locking lever; manually operated	www.wago.com/890-121
	Item no.: 890-131 Locking lever; for tool operation; for "flying leads"	www.wago.com/890-131



assembling

	Item no.: 890-310 Mounting carrier; for "flying leads"; 2- to 5-pole	www.wago.com/890-310
	Item no.: 890-311 Mounting carrier; for "flying leads"; 2- to 5-pole	www.wago.com/890-311

shield connection

	Item no.: 890-523 Shield connecting plate; for 3-pole plugs and sockets	www.wago.com/890-523
--	---	--

tools

	Item no.: 210-719 Operating tool with partially insulated shaft; Type 1, blade (2.5 x 0.4) mm	www.wago.com/210-719
	Item no.: 890-383 Operating tool; 3-way	www.wago.com/890-383



Downloads

Documentation

Bid Text

890-113	Sep 19, 2016	DOC	Download
WINSTA MINI 3-polig		23.6 kB	

smartDATA

CAD data

3D Download 890-113		URL	Download
---------------------	--	-----	----------

Subject to changes.