

Data sheet | Item number: 2006-1202

2-conductor through terminal block; 6 mm<sup>2</sup>; suitable for Ex e II applications;  
side and center marking; for DIN-rail 35 x 15 and 35 x 7.5; Push-in CAGE  
CLAMP®

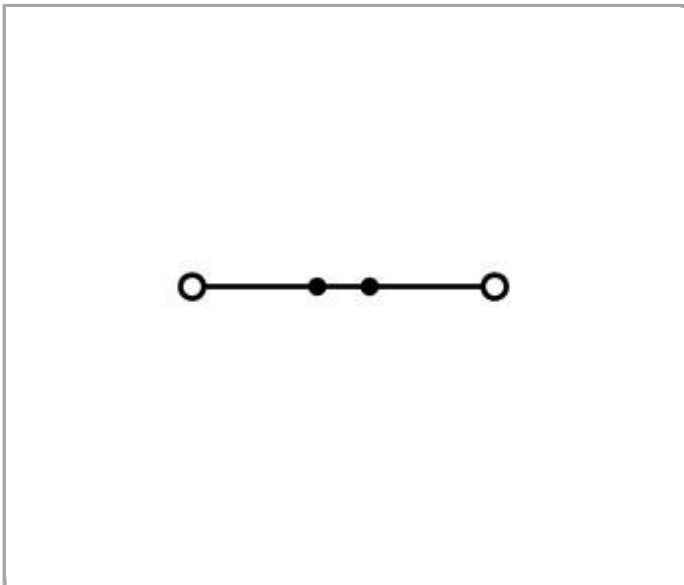

[www.wago.com/2006-1202](http://www.wago.com/2006-1202)

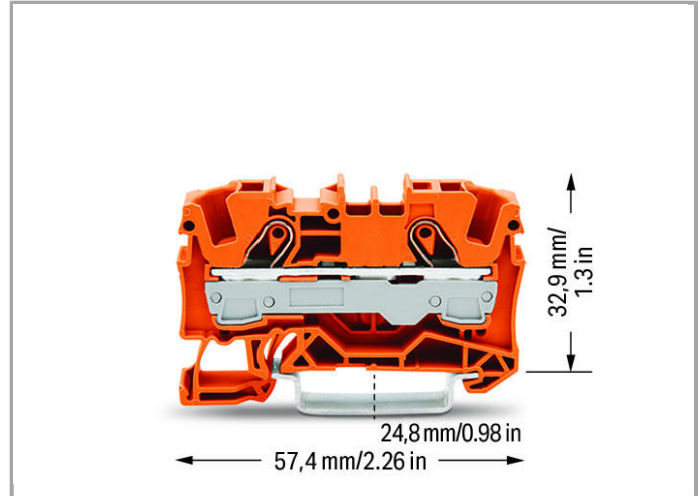
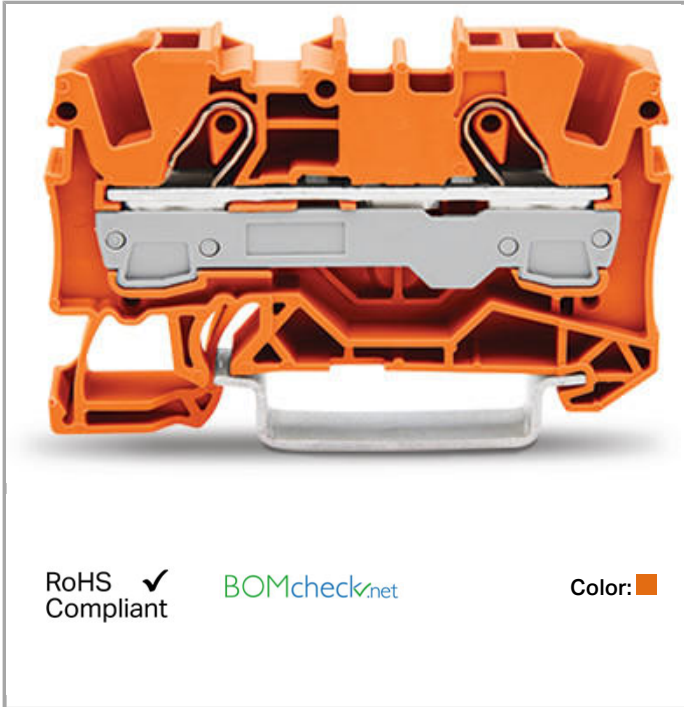

Data

Electrical data

Rated voltage EN (Ex e II)	550 V
Rated current (Ex e II)	38 A



Rated current (Ex e II) with jumper	33 A
-------------------------------------	------

### Ratings per IEC/EN 60664-1

Rated voltage (III / 3)	800 V
Rated impulse voltage (III / 3)	8 kV
Rated current	41 A
Rated current (2)	57 A
Legend (ratings)	(III / 3) ≙ Overvoltage category III / Pollution degree 3

### Approvals per UL 1059

Rated voltage UL (Use Group B)	600 V
Rated current UL (Use Group B)	50 A
Rated voltage UL (Use Group C)	600 V
Rated current UL (Use Group C)	50 A

### Approvals per CSA

Rated voltage CSA (Use Group B)	600 V
Rated current CSA (Use Group B)	50 A
Rated voltage CSA (Use Group C)	600 V
Rated current CSA (Use Group C)	50 A

### Connection data

Connection technology	Push-in CAGE CLAMP®
Actuation type	Push-in Operating tool
Connectable conductor materials	Copper
Nominal cross section	6 mm <sup>2</sup>
Solid conductor	0.5 ... 10 mm <sup>2</sup> / 20 ... 8 AWG
Solid conductor, push-in termination	2.5 ... 10 mm <sup>2</sup> / 14 ... 8 AWG
Fine-stranded conductor	0.5 ... 10 mm <sup>2</sup> / 20 ... 8 AWG
Fine-stranded conductor with ferrule, push-in termination, from	2.5 mm <sup>2</sup> / 16 AWG
Strip length	13 ... 15 mm / 0.51 ... 0.59 Inch
Total number of connection points	2
Total number of potentials	1
Number of levels	1
Type of wiring	Front-entry wiring

### Geometrical Data

Width	7.5 mm / 0.295 inch
Height from upper-edge of DIN-35 rail	32.9 mm / 1.295 inch

Depth	57.5 mm / 2.264 inch
-------	----------------------

### Mechanical data

Design	horizontal
Type of mounting	DIN-35 rail
Marking level	Center/side marking

### Material Data

Color	orange
Insulating material	Polyamide 66 (PA 66)
Fire load	0.154 MJ
Weight	8.893 g

### Commercial data

Country of origin	DE
GTIN	4017332999663
Customs Tariff No.	85369010000
Product Group	22 (TOPJOB S)

### Approvals / Certificates

#### Ex-Approvals



Logo	Approval	Certificate name
	ATEX Physikalisch Technische Bundesanstalt (PTB)	PTB 05 ATEX 1030 U (II 2 G Ex eII bzw. IM 2 Exe I)
	IECEX Physikalisch Technische Bundesanstalt (PTB)	IECEX PTB 03.0014 U (Ex eII C Gb and Ex eI Mb)

#### Country specific Approvals

Logo	Approval	Certificate name
	CCA DEKRA Certification B.V.	NTR NL 7311
	CCA DEKRA Certification B.V.	71-101179
	CSA DEKRA Certification B.V.	1543858



## Ship Approvals



Logo	Approval	Certificate name
	<b>ABS</b> American Bureau of Shipping	14-HG1293677-PDA
	<b>BV</b> Bureau Veritas S.A.	38586/A0 BV
	<b>LR</b> Lloyds Register	91/20112 (E9)

## UL-Approvals

Logo	Approval	Certificate name
	<b>UL</b> UL International Germany GmbH	E45172

## Compatible products

## End plate

	<b>Item no.: 2006-1291</b> End and intermediate plate; 1 mm thick	<a href="http://www.wago.com/2006-1291">www.wago.com/2006-1291</a>
	<b>Item no.: 2006-1292</b> End and intermediate plate; 1 mm thick	<a href="http://www.wago.com/2006-1292">www.wago.com/2006-1292</a>
	<b>Item no.: 2006-1293</b> Separator plate; 2 mm thick; oversized	<a href="http://www.wago.com/2006-1293">www.wago.com/2006-1293</a>
	<b>Item no.: 2006-1294</b> Separator plate; 2 mm thick; oversized	<a href="http://www.wago.com/2006-1294">www.wago.com/2006-1294</a>
	<b>Item no.: 209-191</b> Separator for Ex e/Ex i applications; 3 mm thick; 120 mm wide	<a href="http://www.wago.com/209-191">www.wago.com/209-191</a>

## Protective Warning Marker

	<b>Item no.: 2006-115</b> Protective warning marker; with high-voltage symbol, black; for 5 terminal blocks	<a href="http://www.wago.com/2006-115">www.wago.com/2006-115</a>
--	--	--

## General accessories



**Item no.: 2006-191**  
Lockout cap; for wire insertion and actuating opening

[www.wago.com/2006-191](http://www.wago.com/2006-191)

## Jumper



**Item no.: 2006-402**  
Push-in type jumper bar; insulated; 2-way; Nominal current 41 A

[www.wago.com/2006-402](http://www.wago.com/2006-402)



**Item no.: 2006-403**  
Push-in type jumper bar; insulated; 3-way; Nominal current 41 A

[www.wago.com/2006-403](http://www.wago.com/2006-403)



**Item no.: 2006-404**  
Push-in type jumper bar; insulated; 4-way; Nominal current 41 A

[www.wago.com/2006-404](http://www.wago.com/2006-404)



**Item no.: 2006-405**  
Push-in type jumper bar; insulated; 5-way; Nominal current 41 A

[www.wago.com/2006-405](http://www.wago.com/2006-405)



**Item no.: 2006-405/011-000**  
Star point jumper; insulated; 3-way (1-3-5); IN = IN terminal block

[www.wago.com/2006-405/011-000](http://www.wago.com/2006-405/011-000)



**Item no.: 2006-433**  
Push-in type jumper bar; insulated; from 1 to 3; Nominal current 41 A

[www.wago.com/2006-433](http://www.wago.com/2006-433)



**Item no.: 2006-434**  
Push-in type jumper bar; insulated; from 1 to 4; Nominal current 41 A

[www.wago.com/2006-434](http://www.wago.com/2006-434)



**Item no.: 2006-435**  
Push-in type jumper bar; insulated; from 1 to 5; Nominal current 41 A

[www.wago.com/2006-435](http://www.wago.com/2006-435)



**Item no.: 2006-499**  
Step-down jumper; insulated; from 6/4 mm<sup>2</sup> to 4/2.5/1.5 mm<sup>2</sup>; Nominal current 32 A

[www.wago.com/2006-499](http://www.wago.com/2006-499)



**Item no.: 2016-499**  
Step-down jumper; insulated; from 16/10 mm<sup>2</sup> to 10/6/4/2.5 mm<sup>2</sup>; Nominal current 57 A

[www.wago.com/2016-499](http://www.wago.com/2016-499)



**Item no.: 210-103**  
Wire commoning chain; insulated; 50 connections

[www.wago.com/210-103](http://www.wago.com/210-103)

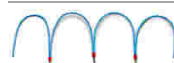

**Item no.: 210-123**  
Wire commoning chain; insulated; 50 connections

[www.wago.com/210-123](http://www.wago.com/210-123)

## check



**Item no.: 2006-511**  
Modular TOPJOB®S connector; modular; for jumper contact slot; 1-pole

[www.wago.com/2006-511](http://www.wago.com/2006-511)



**Item no.: 2006-549**  
Spacer module; modular; e.g., for bridging commoned terminal blocks

[www.wago.com/2006-549](http://www.wago.com/2006-549)



**Item no.: 2009-174**  
Test plug adapter; for 4 mm Ø test plugs; for testing TOPJOB®S rail-mounted terminal blocks

[www.wago.com/2009-174](http://www.wago.com/2009-174)



**Item no.: 2009-182**  
Testing tap; for max. 2.5 mm<sup>2</sup>; tool-free connection for individual test wires 0.08 - 2.5 mm

[www.wago.com/2009-182](http://www.wago.com/2009-182)



**Item no.: 210-136**  
Test plug; 2 mm Ø; with 500 mm cable

[www.wago.com/210-136](http://www.wago.com/210-136)

## tools

**Item no.: 210-721**

Operating tool with partially insulated shaft; Type 3, blade (5.5 x 0.8) mm

[www.wago.com/210-721](http://www.wago.com/210-721)

## Carrier rail

**Item no.: 210-112**

Steel carrier rail; 35 x 7.5 mm; 1 mm thick; 2 m long; slotted; according to EN 60715; "Hole width 25 mm

[www.wago.com/210-112](http://www.wago.com/210-112)**Item no.: 210-113**

Steel carrier rail; 35 x 7.5 mm; 1 mm thick; 2 m long; unslotted; according to EN 60715

[www.wago.com/210-113](http://www.wago.com/210-113)**Item no.: 210-114**

Steel carrier rail; 35 x 15 mm; 1.5 mm thick; 2 m long; unslotted; similar to EN 60715

[www.wago.com/210-114](http://www.wago.com/210-114)**Item no.: 210-115**

Steel carrier rail; 35 x 7.5 mm; 1 mm thick; 2 m long; slotted; according to EN 60715; "Hole width 18 mm

[www.wago.com/210-115](http://www.wago.com/210-115)**Item no.: 210-118**

Steel carrier rail; 35 x 15 mm; 2.3 mm thick; 2 m long; unslotted; according to EN 60715

[www.wago.com/210-118](http://www.wago.com/210-118)**Item no.: 210-196**

Aluminum carrier rail; 35 x 8.2 mm; 1.6 mm thick; 2 m long; unslotted; similar to EN 60715

[www.wago.com/210-196](http://www.wago.com/210-196)**Item no.: 210-197**

Steel carrier rail; 35 x 15 mm; 1.5 mm thick; 2 m long; slotted; similar to EN 60715

[www.wago.com/210-197](http://www.wago.com/210-197)**Item no.: 210-198**

Copper carrier rail; 35 x 15 mm; 2.3 mm thick; 2 m long; unslotted; according to EN 60715

[www.wago.com/210-198](http://www.wago.com/210-198)

## Marking accessories

**Item no.: 2009-110**

Marking strips; on reel; not stretchable; plain; snap-on type

[www.wago.com/2009-110](http://www.wago.com/2009-110)**Item no.: 2009-115**

WMB-Inline; for smartPRINTER; on reel; stretchable 5 - 5.2 mm; plain; snap-on type

[www.wago.com/2009-115](http://www.wago.com/2009-115)**Item no.: 2009-115/000-002**

WMB-Inline; for smartPRINTER; on reel; stretchable 5 - 5.2 mm; plain; snap-on type

[www.wago.com/2009-115/000-002](http://www.wago.com/2009-115/000-002)**Item no.: 2009-115/000-006**

WMB-Inline; for smartPRINTER; on reel; stretchable 5 - 5.2 mm; plain; snap-on type

















[www.wago.com/2009-115/000-006](http://www.wago.com/2009-115/000-006)**Item no.: 2009-115/000-007**

WMB-Inline; for smartPRINTER; on reel; stretchable 5 - 5.2 mm; plain; snap-on type

[www.wago.com/2009-115/000-007](http://www.wago.com/2009-115/000-007)**Item no.: 2009-115/000-012**

WMB-Inline; for smartPRINTER; on reel; stretchable 5 - 5.2 mm; plain; snap-on type

[www.wago.com/2009-115/000-012](http://www.wago.com/2009-115/000-012)

	<b>Item no.: 2009-115/000-017</b> WMB-Inline; for smartPRINTER; on reel; stretchable 5 - 5.2 mm; plain; snap-on type	<a href="http://www.wago.com/2009-115/000-017">www.wago.com/2009-115/000-017</a>
	<b>Item no.: 2009-115/000-023</b> WMB-Inline; for smartPRINTER; on reel; stretchable 5 - 5.2 mm; plain; snap-on type	<a href="http://www.wago.com/2009-115/000-023">www.wago.com/2009-115/000-023</a>
	<b>Item no.: 2009-115/000-024</b> WMB-Inline; for smartPRINTER; on reel; stretchable 5 - 5.2 mm; plain; snap-on type	<a href="http://www.wago.com/2009-115/000-024">www.wago.com/2009-115/000-024</a>
	<b>Item no.: 2009-145</b> Mini-WSB Inline; for smartPRINTER; on reel; stretchable 5 - 5.2 mm; plain; snap-on type	<a href="http://www.wago.com/2009-145">www.wago.com/2009-145</a>
	<b>Item no.: 2009-145/000-002</b> Mini-WSB Inline; for smartPRINTER; on reel; stretchable 5 - 5.2 mm; plain; snap-on type	<a href="http://www.wago.com/2009-145/000-002">www.wago.com/2009-145/000-002</a>
	<b>Item no.: 2009-145/000-005</b> Mini-WSB Inline; for smartPRINTER; on reel; stretchable 5 - 5.2 mm; plain; snap-on type	<a href="http://www.wago.com/2009-145/000-005">www.wago.com/2009-145/000-005</a>
	<b>Item no.: 2009-145/000-006</b> Mini-WSB Inline; for smartPRINTER; on reel; stretchable 5 - 5.2 mm; plain; snap-on type	<a href="http://www.wago.com/2009-145/000-006">www.wago.com/2009-145/000-006</a>
	<b>Item no.: 2009-145/000-007</b> Mini-WSB Inline; for smartPRINTER; on reel; stretchable 5 - 5.2 mm; plain; snap-on type	<a href="http://www.wago.com/2009-145/000-007">www.wago.com/2009-145/000-007</a>
	<b>Item no.: 2009-145/000-012</b> Mini-WSB Inline; for smartPRINTER; on reel; stretchable 5 - 5.2 mm; plain; snap-on type	<a href="http://www.wago.com/2009-145/000-012">www.wago.com/2009-145/000-012</a>
	<b>Item no.: 2009-145/000-023</b> Mini-WSB Inline; for smartPRINTER; on reel; stretchable 5 - 5.2 mm; plain; snap-on type	<a href="http://www.wago.com/2009-145/000-023">www.wago.com/2009-145/000-023</a>
	<b>Item no.: 2009-145/000-024</b> Mini-WSB Inline; on reel; stretchable 5 - 5.2 mm; plain; snap-on type	<a href="http://www.wago.com/2009-145/000-024">www.wago.com/2009-145/000-024</a>
	<b>Item no.: 2009-191</b> Group marker carrier	<a href="http://www.wago.com/2009-191">www.wago.com/2009-191</a>
	<b>Item no.: 2009-192</b> Group marker carrier	<a href="http://www.wago.com/2009-192">www.wago.com/2009-192</a>
	<b>Item no.: 2009-193</b> Group marker carrier	<a href="http://www.wago.com/2009-193">www.wago.com/2009-193</a>
	<b>Item no.: 2009-198</b> Adaptor	<a href="http://www.wago.com/2009-198">www.wago.com/2009-198</a>
	<b>Item no.: 248-501</b> Miniature WSB Quick marking system; plain; Marker width 5 mm; 10 strips with 10 markers per card	<a href="http://www.wago.com/248-501">www.wago.com/248-501</a>



**Item no.: 248-501/000-002**  
Mini-WSB marking card; as card; not stretchable; plain; snap-on type

[www.wago.com/248-501/000-002](http://www.wago.com/248-501/000-002)



**Item no.: 248-501/000-005**  
Mini-WSB marking card; as card; plain; snap-on type

[www.wago.com/248-501/000-005](http://www.wago.com/248-501/000-005)



**Item no.: 248-501/000-006**  
Mini-WSB marking card; as card; not stretchable; plain; snap-on type

[www.wago.com/248-501/000-006](http://www.wago.com/248-501/000-006)



**Item no.: 248-501/000-007**  
Mini-WSB marking card; as card; not stretchable; plain; snap-on type

[www.wago.com/248-501/000-007](http://www.wago.com/248-501/000-007)



**Item no.: 248-501/000-012**  
Mini-WSB marking card; as card; not stretchable; plain; snap-on type

[www.wago.com/248-501/000-012](http://www.wago.com/248-501/000-012)



**Item no.: 248-501/000-017**  
Mini-WSB marking card; as card; not stretchable; plain; snap-on type

[www.wago.com/248-501/000-017](http://www.wago.com/248-501/000-017)



**Item no.: 248-501/000-023**  
Mini-WSB marking card; as card; not stretchable; plain; snap-on type

[www.wago.com/248-501/000-023](http://www.wago.com/248-501/000-023)



**Item no.: 248-501/000-024**  
Mini-WSB marking card; as card; not stretchable; plain; snap-on type

[www.wago.com/248-501/000-024](http://www.wago.com/248-501/000-024)



**Item no.: 793-501**  
WMB marking card; as card; not stretchable; plain; snap-on type

[www.wago.com/793-501](http://www.wago.com/793-501)



**Item no.: 793-501/000-002**  
WMB marking card; as card; not stretchable; plain; snap-on type

[www.wago.com/793-501/000-002](http://www.wago.com/793-501/000-002)



**Item no.: 793-501/000-005**  
WMB marking card; as card; not stretchable; plain; snap-on type

[www.wago.com/793-501/000-005](http://www.wago.com/793-501/000-005)



**Item no.: 793-501/000-006**  
WMB marking card; as card; not stretchable; plain; snap-on type

[www.wago.com/793-501/000-006](http://www.wago.com/793-501/000-006)



**Item no.: 793-501/000-007**  
WMB marking card; as card; not stretchable; plain; snap-on type

[www.wago.com/793-501/000-007](http://www.wago.com/793-501/000-007)



**Item no.: 793-501/000-012**  
WMB marking card; as card; not stretchable; plain; snap-on type















[www.wago.com/793-501/000-012](http://www.wago.com/793-501/000-012)



**Item no.: 793-501/000-017**  
WMB marking card; as card; not stretchable; plain; snap-on type

[www.wago.com/793-501/000-017](http://www.wago.com/793-501/000-017)



	<b>Item no.: 793-501/000-023</b> WMB marking card; as card; not stretchable; plain; snap-on type	<a href="http://www.wago.com/793-501/000-023">www.wago.com/793-501/000-023</a>
	<b>Item no.: 793-501/000-024</b> WMB marking card; as card; not stretchable; plain; snap-on type	<a href="http://www.wago.com/793-501/000-024">www.wago.com/793-501/000-024</a>
	<b>Item no.: 793-5501</b> WMB marking card; as card; for terminal block width 5 - 17.5 mm; stretchable 5 - 5.2 mm; plain; snap-on type	<a href="http://www.wago.com/793-5501">www.wago.com/793-5501</a>
	<b>Item no.: 793-5501/000-002</b> WMB marking card; as card; for terminal block width 5 - 17.5 mm; stretchable 5 - 5.2 mm; plain; snap-on type	<a href="http://www.wago.com/793-5501/000-002">www.wago.com/793-5501/000-002</a>
	<b>Item no.: 793-5501/000-005</b> WMB marking card; as card; stretchable 5 - 5.2 mm; plain; snap-on type	<a href="http://www.wago.com/793-5501/000-005">www.wago.com/793-5501/000-005</a>
	<b>Item no.: 793-5501/000-006</b> WMB marking card; as card; stretchable 5 - 5.2 mm; plain; snap-on type	<a href="http://www.wago.com/793-5501/000-006">www.wago.com/793-5501/000-006</a>
	<b>Item no.: 793-5501/000-007</b> WMB marking card; as card; stretchable 5 - 5.2 mm; plain; snap-on type	<a href="http://www.wago.com/793-5501/000-007">www.wago.com/793-5501/000-007</a>
	<b>Item no.: 793-5501/000-012</b> WMB marking card; as card; stretchable 5 - 5.2 mm; plain; snap-on type	<a href="http://www.wago.com/793-5501/000-012">www.wago.com/793-5501/000-012</a>
	<b>Item no.: 793-5501/000-017</b> WMB marking card; as card; stretchable 5 - 5.2 mm; plain; snap-on type	<a href="http://www.wago.com/793-5501/000-017">www.wago.com/793-5501/000-017</a>
	<b>Item no.: 793-5501/000-023</b> WMB marking card; as card; stretchable 5 - 5.2 mm; plain; snap-on type	<a href="http://www.wago.com/793-5501/000-023">www.wago.com/793-5501/000-023</a>
	<b>Item no.: 793-5501/000-024</b> WMB marking card; as card; stretchable 5 - 5.2 mm; plain; snap-on type	<a href="http://www.wago.com/793-5501/000-024">www.wago.com/793-5501/000-024</a>
<b>ferrule</b>		
	<b>Item no.: 216-208</b> Ferrule; Sleeve for 6 mm <sup>2</sup> / AWG 10; insulated; electro-tin plated; electrolytic copper; gastight crimped; acc. to DIN 46228, Part 4/09.90	<a href="http://www.wago.com/216-208">www.wago.com/216-208</a>
	<b>Item no.: 216-262</b> Ferrule; Sleeve for 0.75 mm <sup>2</sup> / AWG 20; insulated; electro-tin plated; electrolytic copper; gastight crimped; acc. to DIN 46228, Part 4/09.90	<a href="http://www.wago.com/216-262">www.wago.com/216-262</a>
	<b>Item no.: 216-263</b> Ferrule; Sleeve for 1 mm <sup>2</sup> / AWG 18; insulated; electro-tin plated; electrolytic copper; gastight crimped; acc. to DIN 46228, Part 4/09.90	<a href="http://www.wago.com/216-263">www.wago.com/216-263</a>
	<b>Item no.: 216-264</b> Ferrule; Sleeve for 1.5 mm <sup>2</sup> / AWG 16; insulated; electro-tin plated; electrolytic copper; gastight crimped; acc. to DIN 46228, Part 4/09.90	<a href="http://www.wago.com/216-264">www.wago.com/216-264</a>



**Item no.: 216-266**

Ferrule; Sleeve for 2.5 mm<sup>2</sup> / AWG 14; insulated; electro-tin plated; electrolytic copper; gastight crimped; acc. to DIN 46228, Part 4/09.90

[www.wago.com/216-266](http://www.wago.com/216-266)



**Item no.: 216-267**

Ferrule; Sleeve for 4 mm<sup>2</sup> / AWG 12; insulated; electro-tin plated; electrolytic copper; gastight crimped; acc. to DIN 46228, Part 4/09.90

[www.wago.com/216-267](http://www.wago.com/216-267)

## Downloads

### Documentation

#### Bid Text

2006-1202	Aug 13, 2018	DOCX	Download
Reihenklempen, TOPJOB S		15.0 kB	

## smartDATA

### CAD data

3D Download 2006-1202	URL	Download
-----------------------	-----	----------

## Product family

### TOPJOB® S

TOPJOB® S: In various industrial applications and modern building installations, WAGO's wide and versatile range of rail-mount terminal blocks provides more than just reliable electrical connections.

[Learn more about the product family.](#)

[Show all products from the family](#)

Subject to changes.