

Data sheet | Item number: 279-101

2-conductor through terminal block; 1.5 mm²; lateral marker slots; for DIN-rail 35 x 15 and 35 x 7.5; CAGE CLAMP®

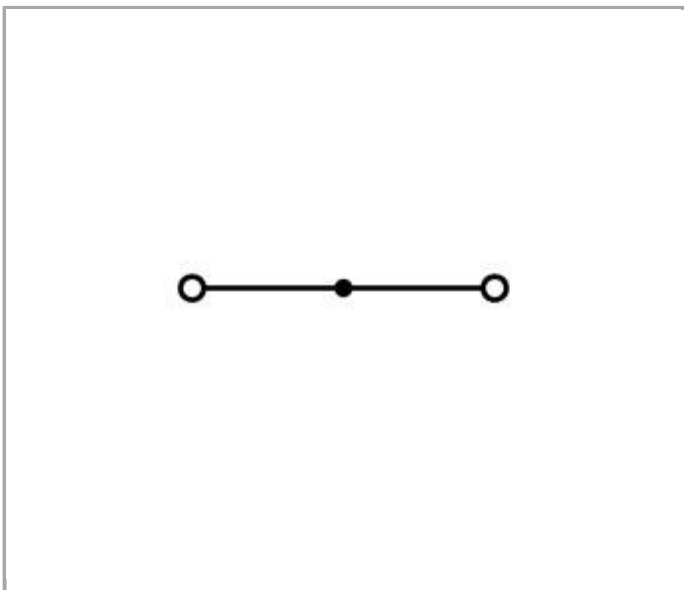

www.wago.com/279-101

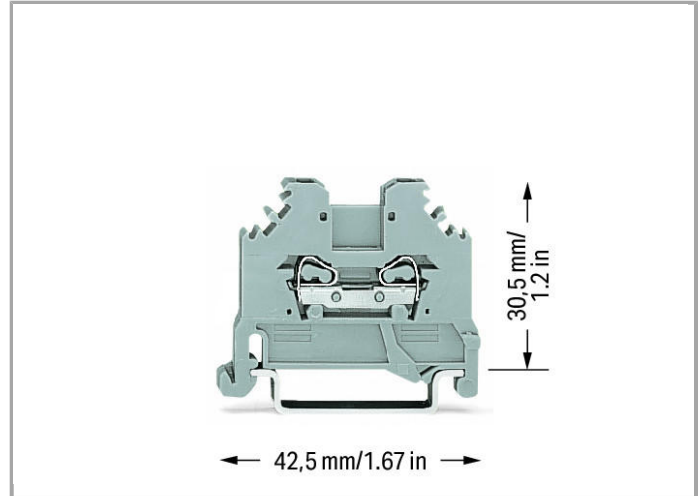
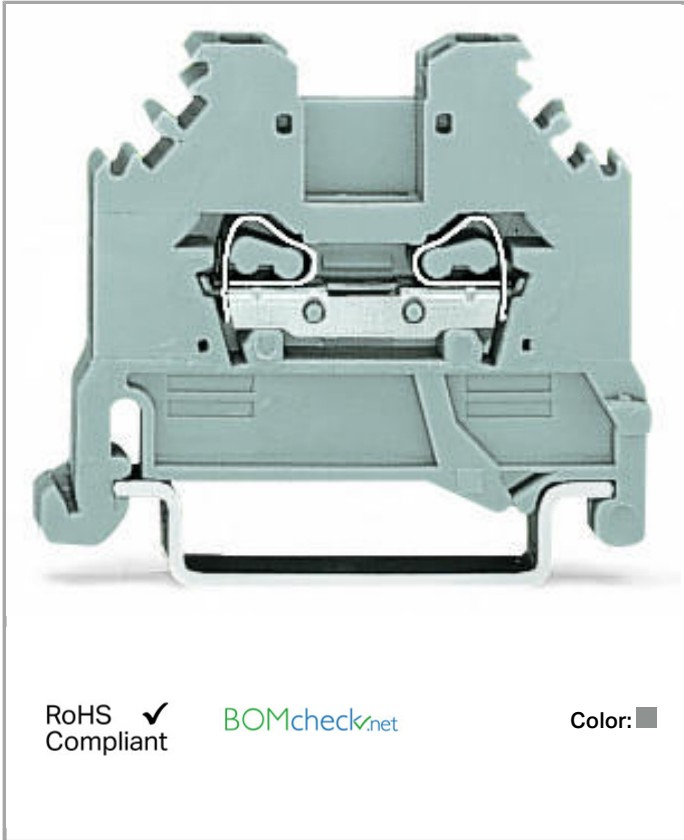

Data



Electrical data

Ratings per IEC/EN 60664-1

Rated voltage (III / 3)	800 V
Rated impulse voltage (III / 3)	8 kV
Rated current	18 A
Legend (ratings)	(III / 3) \triangleq Overvoltage category III / Pollution degree 3

Connection data

Connection technology	CAGE CLAMP®
Actuation type	Operating tool
Connectable conductor materials	Copper Aluminum
Solid conductor	0.08 ... 1.5 mm ² / 28 ... 16 AWG
Fine-stranded conductor	0.08 ... 1.5 mm ² / 28 ... 16 AWG
Strip length	8 ... 9 mm / 0.31 ... 0.35 Inch
Total number of connection points	2
Total number of potentials	1
Number of levels	1
Type of wiring	Side-entry wiring

Geometrical Data

Width	4 mm / 0.157 inch
Height from upper-edge of DIN-35 rail	30.5 mm / 1.201 inch
Depth	42.5 mm / 1.673 inch

Mechanical data

Design	horizontal
Type of mounting	DIN-35 rail
Marking level	Side marking

Material Data

Color	gray
Insulating material	Polyamide 66 (PA 66)
Fire load	0.069 MJ
Weight	3.168 g

Commercial data

GTIN	4050821413066
------	---------------

Product Group



1 (Rail Mounted Terminal Blocks)

Approvals / Certificates

Country specific Approvals

Logo	Approval	Certificate name
	CCA DEKRA Certification B.V.	NTR NL-7081
	KEMA/KEUR DEKRA Certification B.V.	2160584.04

Ship Approvals



Logo	Approval	Certificate name
	ABS American Bureau of Shipping	14-HG1293677-PDA
	BV Bureau Veritas S.A.	07436/E0 BV
	LR Lloyds Register	91/20112 (E9)

















UL-Approvals









Logo	Approval	Certificate name
	UR Underwriters Laboratories Inc.	E45172

Compatible products



ferrule











	Item no.: 216-101 Ferrule; Sleeve for 0.5 mm ² / AWG 22; uninsulated; electro-tin plated	www.wago.com/216-101
	Item no.: 216-102 Ferrule; Sleeve for 0.75 mm ² / AWG 20; uninsulated; electro-tin plated	www.wago.com/216-102
	Item no.: 216-103 Ferrule; Sleeve for 1 mm ² / AWG 18; uninsulated; electro-tin plated	www.wago.com/216-103

	Item no.: 216-201 Ferrule; Sleeve for 0.5 mm ² / AWG 22; insulated; electro-tin plated	www.wago.com/216-201
	Item no.: 216-202 Ferrule; Sleeve for 0.75 mm ² / AWG 20; insulated; electro-tin plated	www.wago.com/216-202
	Item no.: 216-203 Ferrule; Sleeve for 1 mm ² / AWG 18; insulated; electro-tin plated	www.wago.com/216-203
	Item no.: 216-301 Ferrule; Sleeve for 0.25 mm ² / AWG 24; insulated; electro-tin plated	www.wago.com/216-301
	Item no.: 216-302 Ferrule; Sleeve for 0.34 mm ² / AWG 24; insulated; electro-tin plated	www.wago.com/216-302
assembling		
	Item no.: 209-106 Mounting carrier; for isolated mounting on DIN 35 rails	www.wago.com/209-106
	Item no.: 709-153 Cover; Type 1; suitable for cover carrier, type 1; 1 m long	www.wago.com/709-153
End plate		
	Item no.: 280-301 End and intermediate plate; 2.5 mm thick	www.wago.com/280-301
	Item no.: 280-302 End and intermediate plate; 2.5 mm thick	www.wago.com/280-302
	Item no.: 280-322 Separator plate; 2 mm thick; oversized	www.wago.com/280-322
	Item no.: 280-332 Separator plate; 2 mm thick; oversized	www.wago.com/280-332
	Item no.: 281-333 Step-down intermediate plate; 1 mm thick; "only for 4 mm terminal blocks	www.wago.com/281-333
	Item no.: 281-336 Step-down intermediate plate; 1 mm thick; "only for 4 mm terminal blocks	www.wago.com/281-336
Carrier rail		
	Item no.: 210-112 Steel carrier rail; 35 x 7.5 mm; 1 mm thick; 2 m long; slotted; according to EN 60715; "Hole width 25 mm	www.wago.com/210-112
	Item no.: 210-113 Steel carrier rail; 35 x 7.5 mm; 1 mm thick; 2 m long; unslotted; according to EN 60715	www.wago.com/210-113
	Item no.: 210-114 Steel carrier rail; 35 x 15 mm; 1.5 mm thick; 2 m long; unslotted; similar to EN 60715	www.wago.com/210-114
	Item no.: 210-115 Steel carrier rail; 35 x 7.5 mm; 1 mm thick; 2 m long; slotted; according to EN 60715; "Hole width 18 mm	www.wago.com/210-115

	Item no.: 210-118 Steel carrier rail; 35 x 15 mm; 2.3 mm thick; 2 m long; unslotted; according to EN 60715	www.wago.com/210-118
	Item no.: 210-196 Aluminum carrier rail; 35 x 8.2 mm; 1.6 mm thick; 2 m long; unslotted; similar to EN 60715	www.wago.com/210-196
	Item no.: 210-197 Steel carrier rail; 35 x 15 mm; 1.5 mm thick; 2 m long; slotted; similar to EN 60715	www.wago.com/210-197
	Item no.: 210-198 Copper carrier rail; 35 x 15 mm; 2.3 mm thick; 2 m long; unslotted; according to EN 60715	www.wago.com/210-198
	Item no.: 210-504 Steel carrier rail; 35 x 7.5 mm; 1 mm thick; 2 m long; slotted; galvanized; according to EN 60715	www.wago.com/210-504
	Item no.: 210-505 Steel carrier rail; 35 x 7.5 mm; 1 mm thick; 2 m long; unslotted; galvanized; according to EN 60715	www.wago.com/210-505
	Item no.: 210-506 Steel carrier rail; 35 x 15 mm; 1.5 mm thick; 2 m long; unslotted; galvanized; similar to EN 60715	www.wago.com/210-506
	Item no.: 210-508 Steel carrier rail; 35 x 15 mm; 1.5 mm thick; 2 m long; slotted; galvanized; similar to EN 60715	www.wago.com/210-508

Marking accessories



	Item no.: 2009-114 WMB-Inline; for smartPRINTER; on reel; stretchable 4 - 4.2 mm; plain; snap-on type	www.wago.com/2009-114
	Item no.: 2009-114/000-002 WMB-Inline; for smartPRINTER; on reel; stretchable 4 - 4.2 mm; plain; snap-on type	www.wago.com/2009-114/000-002
	Item no.: 2009-114/000-005 WMB-Inline; for smartPRINTER; on reel; stretchable 4 - 4.2 mm; plain; snap-on type	www.wago.com/2009-114/000-005
	Item no.: 2009-114/000-006 WMB-Inline; for smartPRINTER; on reel; stretchable 4 - 4.2 mm; plain; snap-on type	www.wago.com/2009-114/000-006
	Item no.: 2009-114/000-007 WMB-Inline; for smartPRINTER; on reel; stretchable 4 - 4.2 mm; plain; snap-on type	www.wago.com/2009-114/000-007
	Item no.: 2009-114/000-012 WMB-Inline; for smartPRINTER; on reel; stretchable 4 - 4.2 mm; plain; snap-on type	www.wago.com/2009-114/000-012
	Item no.: 2009-114/000-023 WMB-Inline; for smartPRINTER; on reel; stretchable 4 - 4.2 mm; plain; snap-on type	www.wago.com/2009-114/000-023
	Item no.: 2009-114/000-024 WMB-Inline; for smartPRINTER; on reel; stretchable 4 - 4.2 mm; plain; snap-on type	www.wago.com/2009-114/000-024
	Item no.: 209-140 Group marker carrier	www.wago.com/209-140





	Item no.: 209-141 Group marker carrier	www.wago.com/209-141
	Item no.: 209-142 Group marker carrier	www.wago.com/209-142
	Item no.: 793-4501 WMB marking card; as card; stretchable 4 - 4.2 mm; plain; snap-on type	www.wago.com/793-4501
	Item no.: 793-4501/000-002 WMB marking card; as card; stretchable 4 - 4.2 mm; plain; snap-on type	www.wago.com/793-4501/000-002
	Item no.: 793-4501/000-005 WMB marking card; as card; stretchable 4 - 4.2 mm; plain; snap-on type	www.wago.com/793-4501/000-005
	Item no.: 793-4501/000-006 WMB marking card; as card; stretchable 4 - 4.2 mm; plain; snap-on type	www.wago.com/793-4501/000-006
	Item no.: 793-4501/000-007 WMB marking card; as card; stretchable 4 - 4.2 mm; plain; snap-on type	www.wago.com/793-4501/000-007
	Item no.: 793-4501/000-012 WMB marking card; as card; stretchable 4 - 4.2 mm; plain; snap-on type	www.wago.com/793-4501/000-012
	Item no.: 793-4501/000-017 WMB marking card; as card; stretchable 4 - 4.2 mm; plain; snap-on type	www.wago.com/793-4501/000-017
	Item no.: 793-4501/000-023 WMB marking card; as card; stretchable 4 - 4.2 mm; plain; snap-on type	www.wago.com/793-4501/000-023
	Item no.: 793-4501/000-024 WMB marking card; as card; stretchable 4 - 4.2 mm; plain; snap-on type	www.wago.com/793-4501/000-024

Protective Warning Marker



	Item no.: 279-405 Protective warning marker; with high-voltage symbol, black; for 5 terminal blocks	www.wago.com/279-405
--	---	--

Jumper



	Item no.: 249-123 Push-in type wire jumper; insulated; wire length 180 mm; Conductor cross section 0.75 mm ²	www.wago.com/249-123
	Item no.: 249-125 Push-in type wire jumper; insulated; wire length 60 mm; Conductor cross section 0.75 mm ²	www.wago.com/249-125
	Item no.: 249-126 Push-in type wire jumper; insulated; wire length 110 mm; Conductor cross section 0.75 mm ²	www.wago.com/249-126

	Item no.: 249-127 Push-in type wire jumper; insulated; wire length 250 mm; Conductor cross section 0.75 mm ²	www.wago.com/249-127
	Item no.: 279-402 Adjacent jumper; insulated; Nominal current 15 A	www.wago.com/279-402
	Item no.: 279-409 Alternate jumper; insulated; Nominal current 15 A	www.wago.com/279-409
	Item no.: 279-422 Adjacent jumper; insulated; Nominal current 15 A	www.wago.com/279-422
	Item no.: 284-414 Step-down jumper; insulated; from 10/6 mm ² to 4/2.5/1.5 mm ² ; Nominal current 15 A	www.wago.com/284-414

General accessories

	Item no.: 249-105 Group marker carrier	www.wago.com/249-105
	Item no.: 280-404 Test plug adapter; 5 mm wide; for test plug 210-137 (2.3 mm Ø); suitable for 1.5 mm ² - 4 mm ² tbs	www.wago.com/280-404

tools

	Item no.: 210-647 Operating tool with partially insulated shaft; Blade (2.5 x 0.4) mm; short	www.wago.com/210-647
	Item no.: 210-648 Operating tool with partially insulated shaft; Blade (2.5 x 0.4) mm; short; angled	www.wago.com/210-648
	Item no.: 210-719 Operating tool with partially insulated shaft; Type 1, blade (2.5 x 0.4) mm	www.wago.com/210-719

check

	Item no.: 209-170 Test plug adapter; 8.3 mm wide; for 4 mm Ø test plugs; suitable for 1.5 mm ² - 10 mm ² tbs	www.wago.com/209-170
--	--	--

Downloads

Documentation

Bid Text

279-101	Oct 11, 2017	DOC 24.6 kB	Download
---------	--------------	----------------	----------

smartDATA

CAD data

3D Download 279-101	URL	Download
---------------------	-----	----------



Subject to changes.

WAGO Kontakttechnik GmbH & Co. KG
Hansastr. 27
32423 Minden
Phone: +49571 887-0 | Fax: +49571 887-169
Email: info.de@wago.com | Web: www.wago.com

Do you have any questions about our products?
We are always happy to take your call at +49 (571) 887-44222.