

Data sheet | Item number: 2020-214

2-conductor female connector; 1.5 mm²; 14-pole

www.wago.com/2020-214

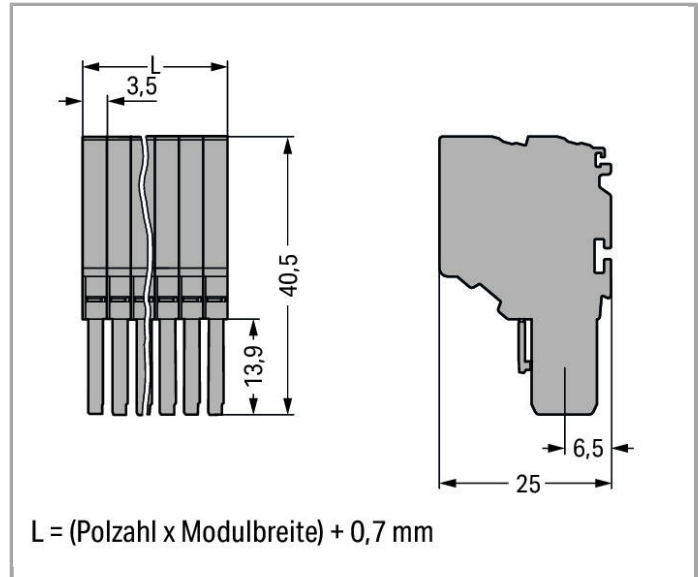
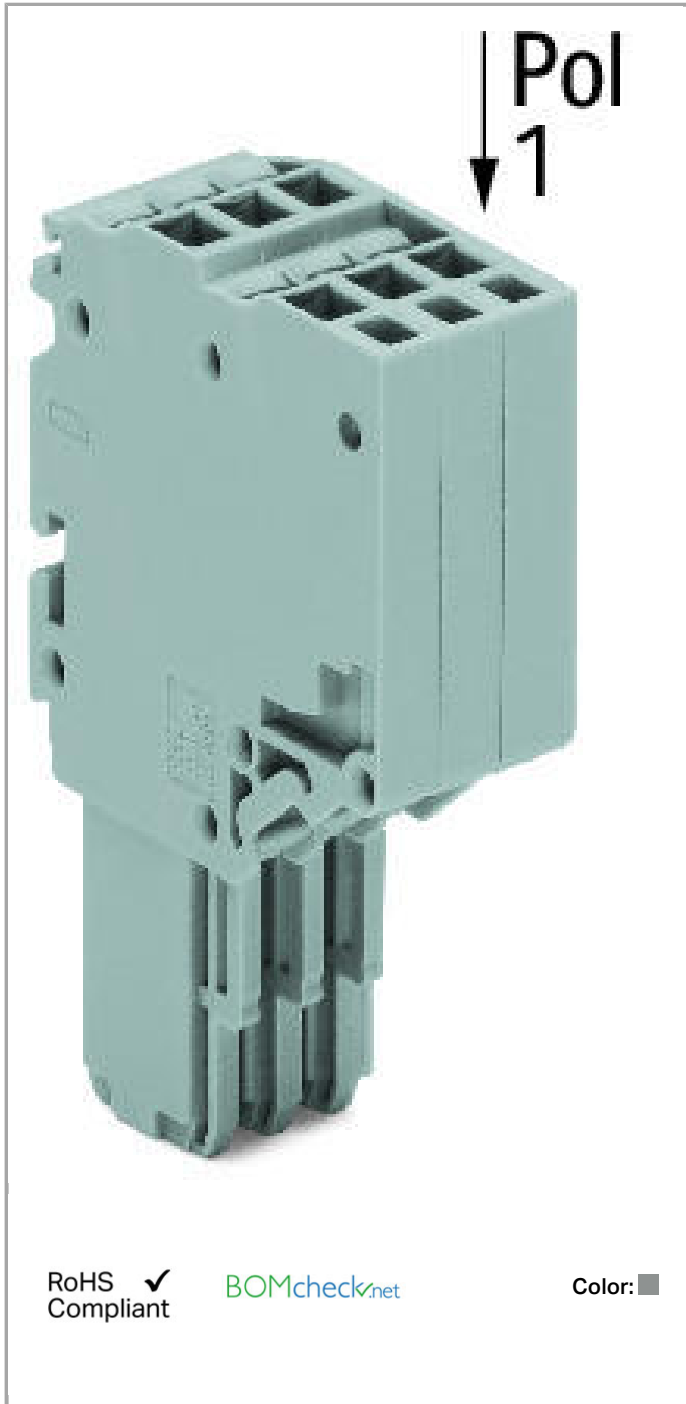

Item description

According to EN 61984, pluggable connectors without current interrupting capacity shall not be mated and unmated when live or under load.



Data

Electrical data

Ratings per IEC/EN 60664-1

Rated voltage (III / 3)	500 V
Rated impulse voltage (III / 3)	6 kV
Rated current	13.5 A
Legend (ratings)	(III / 3) $\hat{=}$ Overvoltage category III / Pollution degree 3

Approvals per UL 1059

Rated voltage UL (Use Group B)	300 V
Rated current UL (Use Group B)	15 A
Rated voltage UL (Use Group C)	300 V
Rated current UL (Use Group C)	15 A
Rated voltage UL (Use Group D)	300 V
Rated current UL (Use Group D)	15 A

Approvals per CSA

Rated voltage CSA (Use Group B)	300 V
Rated current CSA (Use Group B)	10 A
Rated voltage CSA (Use Group C)	300 V
Rated current CSA (Use Group C)	10 A

Connection data

Connection technology	Push-in CAGE CLAMP [®]
Actuation type	Operating tool Push-in
Connectable conductor materials	Copper Aluminum
Nominal cross section	1 mm ²
Solid conductor	0.14 ... 1.5 mm ² / 24 ... 16 AWG
Solid conductor, push-in termination	0.5 ... 1.5 mm ² / 20 ... 16 AWG
Fine-stranded conductor	0.14 ... 1.5 mm ² / 24 ... 16 AWG
Fine-stranded conductor with ferrule, push-in termination, from	0.5 mm ² / 20 AWG
Strip length	9 ... 11 mm / 0.35 ... 0.43 Inch
No. of poles	14
Total number of connection points	28
Total number of potentials	14
Type of wiring	Front-entry wiring

Geometrical Data

Width	49.7 mm / 1.957 inch
Height	40.5 mm / 1.594 inch
Depth	25 mm / 0.984 inch

Mechanical data

Marking level	Side marking
---------------	--------------

Plug connection

Contact type (pluggable connector)	Female connector/socket
Connector connection type	for conductors

Material Data

Color	gray
Insulating material	Polyamide 66 (PA 66)
Fire load	0.632 MJ
Weight	38.36 g

Commercial data



Country of origin	DE
GTIN	4045454855369
Customs Tariff No.	85366990990
Product Group	18 (X-COM-System)

Approvals / Certificates

Country specific Approvals

Logo	Approval	Certificate name
	CSA DEKRA Certification B.V.	2516073

Ship Approvals

Logo	Approval	Certificate name
	ABS American Bureau of Shipping	14-HG1293677-PDA
	BV Bureau Veritas S.A.	38586/A0 BV



LR
Lloyds Register

91/20112 (E9)

UL-Approvals

Logo	Approval	Certificate name
------	----------	------------------



UL
Underwriters Laboratories Inc.

E45172

Compatible products

ferrule



Item no.: 216-241

Ferrule; Sleeve for 0.5 mm² / AWG 22; insulated; electro-tin plated; electrolytic copper; gastight crimped; acc. to DIN 46228, Part 4/09.90

www.wago.com/216-241



Item no.: 216-242

Ferrule; Sleeve for 0.75 mm² / AWG 20; insulated; electro-tin plated; electrolytic copper; gastight crimped; acc. to DIN 46228, Part 4/09.90

www.wago.com/216-242



Item no.: 216-243

Ferrule; Sleeve for 1 mm² / AWG 18; insulated; electro-tin plated; electrolytic copper; gastight crimped; acc. to DIN 46228, Part 4/09.90

www.wago.com/216-243

Protective Warning Marker



Item no.: 2000-115

Protective warning marker; with high-voltage symbol, black; for 5 terminal blocks

www.wago.com/2000-115

Locking lever



Item no.: 2022-151

Locking lever; can be snapped on 1-conductor female plugs; 2 poles and more

www.wago.com/2022-151



Item no.: 2022-152

Locking lever; can be snapped on 1-conductor female plugs; 2 poles and more

www.wago.com/2022-152

Marking accessories



Item no.: 2009-113

WMB-Inline; for smartPRINTER; on reel; plain; snap-on type

www.wago.com/2009-113



Item no.: 2009-113/000-002

WMB-Inline; for smartPRINTER; on reel; plain; snap-on type







www.wago.com/2009-113/000-002





Item no.: 2009-113/000-005

WMB-Inline; for smartPRINTER; on reel; plain; snap-on type

www.wago.com/2009-113/000-005

	<p>Item no.: 2009-113/000-006 WMB-Inline; for smartPRINTER; on reel; plain; snap-on type</p>	www.wago.com/2009-113/000-006
	<p>Item no.: 2009-113/000-007 WMB-Inline; for smartPRINTER; on reel; plain; snap-on type</p>	www.wago.com/2009-113/000-007
	<p>Item no.: 2009-113/000-012 WMB-Inline; for smartPRINTER; on reel; plain; snap-on type</p>	www.wago.com/2009-113/000-012
	<p>Item no.: 2009-113/000-017 WMB-Inline; for smartPRINTER; on reel; plain; snap-on type</p>	www.wago.com/2009-113/000-017
	<p>Item no.: 2009-113/000-023 WMB-Inline; for smartPRINTER; on reel; plain; snap-on type</p>	www.wago.com/2009-113/000-023
	<p>Item no.: 2009-113/000-024 WMB-Inline; for smartPRINTER; on reel; plain; snap-on type</p>	www.wago.com/2009-113/000-024
	<p>Item no.: 793-3501 WMB marking card; as card; plain; snap-on type</p>	www.wago.com/793-3501

tools

	<p>Item no.: 210-647 Operating tool with partially insulated shaft; Blade (2.5 x 0.4) mm; short</p>	www.wago.com/210-647
	<p>Item no.: 210-648 Operating tool with partially insulated shaft; Blade (2.5 x 0.4) mm; short; angled</p>	www.wago.com/210-648
	<p>Item no.: 210-719 Operating tool with partially insulated shaft; Type 1, blade (2.5 x 0.4) mm</p>	www.wago.com/210-719

Strain relief plate

	<p>Item no.: 734-326 Strain relief plate</p>	www.wago.com/734-326
	<p>Item no.: 734-430 Strain relief plate</p>	www.wago.com/734-430
	<p>Item no.: 734-431 Strain relief plate</p>	www.wago.com/734-431

**Downloads
Documentation**

Bid Text

2020-214

Aug 14, 2018

DOCX

Download



15.5 kB

smartDATA

CAD data

3D Download 2020-214

URL

Download

Product family

X-COM S-Mini

[Show all products from the family](#)

Subject to changes.

WAGO Kontakttechnik GmbH & Co. KG

Hansastr. 27

32423 Minden

Phone: +49571 887-0 | Fax: +49571 887-169

Email: info.de@wago.com | Web: www.wago.com

Do you have any questions about our products?

We are always happy to take your call at +49 (571) 887-44222.