

Data sheet | Item number: 2020-112

1-conductor female plug; 1.5 mm²; 12-pole

www.wago.com/2020-112

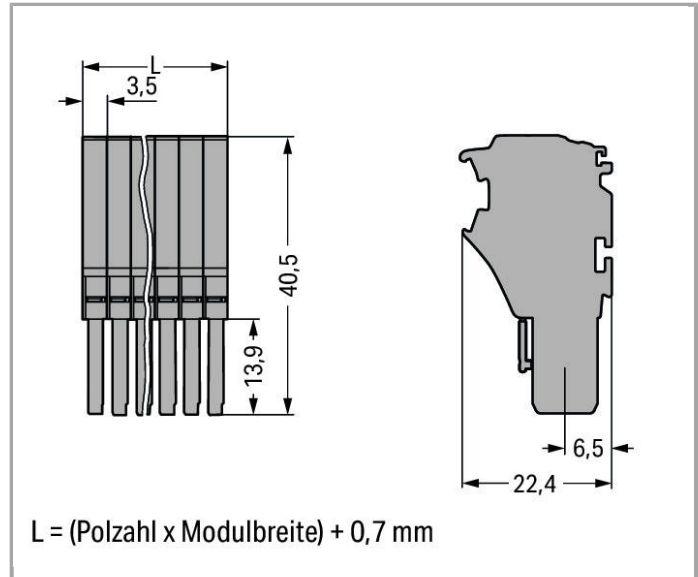
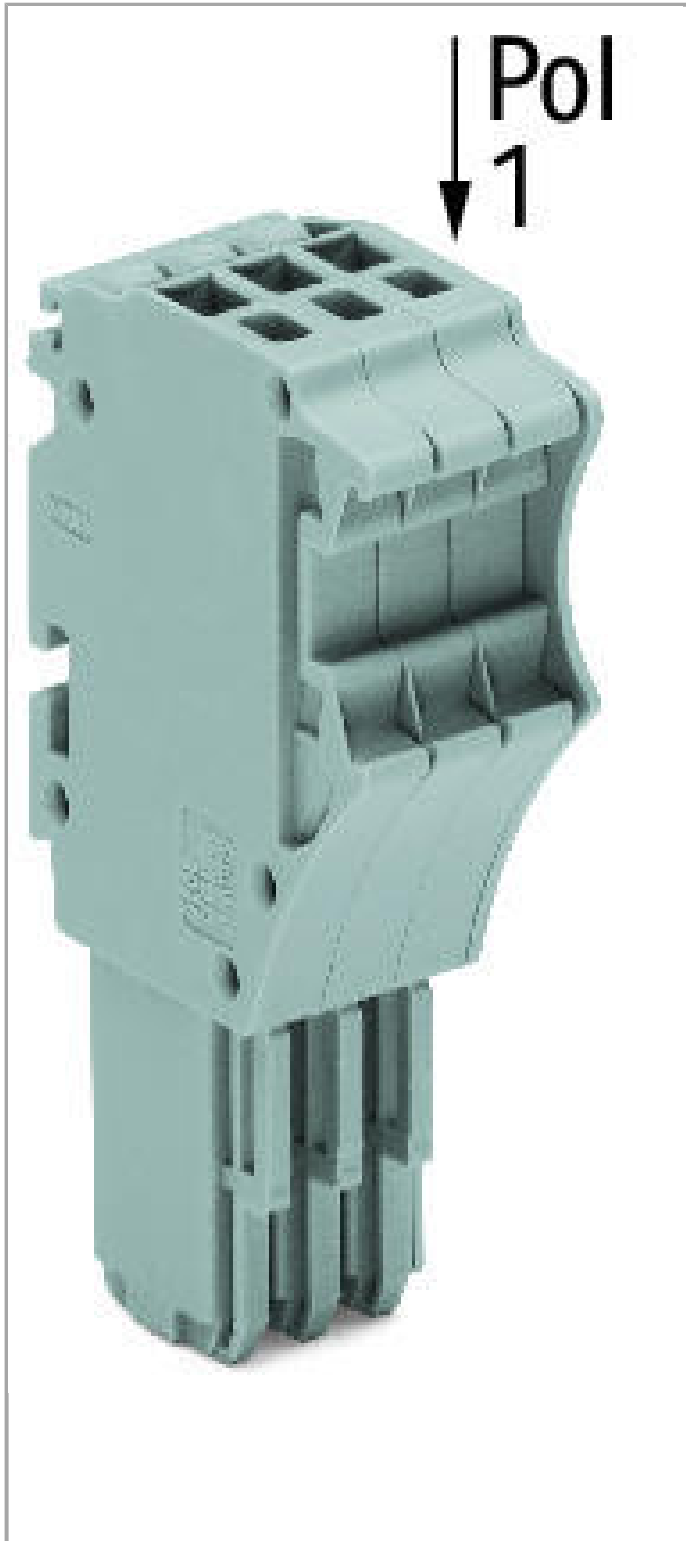

RoHS 
Compliant

BOMcheck.net

Color: 

Item description

According to EN 61984, pluggable connectors without current interrupting capacity shall not be mated and unmated when live or under load.

Data

Electrical data

Ratings per IEC/EN 60664-1

Rated voltage (III / 3)	500 V
Rated impulse voltage (III / 3)	6 kV
Rated current	13.5 A
Legend (ratings)	(III / 3) $\hat{=}$ Overvoltage category III / Pollution degree 3

Approvals per UL 1059

Rated voltage UL (Use Group B)	300 V
Rated current UL (Use Group B)	15 A
Rated voltage UL (Use Group C)	300 V
Rated current UL (Use Group C)	15 A
Rated voltage UL (Use Group D)	300 V
Rated current UL (Use Group D)	15 A

Approvals per CSA

Rated voltage CSA (Use Group B)	300 V
Rated current CSA (Use Group B)	10 A
Rated voltage CSA (Use Group C)	300 V
Rated current CSA (Use Group C)	10 A

Connection data

Connection technology	Push-in CAGE CLAMP [®]
Actuation type	Operating tool Push-in
Connectable conductor materials	Copper Aluminum
Nominal cross section	1 mm ²
Solid conductor	0.14 ... 1.5 mm ² / 24 ... 16 AWG

Solid conductor, push-in termination	0.5 ... 1.5 mm ² / 20 ... 16 AWG
Fine-stranded conductor	0.14 ... 1.5 mm ² / 24 ... 16 AWG
Fine-stranded conductor with ferrule, push-in termination, from	0.5 mm ² / 20 AWG
Strip length	9 ... 11 mm / 0.35 ... 0.43 Inch
No. of poles	12
Total number of connection points	12
Total number of potentials	12
Type of wiring	Front-entry wiring

Geometrical Data

Width	42.7 mm / 1.681 inch
Height	40.5 mm / 1.594 inch
Depth	22.4 mm / 0.882 inch

Mechanical data

Marking level	Side marking
---------------	--------------

Plug connection

Contact type (pluggable connector)	Female connector/socket
Connector connection type	for conductors

Material Data

Color	gray
Insulating material	Polyamide 66 (PA 66)
Fire load	0.481 MJ
Weight	27.11 g

Commercial data



Country of origin	CN
GTIN	4050821245100
Customs Tariff No.	85366990990

Approvals / Certificates

Country specific Approvals

Logo	Approval	Certificate name
	CSA DEKRA Certification B.V.	2516073

Ship Approvals



Logo	Approval	Certificate name
	ABS American Bureau of Shipping	14-HG1293677-PDA
	BV Bureau Veritas S.A.	38586/A0 BV

UL-Approvals

Logo	Approval	Certificate name
	UL Underwriters Laboratories Inc.	E45172

Compatible products





Strain relief plate

	Item no.: 734-326 Strain relief plate	www.wago.com/734-326
	Item no.: 734-327 Strain relief plate	www.wago.com/734-327
	Item no.: 734-329 Strain relief plate	www.wago.com/734-329

Protective Warning Marker

















	Item no.: 2000-115 Protective warning marker; with high-voltage symbol, black; for 5 terminal blocks	www.wago.com/2000-115
--	--	--

Locking lever

	Item no.: 2022-141 Locking lever; can be snapped on 1-conductor female plugs; for 1-pole female plugs	www.wago.com/2022-141
	Item no.: 2022-142 Locking lever; can be snapped on 1-conductor female plugs; for 1-pole female plugs	www.wago.com/2022-142
	Item no.: 2022-151 Locking lever; can be snapped on 1-conductor female plugs; 2 poles and more	www.wago.com/2022-151
	Item no.: 2022-152 Locking lever; can be snapped on 1-conductor female plugs; 2 poles and more	www.wago.com/2022-152

Marking accessories

	Item no.: 2009-110 Marking strips; on reel; not stretchable; plain; snap-on type	www.wago.com/2009-110
--	--	--

	Item no.: 2009-113 WMB-Inline; for smartPRINTER; on reel; plain; snap-on type	www.wago.com/2009-113
	Item no.: 2009-113/000-002 WMB-Inline; for smartPRINTER; on reel; plain; snap-on type	www.wago.com/2009-113/000-002
	Item no.: 2009-113/000-005 WMB-Inline; for smartPRINTER; on reel; plain; snap-on type	www.wago.com/2009-113/000-005
	Item no.: 2009-113/000-006 WMB-Inline; for smartPRINTER; on reel; plain; snap-on type	www.wago.com/2009-113/000-006
	Item no.: 2009-113/000-007 WMB-Inline; for smartPRINTER; on reel; plain; snap-on type	www.wago.com/2009-113/000-007
	Item no.: 2009-113/000-012 WMB-Inline; for smartPRINTER; on reel; plain; snap-on type	www.wago.com/2009-113/000-012
	Item no.: 2009-113/000-017 WMB-Inline; for smartPRINTER; on reel; plain; snap-on type	www.wago.com/2009-113/000-017
	Item no.: 2009-113/000-023 WMB-Inline; for smartPRINTER; on reel; plain; snap-on type	www.wago.com/2009-113/000-023
	Item no.: 2009-113/000-024 WMB-Inline; for smartPRINTER; on reel; plain; snap-on type	www.wago.com/2009-113/000-024
	Item no.: 210-831 Marking strips; on reel; 2.3 mm wide; plain; Self-adhesive	www.wago.com/210-831
	Item no.: 210-832 Marking strips; on reel; 3 mm wide; plain; Self-adhesive	www.wago.com/210-832
	Item no.: 210-833 Marking strips; on reel; 6 mm wide; plain; Self-adhesive	www.wago.com/210-833
	Item no.: 210-834 Marking strips; on reel; 5 mm wide; plain; Self-adhesive	www.wago.com/210-834
	Item no.: 793-3501 WMB marking card; as card; plain; snap-on type	www.wago.com/793-3501
ferrule		
	Item no.: 216-241 Ferrule; Sleeve for 0.5 mm ² / AWG 22; insulated; electro-tin plated; electrolytic copper; gastight crimped; acc. to DIN 46228, Part 4/09.90	www.wago.com/216-241
	Item no.: 216-242 Ferrule; Sleeve for 0.75 mm ² / AWG 20; insulated; electro-tin plated; electrolytic copper; gastight crimped; acc. to DIN 46228, Part 4/09.90	www.wago.com/216-242



Item no.: 216-243

Ferrule; Sleeve for 1 mm² / AWG 18; insulated; electro-tin plated; electrolytic copper; gastight crimped; acc. to DIN 46228, Part 4/09.90

www.wago.com/216-243

tools



Item no.: 210-647

Operating tool with partially insulated shaft; Blade (2.5 x 0.4) mm; short

www.wago.com/210-647



Item no.: 210-648

Operating tool with partially insulated shaft; Blade (2.5 x 0.4) mm; short; angled

www.wago.com/210-648



Item no.: 210-719

Operating tool with partially insulated shaft; Type 1, blade (2.5 x 0.4) mm

www.wago.com/210-719

Downloads

Documentation

Bid Text

2020-112	Aug 14, 2018	DOCX 15.4 kB	Download
----------	--------------	-----------------	----------

smartDATA

CAD data

3D Download 2020-112	URL	Download
----------------------	-----	----------

Product family

X-COM S-Mini

[Show all products from the family](#)

Subject to changes.