

Data sheet | Item number: 890-930

h-distribution connector; 5-pole; Cod. A; 1 input; 2 outputs; outputs on one side; 3 locking levers; for flying leads

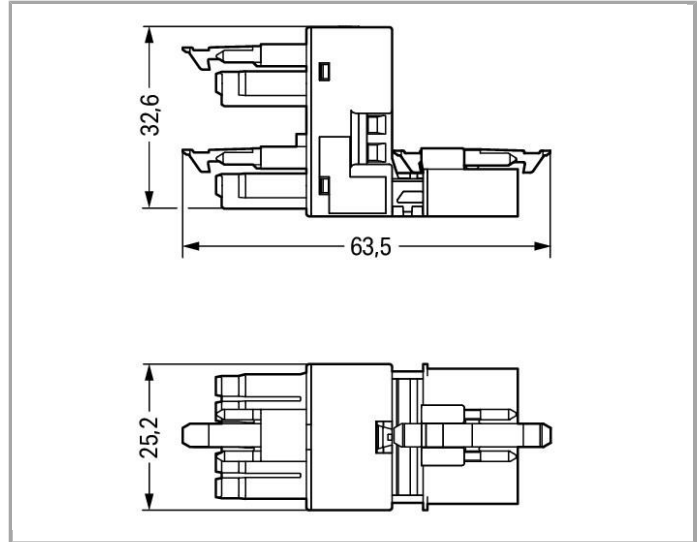

www.wago.com/890-930

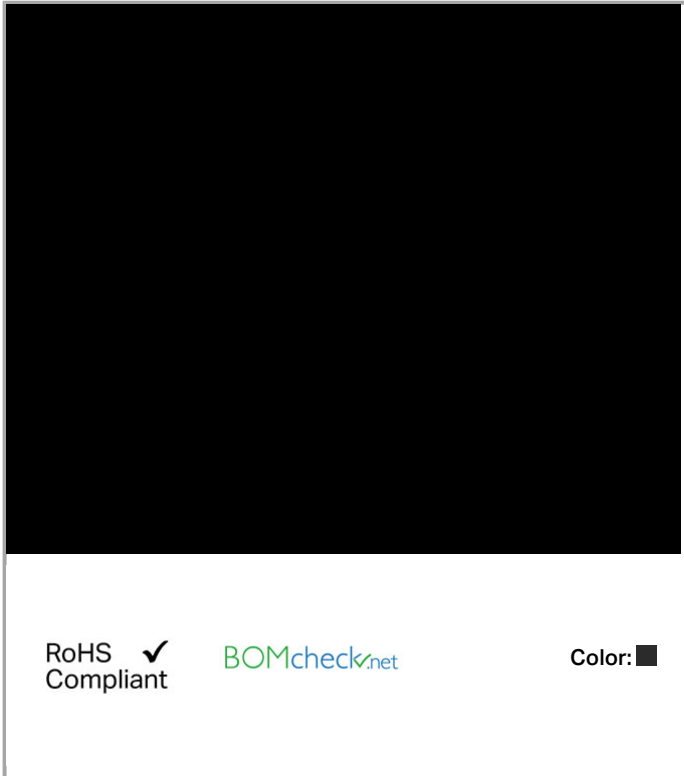

Item description

Note:

All connectors for mounted installations (snap-in versions for lighting fixtures or devices, all types of PCB and distribution connectors) are factory-equipped with locking levers to ensure plugs and sockets are securely locked. Additional locking levers are only required for flying leads (plug /socket).

Data

Electrical data

Ratings per IEC/EN 60664-1

Rated voltage (III / 3)	400 V
Rated impulse voltage (III / 3)	6 kV
Rated current	13 A
Legend (ratings)	(III / 3) ≙ Overvoltage category III / Pollution degree 3



Connection data

No. of poles	5
Total number of potentials	5

Geometrical Data

Pin spacing	4.4 mm (0.173 inch)
Width	25.2 mm / 0.992 inch
Height	32.65 mm / 1.285 inch
Depth	57.85 mm / 2.278 inch

Mechanical data

Coding	A
Mating force of a plug-in connection	approx. 20 ... 70 N (depending on pole number)
Retention force of a plug-in connection	when locked: > 80N
Unmating force of a plug-in connection	when unlocked: approx. 20 ... 70 N (depending on pole number)
Type of distribution connector	h-distribution connector, unidirectional
Marking	N 1 2 3
Degree of protection	IP20
Potential marking	N 1 2 3

Plug connection

Contact type (pluggable connector)	Socket/plug
Mismating protection	Yes
Locking of plug-in connection	locking lever
Locking lever	yes

Material Data

Color	black
Insulating material	Polyamide 66 (PA 66)
Flammability class per UL94	V0
Contact material	Copper or copper alloy, surface-treated
Fire load	0.369 MJ
Weight	23.373 g

Environmental Requirements

Surrounding air (operating) temperature	-35 ... 85 °C
---	---------------

Commercial data



Country of origin	DE
GTIN	4050821255123
Customs Tariff No.	85366990990
Product Group	20 (WINSTA)

Approvals / Certificates

Country specific Approvals

Logo	Approval	Certificate name
	CCA DEKRA Certification B.V.	2182129.01
	CCA DEKRA Certification B.V.	NL-35632

Ship Approvals



Logo	Approval	Certificate name
	ABS American Bureau of Shipping	14-HG1241513-PDA
	DNV GL Det Norske Veritas, Germanischer Lloyd	TAE00001Z6

UL-Approvals

Logo	Approval	Certificate name
	UL UL International Germany GmbH	E45171

Compatible products

assembling

	Item no.: 890-625 Mounting plate; for h-distribution connectors; 5-pole	www.wago.com/890-625
	Item no.: 890-675 Mounting plate; for h-distribution connectors; 5-pole	www.wago.com/890-675



Downloads

Documentation

Bid Text

890-930	Sep 19, 2016	DOC	Download
WINSTA MINI 5-polig		23.0 kB	

smartDATA

CAD data

3D Download 890-930	URL	Download
---------------------	-----	----------

Subject to changes.