

## Data sheet | Item number: 769-612/001-000

1-conductor male connector; Snap-in mounting feet; 4 mm<sup>2</sup>; Pin spacing 5 mm; 12-pole

[www.wago.com/769-612/001-000](http://www.wago.com/769-612/001-000)



RoHS  Compliant

BOMcheck.net

Color: ■

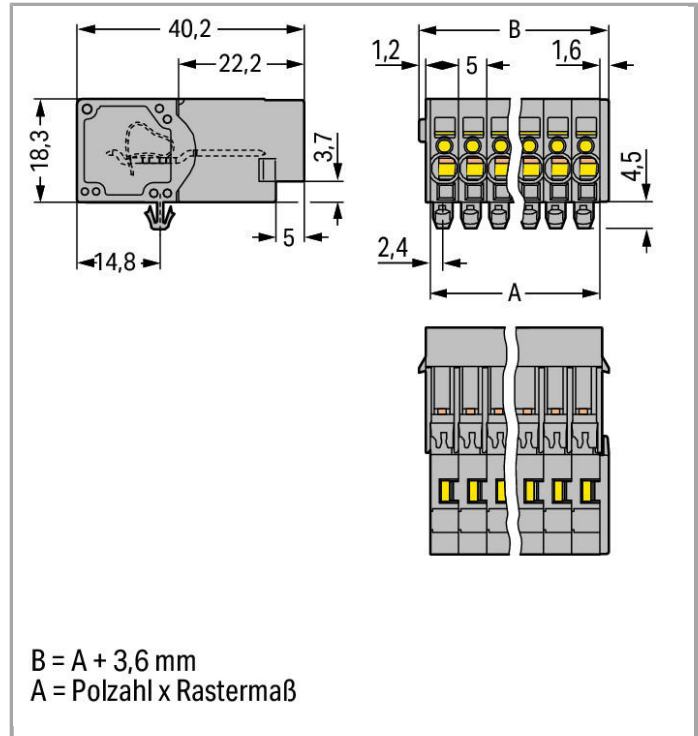

### Data

#### Electrical data

#### Ratings per IEC/EN 60664-1

Rated voltage (III / 3)	500 V
Rated impulse voltage (III / 3)	6 kV
Rated current	32 A
Legend (ratings)	(III / 3) ≙ Overvoltage category III / Pollution degree 3

#### Connection data

Connection technology	CAGE CLAMP®
Actuation type	Operating tool
Connectable conductor materials	Copper Aluminum
Nominal cross section	4 mm <sup>2</sup>
Solid conductor	0.08 ... 4 mm <sup>2</sup> / 28 ... 12 AWG
Fine-stranded conductor	0.08 ... 4 mm <sup>2</sup> / 28 ... 12 AWG



Strip length	8 ... 9 mm / 0.31 ... 0.35 Inch
No. of poles	12
Total number of connection points	12
Total number of potentials	12
Type of wiring	Front-entry wiring

### Geometrical Data

Pin spacing	5 mm / 0.197 inch
Width	63.6 mm / 2.504 inch
Height from the surface	18.3 mm / 0.72 inch
Depth	40.2 mm / 1.583 inch

### Mechanical data

Mounting type	Snap-in mounting foot
---------------	-----------------------

### Plug connection

Contact type (pluggable connector)	Male connector/plug
Connector connection type	for conductors

### Material Data

Color	gray
Insulating material	Polyamide 66 (PA 66)
Fire load	0.694 MJ
Weight	35.092 g

### Commercial data

Country of origin	PL
GTIN	4044918522151
Customs Tariff No.	85366990990
Product Group	18 (X-COM-System)

### Approvals / Certificates

#### Country specific Approvals

Logo	Approval	Certificate name
	CCA DEKRA Certification B.V.	NTR NL-7626
	CSA DEKRA Certification B.V.	1101144





KEMA/KEUR

2190419.01



DEKRA Certification B.V.

## UL-Approvals

Logo	Approval	Certificate name
	UR Underwriters Laboratories Inc.	E45172
	UR Underwriters Laboratories Inc.	E45171

## Compatible products



## Protective Warning Marker

	<b>Item no.: 280-415</b> Protective warning marker; with high-voltage symbol, black; for 5 terminal blocks	<a href="http://www.wago.com/280-415">www.wago.com/280-415</a>
--	---	--

## Strain relief plate

	<b>Item no.: 769-410</b> Strain relief plate	<a href="http://www.wago.com/769-410">www.wago.com/769-410</a>
	<b>Item no.: 769-414</b> Strain relief plate	<a href="http://www.wago.com/769-414">www.wago.com/769-414</a>

## Insulation stop

	<b>Item no.: 769-470</b> Insulation stop; 0.08 - 0.2 mm <sup>2</sup> "s" (0.14 mm <sup>2</sup> "f-st"); 5 pieces/strip	<a href="http://www.wago.com/769-470">www.wago.com/769-470</a>
	<b>Item no.: 769-471</b> Insulation stop; 0.25 - 0.5 mm <sup>2</sup> ; 5 pieces/strip	<a href="http://www.wago.com/769-471">www.wago.com/769-471</a>
	<b>Item no.: 769-472</b> Insulation stop; 0.75 - 1 mm <sup>2</sup> ; 5 pieces/strip	<a href="http://www.wago.com/769-472">www.wago.com/769-472</a>

## Female plug

	<b>Item no.: 769-101</b> 1-conductor female plug; 4 mm <sup>2</sup> ; 1-pole	<a href="http://www.wago.com/769-101">www.wago.com/769-101</a>
	<b>Item no.: 769-101/000-016</b> 1-conductor female plug; 4 mm <sup>2</sup> ; 1-pole	<a href="http://www.wago.com/769-101/000-016">www.wago.com/769-101/000-016</a>

**Item no.: 769-102**1-conductor female plug; 4 mm<sup>2</sup>; 2-pole[www.wago.com/769-102](http://www.wago.com/769-102)**Item no.: 769-102/000-036**1-conductor female plug; 4 mm<sup>2</sup>; 2-pole[www.wago.com/769-102/000-036](http://www.wago.com/769-102/000-036)**Item no.: 769-102/000-037**1-conductor female plug; 4 mm<sup>2</sup>; 2-pole[www.wago.com/769-102/000-037](http://www.wago.com/769-102/000-037)**Item no.: 769-103**1-conductor female plug; 4 mm<sup>2</sup>; 3-pole[www.wago.com/769-103](http://www.wago.com/769-103)**Item no.: 769-103/000-036**1-conductor female plug; 4 mm<sup>2</sup>; 3-pole[www.wago.com/769-103/000-036](http://www.wago.com/769-103/000-036)**Item no.: 769-103/000-037**1-conductor female plug; 4 mm<sup>2</sup>; 3-pole[www.wago.com/769-103/000-037](http://www.wago.com/769-103/000-037)**Item no.: 769-103/000-038**1-conductor female plug; 4 mm<sup>2</sup>; 3-pole[www.wago.com/769-103/000-038](http://www.wago.com/769-103/000-038)**Item no.: 769-103/000-039**1-conductor female plug; 4 mm<sup>2</sup>; 3-pole[www.wago.com/769-103/000-039](http://www.wago.com/769-103/000-039)**Item no.: 769-104**1-conductor female plug; 4 mm<sup>2</sup>; 4-pole[www.wago.com/769-104](http://www.wago.com/769-104)**Item no.: 769-104/000-036**1-conductor female plug; 4 mm<sup>2</sup>; 4-pole[www.wago.com/769-104/000-036](http://www.wago.com/769-104/000-036)**Item no.: 769-104/000-037**1-conductor female plug; 4 mm<sup>2</sup>; 4-pole[www.wago.com/769-104/000-037](http://www.wago.com/769-104/000-037)**Item no.: 769-104/000-038**1-conductor female plug; 4 mm<sup>2</sup>; 4-pole[www.wago.com/769-104/000-038](http://www.wago.com/769-104/000-038)**Item no.: 769-104/000-039**1-conductor female plug; 4 mm<sup>2</sup>; 4-pole[www.wago.com/769-104/000-039](http://www.wago.com/769-104/000-039)**Item no.: 769-105**1-conductor female plug; 4 mm<sup>2</sup>; 5-pole[www.wago.com/769-105](http://www.wago.com/769-105)**Item no.: 769-105/000-036**1-conductor female plug; 4 mm<sup>2</sup>; 5-pole[www.wago.com/769-105/000-036](http://www.wago.com/769-105/000-036)



**Item no.: 769-105/000-037**  
1-conductor female plug; 4 mm<sup>2</sup>; 5-pole

[www.wago.com/769-105/000-037](http://www.wago.com/769-105/000-037)



**Item no.: 769-105/000-038**  
1-conductor female plug; 4 mm<sup>2</sup>; 5-pole

[www.wago.com/769-105/000-038](http://www.wago.com/769-105/000-038)



**Item no.: 769-105/000-039**  
1-conductor female plug; 4 mm<sup>2</sup>; 5-pole

[www.wago.com/769-105/000-039](http://www.wago.com/769-105/000-039)

**Item no.: 769-106**  
1-conductor female plug; 4 mm<sup>2</sup>; 6-pole

[www.wago.com/769-106](http://www.wago.com/769-106)

**Item no.: 769-106/000-006**  
1-conductor female plug; 4 mm<sup>2</sup>; 6-pole

[www.wago.com/769-106/000-006](http://www.wago.com/769-106/000-006)



**Item no.: 769-106/000-036**  
1-conductor female plug; 4 mm<sup>2</sup>; 6-pole

[www.wago.com/769-106/000-036](http://www.wago.com/769-106/000-036)



**Item no.: 769-106/000-037**  
1-conductor female plug; 4 mm<sup>2</sup>; 6-pole

[www.wago.com/769-106/000-037](http://www.wago.com/769-106/000-037)



**Item no.: 769-106/000-038**  
1-conductor female plug; 4 mm<sup>2</sup>; 6-pole

[www.wago.com/769-106/000-038](http://www.wago.com/769-106/000-038)



**Item no.: 769-106/000-039**  
1-conductor female plug; 4 mm<sup>2</sup>; 6-pole

[www.wago.com/769-106/000-039](http://www.wago.com/769-106/000-039)

**Item no.: 769-107**  
1-conductor female plug; 4 mm<sup>2</sup>; 7-pole

[www.wago.com/769-107](http://www.wago.com/769-107)



**Item no.: 769-107/000-036**  
1-conductor female plug; 4 mm<sup>2</sup>; 7-pole

[www.wago.com/769-107/000-036](http://www.wago.com/769-107/000-036)



**Item no.: 769-107/000-037**  
1-conductor female plug; 4 mm<sup>2</sup>; 7-pole

[www.wago.com/769-107/000-037](http://www.wago.com/769-107/000-037)



**Item no.: 769-107/000-038**  
1-conductor female plug; 4 mm<sup>2</sup>; 7-pole

[www.wago.com/769-107/000-038](http://www.wago.com/769-107/000-038)













**Item no.: 769-107/000-039**  
1-conductor female plug; 4 mm<sup>2</sup>; 7-pole

[www.wago.com/769-107/000-039](http://www.wago.com/769-107/000-039)

**Item no.: 769-108**  
1-conductor female plug; 4 mm<sup>2</sup>; 8-pole

[www.wago.com/769-108](http://www.wago.com/769-108)

	<b>Item no.: 769-108/000-036</b> 1-conductor female plug; 4 mm <sup>2</sup> ; 8-pole	<a href="http://www.wago.com/769-108/000-036">www.wago.com/769-108/000-036</a>
	<b>Item no.: 769-108/000-037</b> 1-conductor female plug; 4 mm <sup>2</sup> ; 8-pole	<a href="http://www.wago.com/769-108/000-037">www.wago.com/769-108/000-037</a>
	<b>Item no.: 769-108/000-038</b> 1-conductor female plug; 4 mm <sup>2</sup> ; 8-pole	<a href="http://www.wago.com/769-108/000-038">www.wago.com/769-108/000-038</a>
	<b>Item no.: 769-108/000-039</b> 1-conductor female plug; 4 mm <sup>2</sup> ; 8-pole	<a href="http://www.wago.com/769-108/000-039">www.wago.com/769-108/000-039</a>
	<b>Item no.: 769-109</b> 1-conductor female plug; 4 mm <sup>2</sup> ; 9-pole	<a href="http://www.wago.com/769-109">www.wago.com/769-109</a>
	<b>Item no.: 769-109/000-036</b> 1-conductor female plug; 4 mm <sup>2</sup> ; 9-pole	<a href="http://www.wago.com/769-109/000-036">www.wago.com/769-109/000-036</a>
	<b>Item no.: 769-109/000-037</b> 1-conductor female plug; 4 mm <sup>2</sup> ; 9-pole	<a href="http://www.wago.com/769-109/000-037">www.wago.com/769-109/000-037</a>
	<b>Item no.: 769-109/000-038</b> 1-conductor female plug; 4 mm <sup>2</sup> ; 9-pole	<a href="http://www.wago.com/769-109/000-038">www.wago.com/769-109/000-038</a>
	<b>Item no.: 769-109/000-039</b> 1-conductor female plug; 4 mm <sup>2</sup> ; 9-pole	<a href="http://www.wago.com/769-109/000-039">www.wago.com/769-109/000-039</a>
	<b>Item no.: 769-110</b> 1-conductor female plug; 4 mm <sup>2</sup> ; 10-pole	<a href="http://www.wago.com/769-110">www.wago.com/769-110</a>
	<b>Item no.: 769-110/000-036</b> 1-conductor female plug; 4 mm <sup>2</sup> ; 10-pole	<a href="http://www.wago.com/769-110/000-036">www.wago.com/769-110/000-036</a>
	<b>Item no.: 769-110/000-037</b> 1-conductor female plug; 4 mm <sup>2</sup> ; 10-pole	<a href="http://www.wago.com/769-110/000-037">www.wago.com/769-110/000-037</a>
	<b>Item no.: 769-110/000-038</b> 1-conductor female plug; 4 mm <sup>2</sup> ; 10-pole	<a href="http://www.wago.com/769-110/000-038">www.wago.com/769-110/000-038</a>
	<b>Item no.: 769-110/000-039</b> 1-conductor female plug; 4 mm <sup>2</sup> ; 10-pole	<a href="http://www.wago.com/769-110/000-039">www.wago.com/769-110/000-039</a>
	<b>Item no.: 769-111</b> 1-conductor female plug; 4 mm <sup>2</sup> ; 11-pole	<a href="http://www.wago.com/769-111">www.wago.com/769-111</a>

	<b>Item no.: 769-111/000-036</b> 1-conductor female plug; 4 mm <sup>2</sup> ; 11-pole	<a href="http://www.wago.com/769-111/000-036">www.wago.com/769-111/000-036</a>
	<b>Item no.: 769-111/000-037</b> 1-conductor female plug; 4 mm <sup>2</sup> ; 11-pole	<a href="http://www.wago.com/769-111/000-037">www.wago.com/769-111/000-037</a>
	<b>Item no.: 769-111/000-038</b> 1-conductor female plug; 4 mm <sup>2</sup> ; 11-pole	<a href="http://www.wago.com/769-111/000-038">www.wago.com/769-111/000-038</a>
	<b>Item no.: 769-111/000-039</b> 1-conductor female plug; 4 mm <sup>2</sup> ; 11-pole	<a href="http://www.wago.com/769-111/000-039">www.wago.com/769-111/000-039</a>
	<b>Item no.: 769-112</b> 1-conductor female plug; 4 mm <sup>2</sup> ; 12-pole	<a href="http://www.wago.com/769-112">www.wago.com/769-112</a>
	<b>Item no.: 769-112/000-036</b> 1-conductor female plug; 4 mm <sup>2</sup> ; 12-pole	<a href="http://www.wago.com/769-112/000-036">www.wago.com/769-112/000-036</a>
	<b>Item no.: 769-112/000-037</b> 1-conductor female plug; 4 mm <sup>2</sup> ; 12-pole	<a href="http://www.wago.com/769-112/000-037">www.wago.com/769-112/000-037</a>
	<b>Item no.: 769-112/000-038</b> 1-conductor female plug; 4 mm <sup>2</sup> ; 12-pole	<a href="http://www.wago.com/769-112/000-038">www.wago.com/769-112/000-038</a>
	<b>Item no.: 769-112/000-039</b> 1-conductor female plug; 4 mm <sup>2</sup> ; 12-pole	<a href="http://www.wago.com/769-112/000-039">www.wago.com/769-112/000-039</a>
	<b>Item no.: 769-112/021-000</b> 1-conductor female plug; Locking lever; 4 mm <sup>2</sup> ; 12-pole	<a href="http://www.wago.com/769-112/021-000">www.wago.com/769-112/021-000</a>
	<b>Item no.: 769-121</b> 2-conductor female connector; 4 mm <sup>2</sup> ; 1-pole	<a href="http://www.wago.com/769-121">www.wago.com/769-121</a>
	<b>Item no.: 769-122</b> 2-conductor female connector; 4 mm <sup>2</sup> ; 2-pole	<a href="http://www.wago.com/769-122">www.wago.com/769-122</a>
	<b>Item no.: 769-123</b> 2-conductor female connector; 4 mm <sup>2</sup> ; 3-pole	<a href="http://www.wago.com/769-123">www.wago.com/769-123</a>
	<b>Item no.: 769-124</b> 2-conductor female connector; 4 mm <sup>2</sup> ; 4-pole	<a href="http://www.wago.com/769-124">www.wago.com/769-124</a>
	<b>Item no.: 769-125</b> 2-conductor female connector; 4 mm <sup>2</sup> ; 5-pole	<a href="http://www.wago.com/769-125">www.wago.com/769-125</a>
	<b>Item no.: 769-126</b> 2-conductor female connector; 4 mm <sup>2</sup> ; 6-pole	<a href="http://www.wago.com/769-126">www.wago.com/769-126</a>
	<b>Item no.: 769-127</b> 2-conductor female connector; 4 mm <sup>2</sup> ; 7-pole	<a href="http://www.wago.com/769-127">www.wago.com/769-127</a>

<b>Item no.: 769-128</b> 2-conductor female connector; 4 mm <sup>2</sup> ; 8-pole	<a href="http://www.wago.com/769-128">www.wago.com/769-128</a>
--	--

<b>Item no.: 769-129</b> 2-conductor female connector; 4 mm <sup>2</sup> ; 9-pole	<a href="http://www.wago.com/769-129">www.wago.com/769-129</a>
--	--

<b>Item no.: 769-130</b> 2-conductor female connector; 4 mm <sup>2</sup> ; 10-pole	<a href="http://www.wago.com/769-130">www.wago.com/769-130</a>
---	--

<b>Item no.: 769-131</b> 2-conductor female connector; 4 mm <sup>2</sup> ; 11-pole	<a href="http://www.wago.com/769-131">www.wago.com/769-131</a>
---	--

<b>Item no.: 769-132</b> 2-conductor female connector; 4 mm <sup>2</sup> ; 12-pole	<a href="http://www.wago.com/769-132">www.wago.com/769-132</a>
---	--

#### assembling



<b>Item no.: 209-137</b> Mounting adapter; can be used as end plate; 6.5 mm wide	<a href="http://www.wago.com/209-137">www.wago.com/209-137</a>
---	--

#### ferrule



<b>Item no.: 216-101</b> Ferrule; Sleeve for 0.5 mm <sup>2</sup> / AWG 22; uninsulated; electro-tin plated	<a href="http://www.wago.com/216-101">www.wago.com/216-101</a>
---	--



<b>Item no.: 216-102</b> Ferrule; Sleeve for 0.75 mm <sup>2</sup> / AWG 20; uninsulated; electro-tin plated	<a href="http://www.wago.com/216-102">www.wago.com/216-102</a>
--	--



<b>Item no.: 216-103</b> Ferrule; Sleeve for 1 mm <sup>2</sup> / AWG 18; uninsulated; electro-tin plated	<a href="http://www.wago.com/216-103">www.wago.com/216-103</a>
---	--



<b>Item no.: 216-104</b> Ferrule; Sleeve for 1.5 mm <sup>2</sup> / AWG 16; uninsulated; electro-tin plated	<a href="http://www.wago.com/216-104">www.wago.com/216-104</a>
---	--



<b>Item no.: 216-201</b> Ferrule; Sleeve for 0.5 mm <sup>2</sup> / AWG 22; insulated; electro-tin plated	<a href="http://www.wago.com/216-201">www.wago.com/216-201</a>
---	--



<b>Item no.: 216-202</b> Ferrule; Sleeve for 0.75 mm <sup>2</sup> / AWG 20; insulated; electro-tin plated	<a href="http://www.wago.com/216-202">www.wago.com/216-202</a>
--	--



<b>Item no.: 216-203</b> Ferrule; Sleeve for 1 mm <sup>2</sup> / AWG 18; insulated; electro-tin plated	<a href="http://www.wago.com/216-203">www.wago.com/216-203</a>
---	--



<b>Item no.: 216-204</b> Ferrule; Sleeve for 1.5 mm <sup>2</sup> / AWG 16; insulated; electro-tin plated	<a href="http://www.wago.com/216-204">www.wago.com/216-204</a>
---	--



<b>Item no.: 216-206</b> Ferrule; Sleeve for 2.5 mm <sup>2</sup> / AWG 14; insulated; electro-tin plated	<a href="http://www.wago.com/216-206">www.wago.com/216-206</a>
---	--

















#### Coding



<b>Item no.: 769-435</b> Coding pin; for coding of female plugs; for carrier terminal blocks / male connectors	<a href="http://www.wago.com/769-435">www.wago.com/769-435</a>
---	--

#### Marking accessories



	<b>Item no.: 2009-145</b> Mini-WSB Inline; for smartPRINTER; on reel; stretchable 5 - 5.2 mm; plain; snap-on type	<a href="http://www.wago.com/2009-145">www.wago.com/2009-145</a>
	<b>Item no.: 2009-145/000-002</b> Mini-WSB Inline; for smartPRINTER; on reel; stretchable 5 - 5.2 mm; plain; snap-on type	<a href="http://www.wago.com/2009-145/000-002">www.wago.com/2009-145/000-002</a>
	<b>Item no.: 2009-145/000-005</b> Mini-WSB Inline; for smartPRINTER; on reel; stretchable 5 - 5.2 mm; plain; snap-on type	<a href="http://www.wago.com/2009-145/000-005">www.wago.com/2009-145/000-005</a>
	<b>Item no.: 2009-145/000-006</b> Mini-WSB Inline; for smartPRINTER; on reel; stretchable 5 - 5.2 mm; plain; snap-on type	<a href="http://www.wago.com/2009-145/000-006">www.wago.com/2009-145/000-006</a>
	<b>Item no.: 2009-145/000-007</b> Mini-WSB Inline; for smartPRINTER; on reel; stretchable 5 - 5.2 mm; plain; snap-on type	<a href="http://www.wago.com/2009-145/000-007">www.wago.com/2009-145/000-007</a>
	<b>Item no.: 2009-145/000-012</b> Mini-WSB Inline; for smartPRINTER; on reel; stretchable 5 - 5.2 mm; plain; snap-on type	<a href="http://www.wago.com/2009-145/000-012">www.wago.com/2009-145/000-012</a>
	<b>Item no.: 2009-145/000-023</b> Mini-WSB Inline; for smartPRINTER; on reel; stretchable 5 - 5.2 mm; plain; snap-on type	<a href="http://www.wago.com/2009-145/000-023">www.wago.com/2009-145/000-023</a>
	<b>Item no.: 2009-145/000-024</b> Mini-WSB Inline; on reel; stretchable 5 - 5.2 mm; plain; snap-on type	<a href="http://www.wago.com/2009-145/000-024">www.wago.com/2009-145/000-024</a>
	<b>Item no.: 210-831</b> Marking strips; on reel; 2.3 mm wide; plain; Self-adhesive	<a href="http://www.wago.com/210-831">www.wago.com/210-831</a>
	<b>Item no.: 210-832</b> Marking strips; on reel; 3 mm wide; plain; Self-adhesive	<a href="http://www.wago.com/210-832">www.wago.com/210-832</a>
	<b>Item no.: 210-833</b> Marking strips; on reel; 6 mm wide; plain; Self-adhesive	<a href="http://www.wago.com/210-833">www.wago.com/210-833</a>
	<b>Item no.: 210-834</b> Marking strips; on reel; 5 mm wide; plain; Self-adhesive	<a href="http://www.wago.com/210-834">www.wago.com/210-834</a>
	<b>Item no.: 248-501</b> Miniature WSB Quick marking system; plain; Marker width 5 mm; 10 strips with 10 markers per card	<a href="http://www.wago.com/248-501">www.wago.com/248-501</a>
	<b>Item no.: 248-501/000-002</b> Mini-WSB marking card; as card; not stretchable; plain; snap-on type	<a href="http://www.wago.com/248-501/000-002">www.wago.com/248-501/000-002</a>
	<b>Item no.: 248-501/000-005</b> Mini-WSB marking card; as card; plain; snap-on type	<a href="http://www.wago.com/248-501/000-005">www.wago.com/248-501/000-005</a>
	<b>Item no.: 248-501/000-006</b> Mini-WSB marking card; as card; not stretchable; plain; snap-on type	<a href="http://www.wago.com/248-501/000-006">www.wago.com/248-501/000-006</a>



**Item no.: 248-501/000-007**  
Mini-WSB marking card; as card; not stretchable; plain; snap-on type

[www.wago.com/248-501/000-007](http://www.wago.com/248-501/000-007)



**Item no.: 248-501/000-012**  
Mini-WSB marking card; as card; not stretchable; plain; snap-on type

[www.wago.com/248-501/000-012](http://www.wago.com/248-501/000-012)



**Item no.: 248-501/000-017**  
Mini-WSB marking card; as card; not stretchable; plain; snap-on type

[www.wago.com/248-501/000-017](http://www.wago.com/248-501/000-017)



**Item no.: 248-501/000-023**  
Mini-WSB marking card; as card; not stretchable; plain; snap-on type

[www.wago.com/248-501/000-023](http://www.wago.com/248-501/000-023)



**Item no.: 248-501/000-024**  
Mini-WSB marking card; as card; not stretchable; plain; snap-on type

[www.wago.com/248-501/000-024](http://www.wago.com/248-501/000-024)

#### tools



**Item no.: 210-490**  
Operating tool; for female and male connectors with CAGE CLAMP® connection

[www.wago.com/210-490](http://www.wago.com/210-490)



**Item no.: 769-434**  
Push-button; loose; for female and male connectors with CAGE CLAMP® connection

[www.wago.com/769-434](http://www.wago.com/769-434)

#### Downloads

##### Documentation

##### Bid Text

769-612/001-000	Oct 18, 2017	DOC 25.6 kB	Download
-----------------	--------------	----------------	----------

#### smartDATA

##### CAD data

3D Download 769-612/001-000	URL	Download
-----------------------------	-----	----------

#### Product family

##### X-COM

[Learn more about the product family.](#)

[Show all products from the family](#)



Subject to changes.

---

WAGO Kontakttechnik GmbH & Co. KG

Hansastr. 27

32423 Minden

Phone: +49571 887-0 | Fax: +49571 887-169

Email: [info.de@wago.com](mailto:info.de@wago.com) | Web: [www.wago.com](http://www.wago.com)

Do you have any questions about our products?

We are always happy to take your call at +49 (571) 887-44222.