

Data sheet | Item number: 2002-1872/401-000

4-conductor disconnect/test terminal block; with mechanical interlock; with test option; orange disconnect link; for DIN-rail 35 x 15 and 35 x 7.5; 2.5 mm²; Push-in CAGE CLAMP®

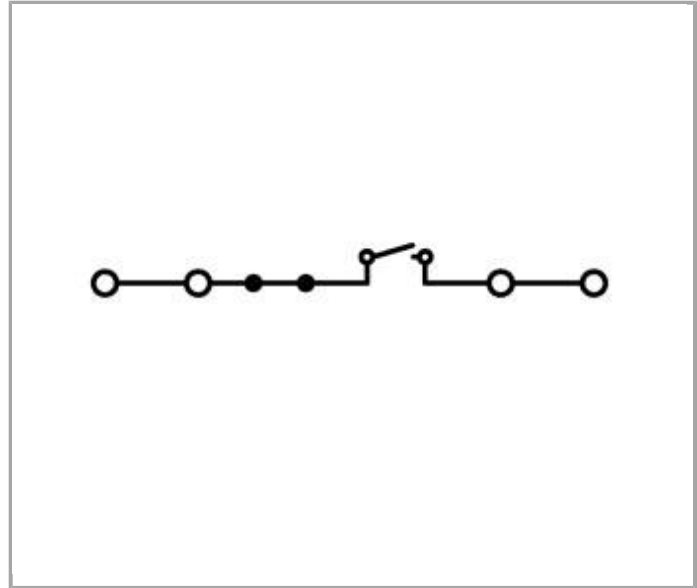

www.wago.com/2002-1872/401-000

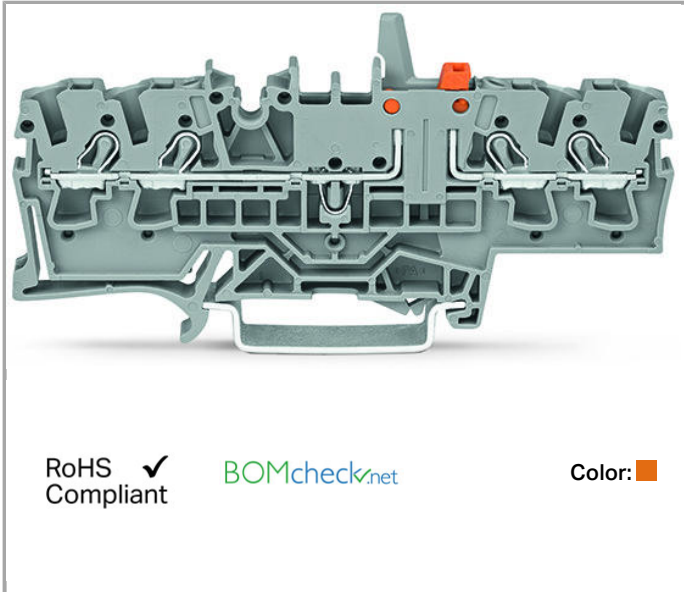

Data

Electrical data

Ratings per IEC/EN 60664-1

Rated voltage (III / 3)	400 V
Rated impulse voltage (III / 3)	6 kV
Rated current	16 A
Legend (ratings)	(III / 3) ≙ Overvoltage category III / Pollution degree 3

Approvals per UL 1059

Rated voltage UL (Use Group B)	300 V
Rated current UL (Use Group B)	15 A
Rated voltage UL (Use Group C)	300 V
Rated current UL (Use Group C)	15 A

Connection data

Connection technology	Push-in CAGE CLAMP®
Actuation type	Push-in Operating tool
Connectable conductor materials	Copper
Nominal cross section	2.5 mm ²



Solid conductor	0.25 ... 4 mm ² / 22 ... 12 AWG
Solid conductor, push-in termination	0.75 ... 4 mm ² / 18 ... 12 AWG
Fine-stranded conductor	0.25 ... 4 mm ² / 22 ... 12 AWG
Fine-stranded conductor with ferrule, push-in termination, from	0.75 mm ² / 18 AWG
Strip length	10 ... 12 mm / 0.39 ... 0.47 Inch
Total number of connection points	4
Total number of potentials	2
Number of levels	1
Type of wiring	Front-entry wiring

Geometrical Data

Width	5.2 mm / 0.205 inch
Height from upper-edge of DIN-35 rail	32.9 mm / 1.295 inch
Depth	87.5 mm / 3.445 inch

Mechanical data

Design	horizontal
Type of mounting	DIN-35 rail
Marking level	Center/side marking

Material Data

Color	orange
Insulating material	Polyamide 66 (PA 66)
Fire load	0.2 MJ
Weight	9.95 g

Commercial data

Country of origin	CN
GTIN	4045454826161
Customs Tariff No.	85365080990
Product Group	22 (TOPJOB S)

Approvals / Certificates



Ex-Approvals

Logo	Approval	Certificate name
	IECEX KIWA Netherlands B.V.	IECEX KIWA 17.0014U

Country specific Approvals

Logo	Approval	Certificate name
	CCA DEKRA Certification B.V.	NTR NL 7585
	CSA DEKRA Certification B.V.	1536069
	CSA DEKRA Certification B.V.	1536069
	KEMA/KEUR DEKRA Certification B.V.	2198985.01

Ship Approvals



Logo	Approval	Certificate name
	ABS American Bureau of Shipping	14-HG1293677-PDA
	DNV GL Det Norske Veritas, Germanischer Lloyd	TAE00001V2















UL-Approvals

















Logo	Approval	Certificate name
	UR Underwriters Laboratories Inc.	E45172

Compatible products

Marking accessories

	Item no.: 2002-161 Adaptor	www.wago.com/2002-161
	Item no.: 2009-110 Marking strips; on reel; not stretchable; plain; snap-on type	www.wago.com/2009-110
	Item no.: 2009-115 WMB-Inline; for smartPRINTER; on reel; stretchable 5 - 5.2 mm; plain; snap-on type	www.wago.com/2009-115

	<p>Item no.: 2009-115/000-002 WMB-Inline; for smartPRINTER; on reel; stretchable 5 - 5.2 mm; plain; snap-on type</p>	<p>www.wago.com/2009-115/000-002</p>
	<p>Item no.: 2009-115/000-006 WMB-Inline; for smartPRINTER; on reel; stretchable 5 - 5.2 mm; plain; snap-on type</p>	<p>www.wago.com/2009-115/000-006</p>
	<p>Item no.: 2009-115/000-007 WMB-Inline; for smartPRINTER; on reel; stretchable 5 - 5.2 mm; plain; snap-on type</p>	<p>www.wago.com/2009-115/000-007</p>
	<p>Item no.: 2009-115/000-012 WMB-Inline; for smartPRINTER; on reel; stretchable 5 - 5.2 mm; plain; snap-on type</p>	<p>www.wago.com/2009-115/000-012</p>
	<p>Item no.: 2009-115/000-017 WMB-Inline; for smartPRINTER; on reel; stretchable 5 - 5.2 mm; plain; snap-on type</p>	<p>www.wago.com/2009-115/000-017</p>
	<p>Item no.: 2009-115/000-023 WMB-Inline; for smartPRINTER; on reel; stretchable 5 - 5.2 mm; plain; snap-on type</p>	<p>www.wago.com/2009-115/000-023</p>
	<p>Item no.: 2009-115/000-024 WMB-Inline; for smartPRINTER; on reel; stretchable 5 - 5.2 mm; plain; snap-on type</p>	<p>www.wago.com/2009-115/000-024</p>
	<p>Item no.: 2009-145 Mini-WSB Inline; for smartPRINTER; on reel; stretchable 5 - 5.2 mm; plain; snap-on type</p>	<p>www.wago.com/2009-145</p>
	<p>Item no.: 2009-145/000-002 Mini-WSB Inline; for smartPRINTER; on reel; stretchable 5 - 5.2 mm; plain; snap-on type</p>	<p>www.wago.com/2009-145/000-002</p>
	<p>Item no.: 2009-145/000-005 Mini-WSB Inline; for smartPRINTER; on reel; stretchable 5 - 5.2 mm; plain; snap-on type</p>	<p>www.wago.com/2009-145/000-005</p>
	<p>Item no.: 2009-145/000-006 Mini-WSB Inline; for smartPRINTER; on reel; stretchable 5 - 5.2 mm; plain; snap-on type</p>	<p>www.wago.com/2009-145/000-006</p>
	<p>Item no.: 2009-145/000-007 Mini-WSB Inline; for smartPRINTER; on reel; stretchable 5 - 5.2 mm; plain; snap-on type</p>	<p>www.wago.com/2009-145/000-007</p>
	<p>Item no.: 2009-145/000-012 Mini-WSB Inline; for smartPRINTER; on reel; stretchable 5 - 5.2 mm; plain; snap-on type</p>	<p>www.wago.com/2009-145/000-012</p>
	<p>Item no.: 2009-145/000-023 Mini-WSB Inline; for smartPRINTER; on reel; stretchable 5 - 5.2 mm; plain; snap-on type</p>	<p>www.wago.com/2009-145/000-023</p>
	<p>Item no.: 2009-145/000-024 Mini-WSB Inline; on reel; stretchable 5 - 5.2 mm; plain; snap-on type</p>	<p>www.wago.com/2009-145/000-024</p>

	Item no.: 2009-191 Group marker carrier	www.wago.com/2009-191
	Item no.: 2009-192 Group marker carrier	www.wago.com/2009-192
	Item no.: 2009-193 Group marker carrier	www.wago.com/2009-193
	Item no.: 2009-198 Adaptor	www.wago.com/2009-198
	Item no.: 248-501 Miniature WSB Quick marking system; plain; Marker width 5 mm; 10 strips with 10 markers per card	www.wago.com/248-501
	Item no.: 248-501/000-002 Mini-WSB marking card; as card; not stretchable; plain; snap-on type	www.wago.com/248-501/000-002
	Item no.: 248-501/000-005 Mini-WSB marking card; as card; plain; snap-on type	www.wago.com/248-501/000-005
	Item no.: 248-501/000-006 Mini-WSB marking card; as card; not stretchable; plain; snap-on type	www.wago.com/248-501/000-006
	Item no.: 248-501/000-007 Mini-WSB marking card; as card; not stretchable; plain; snap-on type	www.wago.com/248-501/000-007
	Item no.: 248-501/000-012 Mini-WSB marking card; as card; not stretchable; plain; snap-on type	www.wago.com/248-501/000-012
	Item no.: 248-501/000-017 Mini-WSB marking card; as card; not stretchable; plain; snap-on type	www.wago.com/248-501/000-017
	Item no.: 248-501/000-023 Mini-WSB marking card; as card; not stretchable; plain; snap-on type	www.wago.com/248-501/000-023
	Item no.: 248-501/000-024 Mini-WSB marking card; as card; not stretchable; plain; snap-on type	www.wago.com/248-501/000-024
	Item no.: 793-501 WMB marking card; as card; not stretchable; plain; snap-on type	www.wago.com/793-501
	Item no.: 793-501/000-002 WMB marking card; as card; not stretchable; plain; snap-on type	www.wago.com/793-501/000-002
	Item no.: 793-501/000-005 WMB marking card; as card; not stretchable; plain; snap-on type	www.wago.com/793-501/000-005



Item no.: 793-501/000-006
WMB marking card; as card; not stretchable; plain; snap-on type

www.wago.com/793-501/000-006



Item no.: 793-501/000-007
WMB marking card; as card; not stretchable; plain; snap-on type

www.wago.com/793-501/000-007



Item no.: 793-501/000-012
WMB marking card; as card; not stretchable; plain; snap-on type

www.wago.com/793-501/000-012



Item no.: 793-501/000-017
WMB marking card; as card; not stretchable; plain; snap-on type

www.wago.com/793-501/000-017



Item no.: 793-501/000-023
WMB marking card; as card; not stretchable; plain; snap-on type

www.wago.com/793-501/000-023



Item no.: 793-501/000-024
WMB marking card; as card; not stretchable; plain; snap-on type

www.wago.com/793-501/000-024



Item no.: 793-5501
WMB marking card; as card; for terminal block width 5 - 17.5 mm; stretchable 5 - 5.2 mm; plain; snap-on type

www.wago.com/793-5501



Item no.: 793-5501/000-002
WMB marking card; as card; for terminal block width 5 - 17.5 mm; stretchable 5 - 5.2 mm; plain; snap-on type

www.wago.com/793-5501/000-002



Item no.: 793-5501/000-005
WMB marking card; as card; stretchable 5 - 5.2 mm; plain; snap-on type

www.wago.com/793-5501/000-005



Item no.: 793-5501/000-006
WMB marking card; as card; stretchable 5 - 5.2 mm; plain; snap-on type

www.wago.com/793-5501/000-006



Item no.: 793-5501/000-007
WMB marking card; as card; stretchable 5 - 5.2 mm; plain; snap-on type

www.wago.com/793-5501/000-007



Item no.: 793-5501/000-012
WMB marking card; as card; stretchable 5 - 5.2 mm; plain; snap-on type

www.wago.com/793-5501/000-012



Item no.: 793-5501/000-017
WMB marking card; as card; stretchable 5 - 5.2 mm; plain; snap-on type

www.wago.com/793-5501/000-017



Item no.: 793-5501/000-023
WMB marking card; as card; stretchable 5 - 5.2 mm; plain; snap-on type

















www.wago.com/793-5501/000-023





Item no.: 793-5501/000-024
WMB marking card; as card; stretchable 5 - 5.2 mm; plain; snap-on type







www.wago.com/793-5501/000-024

check









	Item no.: 2002-511 Modular TOPJOB®S connector; modular; for jumper contact slot; 1-pole	www.wago.com/2002-511
	Item no.: 2002-549 Spacer module; modular; e.g., for bridging commoned terminal blocks	www.wago.com/2002-549
	Item no.: 2002-552 TOPJOB®S connector strip; for jumper contact slot; 2-pole	www.wago.com/2002-552
	Item no.: 2002-553 TOPJOB®S connector strip; for jumper contact slot; 3-pole	www.wago.com/2002-553
	Item no.: 2002-554 TOPJOB®S connector strip; for jumper contact slot; 4-pole	www.wago.com/2002-554
	Item no.: 2002-555 TOPJOB®S connector strip; for jumper contact slot; 5-pole	www.wago.com/2002-555
	Item no.: 2002-556 TOPJOB®S connector strip; for jumper contact slot; 6-pole	www.wago.com/2002-556
	Item no.: 2002-557 TOPJOB®S connector strip; for jumper contact slot; 7-pole	www.wago.com/2002-557
	Item no.: 2002-558 TOPJOB®S connector strip; for jumper contact slot; 8-pole	www.wago.com/2002-558
	Item no.: 2002-559 TOPJOB®S connector strip; for jumper contact slot; 9-pole	www.wago.com/2002-559
	Item no.: 2002-560 TOPJOB®S connector strip; for jumper contact slot; 10-pole	www.wago.com/2002-560
	Item no.: 2002-611 TOPJOB®S L-type test plug module; modular; 1-pole	www.wago.com/2002-611
	Item no.: 2002-649 TOPJOB®S L-type spacer module; modular; e.g., for bridging commoned terminal blocks	www.wago.com/2002-649
	Item no.: 2009-174 Test plug adapter; for 4 mm Ø test plugs; for testing TOPJOB®S rail-mounted terminal blocks	www.wago.com/2009-174
	Item no.: 2009-182 Testing tap; for max. 2.5 mm ² ; tool-free connection for individual test wires 0.08 - 2.5 mm	www.wago.com/2009-182
	Item no.: 210-136 Test plug; 2 mm Ø; with 500 mm cable	www.wago.com/210-136

Carrier rail



	Item no.: 210-112 Steel carrier rail; 35 x 7.5 mm; 1 mm thick; 2 m long; slotted; according to EN 60715; "Hole width 25 mm	www.wago.com/210-112
	Item no.: 210-113 Steel carrier rail; 35 x 7.5 mm; 1 mm thick; 2 m long; unslotted; according to EN 60715	www.wago.com/210-113

	Item no.: 210-114 Steel carrier rail; 35 x 15 mm; 1.5 mm thick; 2 m long; unslotted; similar to EN 60715	www.wago.com/210-114
	Item no.: 210-115 Steel carrier rail; 35 x 7.5 mm; 1 mm thick; 2 m long; slotted; according to EN 60715; "Hole width 18 mm	www.wago.com/210-115
	Item no.: 210-118 Steel carrier rail; 35 x 15 mm; 2.3 mm thick; 2 m long; unslotted; according to EN 60715	www.wago.com/210-118
	Item no.: 210-196 Aluminum carrier rail; 35 x 8.2 mm; 1.6 mm thick; 2 m long; unslotted; similar to EN 60715	www.wago.com/210-196
	Item no.: 210-197 Steel carrier rail; 35 x 15 mm; 1.5 mm thick; 2 m long; slotted; similar to EN 60715	www.wago.com/210-197
	Item no.: 210-198 Copper carrier rail; 35 x 15 mm; 2.3 mm thick; 2 m long; unslotted; according to EN 60715	www.wago.com/210-198

ferrule

	Item no.: 216-241 Ferrule; Sleeve for 0.5 mm ² / AWG 22; insulated; electro-tin plated; electrolytic copper; gastight crimped; acc. to DIN 46228, Part 4/09.90	www.wago.com/216-241
	Item no.: 216-242 Ferrule; Sleeve for 0.75 mm ² / AWG 20; insulated; electro-tin plated; electrolytic copper; gastight crimped; acc. to DIN 46228, Part 4/09.90	www.wago.com/216-242
	Item no.: 216-243 Ferrule; Sleeve for 1 mm ² / AWG 18; insulated; electro-tin plated; electrolytic copper; gastight crimped; acc. to DIN 46228, Part 4/09.90	www.wago.com/216-243
	Item no.: 216-244 Ferrule; Sleeve for 1.5 mm ² / AWG 16; insulated; electro-tin plated; electrolytic copper; gastight crimped; acc. to DIN 46228, Part 4/09.90	www.wago.com/216-244
	Item no.: 216-246 Ferrule; Sleeve for 2.5 mm ² / AWG 14; insulated; electro-tin plated; electrolytic copper; gastight crimped; acc. to DIN 46228, Part 4/09.90	www.wago.com/216-246
	Item no.: 216-262 Ferrule; Sleeve for 0.75 mm ² / AWG 20; insulated; electro-tin plated; electrolytic copper; gastight crimped; acc. to DIN 46228, Part 4/09.90	www.wago.com/216-262
	Item no.: 216-263 Ferrule; Sleeve for 1 mm ² / AWG 18; insulated; electro-tin plated; electrolytic copper; gastight crimped; acc. to DIN 46228, Part 4/09.90	www.wago.com/216-263
	Item no.: 216-264 Ferrule; Sleeve for 1.5 mm ² / AWG 16; insulated; electro-tin plated; electrolytic copper; gastight crimped; acc. to DIN 46228, Part 4/09.90	www.wago.com/216-264
	Item no.: 216-266 Ferrule; Sleeve for 2.5 mm ² / AWG 14; insulated; electro-tin plated; electrolytic copper; gastight crimped; acc. to DIN 46228, Part 4/09.90	www.wago.com/216-266













tools

















	Item no.: 210-658 Operating tool with partially insulated shaft; Blade (3.5 x 0.5) mm; short; angled	www.wago.com/210-658
	Item no.: 210-720 Operating tool with partially insulated shaft; Type 2, blade (3.5 x 0.5) mm	www.wago.com/210-720

















End plate













	Item no.: 2002-1891 End and intermediate plate; 1 mm thick	www.wago.com/2002-1891
	Item no.: 2002-1892 End and intermediate plate; 1 mm thick	www.wago.com/2002-1892

Jumper

	Item no.: 2002-400 Adjacent jumper for continuous commoning; insulated; 2-way; Nominal current 25 A	www.wago.com/2002-400
	Item no.: 2002-402 Push-in type jumper bar; insulated; 2-way; Nominal current 25 A	www.wago.com/2002-402
	Item no.: 2002-402/000-005 Push-in type jumper bar; insulated; 2-way; Nominal current 25 A	www.wago.com/2002-402/000-005
	Item no.: 2002-402/000-006 Push-in type jumper bar; insulated; 2-way; Nominal current 25 A	www.wago.com/2002-402/000-006
	Item no.: 2002-403 Push-in type jumper bar; insulated; 3-way; Nominal current 25 A	www.wago.com/2002-403
	Item no.: 2002-403/000-005 Push-in type jumper bar; insulated; 3-way; Nominal current 25 A	www.wago.com/2002-403/000-005
	Item no.: 2002-403/000-006 Push-in type jumper bar; insulated; 3-way; Nominal current 25 A	www.wago.com/2002-403/000-006
	Item no.: 2002-404 Push-in type jumper bar; insulated; 4-way; Nominal current 25 A	www.wago.com/2002-404
	Item no.: 2002-404/000-005 Push-in type jumper bar; insulated; 4-way; Nominal current 25 A	www.wago.com/2002-404/000-005
	Item no.: 2002-404/000-006 Push-in type jumper bar; insulated; 4-way; Nominal current 25 A	www.wago.com/2002-404/000-006
	Item no.: 2002-405 Push-in type jumper bar; insulated; 5-way; Nominal current 25 A	www.wago.com/2002-405
	Item no.: 2002-405/000-005 Push-in type jumper bar; insulated; 5-way; Nominal current 25 A	www.wago.com/2002-405/000-005
	Item no.: 2002-405/000-006 Push-in type jumper bar; insulated; 5-way; Nominal current 25 A	www.wago.com/2002-405/000-006

	Item no.: 2002-405/011-000 Star point jumper; insulated; 3-way (1-3-5); IN = IN terminal block	www.wago.com/2002-405/011-000
	Item no.: 2002-406 Push-in type jumper bar; insulated; 6-way; Nominal current 25 A	www.wago.com/2002-406
	Item no.: 2002-406/000-005 Push-in type jumper bar; insulated; 6-way; Nominal current 25 A	www.wago.com/2002-406/000-005
	Item no.: 2002-406/000-006 Push-in type jumper bar; insulated; 6-way; Nominal current 25 A	www.wago.com/2002-406/000-006
	Item no.: 2002-406/020-000 Delta jumper; insulated; 1-2 3-4 5-6; IN = IN terminal block	www.wago.com/2002-406/020-000
	Item no.: 2002-407 Push-in type jumper bar; insulated; 7-way; Nominal current 25 A	www.wago.com/2002-407
	Item no.: 2002-407/000-005 Push-in type jumper bar; insulated; 7-way; Nominal current 25 A	www.wago.com/2002-407/000-005
	Item no.: 2002-407/000-006 Push-in type jumper bar; insulated; 7-way; Nominal current 25 A	www.wago.com/2002-407/000-006
	Item no.: 2002-408 Push-in type jumper bar; insulated; 8-way; Nominal current 25 A	www.wago.com/2002-408
	Item no.: 2002-408/000-005 Push-in type jumper bar; insulated; 8-way; Nominal current 25 A	www.wago.com/2002-408/000-005
	Item no.: 2002-408/000-006 Push-in type jumper bar; insulated; 8-way; Nominal current 25 A	www.wago.com/2002-408/000-006
	Item no.: 2002-409 Push-in type jumper bar; insulated; 9-way; Nominal current 25 A	www.wago.com/2002-409
	Item no.: 2002-409/000-005 Push-in type jumper bar; insulated; 9-way; Nominal current 25 A	www.wago.com/2002-409/000-005
	Item no.: 2002-409/000-006 Push-in type jumper bar; insulated; 9-way; Nominal current 25 A	www.wago.com/2002-409/000-006
	Item no.: 2002-410 Push-in type jumper bar; insulated; 10-way; Nominal current 25 A	www.wago.com/2002-410
	Item no.: 2002-410/000-005 Push-in type jumper bar; insulated; 10-way; Nominal current 25 A	www.wago.com/2002-410/000-005

	Item no.: 2002-410/000-006 Push-in type jumper bar; insulated; 10-way; Nominal current 25 A	www.wago.com/2002-410/000-006
	Item no.: 2002-423 Push-in type jumper bar; insulated; from 1 to 3; Nominal current 25 A	www.wago.com/2002-423
	Item no.: 2002-423/000-005 Adjacent jumper for continuous commoning; insulated; from 1 to 3; Nominal current 25 A	www.wago.com/2002-423/000-005
	Item no.: 2002-423/000-006 Adjacent jumper for continuous commoning; insulated; from 1 to 3; Nominal current 25 A	www.wago.com/2002-423/000-006
	Item no.: 2002-433 Push-in type jumper bar; insulated; from 1 to 3; Nominal current 25 A	www.wago.com/2002-433
	Item no.: 2002-434 Push-in type jumper bar; insulated; from 1 to 4; Nominal current 25 A	www.wago.com/2002-434
	Item no.: 2002-435 Push-in type jumper bar; insulated; from 1 to 5; Nominal current 25 A	www.wago.com/2002-435
	Item no.: 2002-436 Push-in type jumper bar; insulated; from 1 to 6; Nominal current 25 A	www.wago.com/2002-436
	Item no.: 2002-437 Push-in type jumper bar; insulated; from 1 to 7; Nominal current 25 A	www.wago.com/2002-437
	Item no.: 2002-438 Push-in type jumper bar; insulated; from 1 to 8; Nominal current 25 A	www.wago.com/2002-438
	Item no.: 2002-439 Push-in type jumper bar; insulated; from 1 to 9; Nominal current 25 A	www.wago.com/2002-439
	Item no.: 2002-440 Push-in type jumper bar; insulated; from 1 to 10; Nominal current 25 A	www.wago.com/2002-440
	Item no.: 2002-472 Staggered jumper; insulated; 2-way; Nominal current 25 A; suitable for 2002 and 2003 Series rail-mounted terminal blocks	www.wago.com/2002-472
	Item no.: 2002-473 Staggered jumper; insulated; 3-way; Nominal current 25 A; suitable for 2002 and 2003 Series rail-mounted terminal blocks	www.wago.com/2002-473
	Item no.: 2002-473/011-000 Ready-made staggered jumper; insulated; 2-way (1-3); Nominal current 25 A; with contact lugs broken off at the factory and circuit marking	www.wago.com/2002-473/011-000
	Item no.: 2002-474 Staggered jumper; insulated; 4-way; Nominal current 25 A; suitable for 2002 and 2003 Series rail-mounted terminal blocks	www.wago.com/2002-474
	Item no.: 2002-475 Staggered jumper; insulated; 5-way; Nominal current 25 A; suitable for 2002 and 2003 Series rail-mounted terminal blocks	www.wago.com/2002-475
	Item no.: 2002-475/011-000 Ready-made staggered jumper; insulated; 3-way (1-3-5); Nominal current 25 A; with contact lugs broken off at the factory and circuit marking	www.wago.com/2002-475/011-000

	Item no.: 2002-476 Staggered jumper; insulated; 6-way; Nominal current 25 A; suitable for 2002 and 2003 Series rail-mounted terminal blocks	www.wago.com/2002-476
	Item no.: 2002-477 Staggered jumper; insulated; 7-way; Nominal current 25 A; suitable for 2002 and 2003 Series rail-mounted terminal blocks	www.wago.com/2002-477
	Item no.: 2002-477/011-000 Ready-made staggered jumper; insulated; 1-3-5-7; Nominal current 25 A; with contact lugs broken off at the factory and circuit marking	www.wago.com/2002-477/011-000
	Item no.: 2002-478 Staggered jumper; insulated; 8-way; Nominal current 25 A; suitable for 2002 and 2003 Series rail-mounted terminal blocks	www.wago.com/2002-478
	Item no.: 2002-479 Staggered jumper; insulated; 9-way; Nominal current 25 A; suitable for 2002 and 2003 Series rail-mounted terminal blocks	www.wago.com/2002-479
	Item no.: 2002-479/011-000 Ready-made staggered jumper; insulated; 1-3-5-7-9; Nominal current 25 A; with contact lugs broken off at the factory and circuit marking	www.wago.com/2002-479/011-000
	Item no.: 2002-480 Staggered jumper; insulated; 10-way; Nominal current 25 A; suitable for 2002 and 2003 Series rail-mounted terminal blocks	www.wago.com/2002-480
	Item no.: 2002-481 Staggered jumper; insulated; 11-way; Nominal current 25 A; suitable for 2002 and 2003 Series rail-mounted terminal blocks	www.wago.com/2002-481
	Item no.: 2002-481/011-000 Ready-made staggered jumper; insulated; 1-3-5-7-9-11; Nominal current 25 A; with contact lugs broken off at the factory and circuit marking	www.wago.com/2002-481/011-000
	Item no.: 2002-482 Staggered jumper; insulated; 12-way; Nominal current 25 A; suitable for 2002 and 2003 Series rail-mounted terminal blocks	www.wago.com/2002-482
	Item no.: 2009-412 Push-in type wire jumper; insulated; wire length 60 mm; Conductor cross section 1.5 mm ² ; suitable for 2001, 2002, 2003 and 2022 Series rail-mounted terminal blocks	www.wago.com/2009-412
	Item no.: 2009-414 Push-in type wire jumper; insulated; wire length 110 mm; Conductor cross section 1.5 mm ² ; suitable for 2001, 2002, 2003 and 2022 Series rail-mounted terminal blocks	www.wago.com/2009-414
	Item no.: 2009-416 Push-in type wire jumper; insulated; wire length 250 mm; Conductor cross section 1.5 mm ² ; suitable for 2001, 2002, 2003 and 2022 Series rail-mounted terminal blocks	www.wago.com/2009-416
	Item no.: 210-103 Wire commoning chain; insulated; 50 connections	www.wago.com/210-103
	Item no.: 210-123 Wire commoning chain; insulated; 50 connections	www.wago.com/210-123

Protective Warning Marker

	Item no.: 2002-115 Protective warning marker; with high-voltage symbol, black; for 5 terminal blocks	www.wago.com/2002-115
--	--	--

Insulation stop



Item no.: 2002-171
Insulation stop; 0.25 - 0.5 mm²; 5 pieces/strip

www.wago.com/2002-171



Item no.: 2002-172
Insulation stop; 0.75 - 1 mm²; 5 pieces/strip

www.wago.com/2002-172

General accessories



Item no.: 2002-121
Adaptor

www.wago.com/2002-121

Downloads

Documentation

Bid Text

2002-1872/401-000	Aug 13, 2018	DOCX 15.7 kB	Download
-------------------	--------------	-----------------	----------

smartDATA

CAD data

3D Download 2002-1872/401-000	URL	Download
-------------------------------	-----	----------

Subject to changes.