

Data sheet | Item number: 2004-1205

2-conductor through terminal block; 4 mm²; suitable for Ex e II applications;
side and center marking; for DIN-rail 35 x 15 and 35 x 7.5; Push-in CAGE
CLAMP®

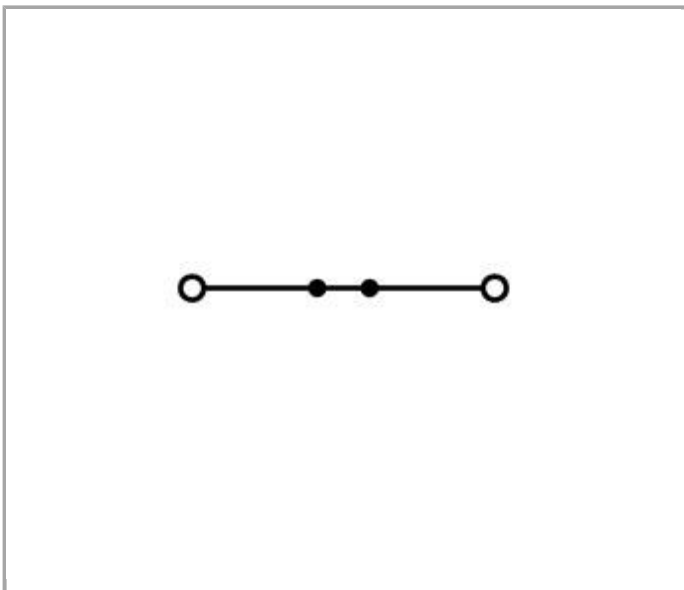

www.wago.com/2004-1205

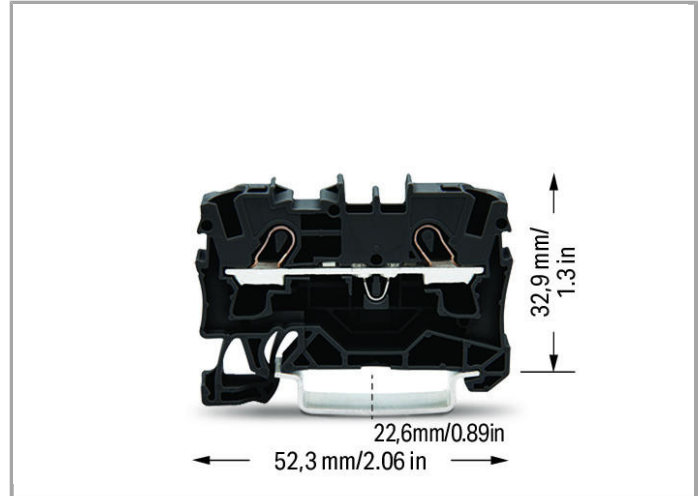

Data

Electrical data

Rated voltage EN (Ex e II)	550 V
Rated current (Ex e II)	30 A



Ratings per IEC/EN 60664-1

Rated voltage (III / 3)	800 V
Rated impulse voltage (III / 3)	8 kV
Rated current	32 A
Rated current (2)	41 A
Legend (ratings)	(III / 3) \triangleq Overvoltage category III / Pollution degree 3

Approvals per UL 1059

Rated voltage UL (Use Group B)	600 V
Rated current UL (Use Group B)	30 A
Rated voltage UL (Use Group C)	600 V
Rated current UL (Use Group C)	30 A

Approvals per CSA

Rated voltage CSA (Use Group B)	600 V
Rated current CSA (Use Group B)	30 A
Rated voltage CSA (Use Group C)	600 V
Rated current CSA (Use Group C)	30 A

Connection data

Connection technology	Push-in CAGE CLAMP [®]
Actuation type	Push-in Operating tool
Connectable conductor materials	Copper
Nominal cross section	4 mm ²
Solid conductor	0.5 ... 6 mm ² / 20 ... 10 AWG
Solid conductor, push-in termination	1.5 ... 6 mm ² / 14 ... 10 AWG
Fine-stranded conductor	0.5 ... 6 mm ² / 20 ... 10 AWG
Fine-stranded conductor with ferrule, push-in termination, from	1.5 mm ² / 18 AWG
Strip length	11 ... 13 mm / 0.43 ... 0.51 Inch
Total number of connection points	2
Total number of potentials	1
Number of levels	1
Type of wiring	Front-entry wiring

Geometrical Data

Width	6.2 mm / 0.244 inch
Height from upper-edge of DIN-35 rail	32.9 mm / 1.295 inch
Depth	52.3 mm / 2.059 inch

Mechanical data

Design	horizontal
Type of mounting	DIN-35 rail
Marking level	Center/side marking

Material Data



Color	black
Insulating material	Polyamide 66 (PA 66)
Fire load	0.114 MJ
Weight	6.325 g

Commercial data



Country of origin	DE
GTIN	4045454537449
Customs Tariff No.	85369010000
Product Group	22 (TOPJOB S)

Approvals / Certificates



Ex-Approvals

Logo	Approval	Certificate name
	AEx Underwriters Laboratories Inc.	E185892
	ATEX Physikalisch Technische Bundesanstalt (PTB)	PTB 05 ATEX 1095 U (II 2 G/D Ex eII bzw. I M2 Ex eI)

Country specific Approvals

Logo	Approval	Certificate name
	CCA DEKRA Certification B.V.	2160584.10
	CCA DEKRA Certification B.V.	NTR NL-7088
	CSA DEKRA Certification B.V.	1645435

Ship Approvals







Logo	Approval	Certificate name
	ABS American Bureau of Shipping	14-HG1293677-PDA
	BV Bureau Veritas S.A.	38586/A0 BV
	LR Lloyds Register	91/20112 (E9)

















UL-Approvals

Logo	Approval	Certificate name
	UL UL International Germany GmbH	E45172

Compatible products

Marking accessories

	Item no.: 2009-110 Marking strips; on reel; not stretchable; plain; snap-on type	www.wago.com/2009-110
	Item no.: 2009-115 WMB-Inline; for smartPRINTER; on reel; stretchable 5 - 5.2 mm; plain; snap-on type	www.wago.com/2009-115
	Item no.: 2009-115/000-002 WMB-Inline; for smartPRINTER; on reel; stretchable 5 - 5.2 mm; plain; snap-on type	www.wago.com/2009-115/000-002
	Item no.: 2009-115/000-006 WMB-Inline; for smartPRINTER; on reel; stretchable 5 - 5.2 mm; plain; snap-on type	www.wago.com/2009-115/000-006
	Item no.: 2009-115/000-007 WMB-Inline; for smartPRINTER; on reel; stretchable 5 - 5.2 mm; plain; snap-on type	www.wago.com/2009-115/000-007
	Item no.: 2009-115/000-012 WMB-Inline; for smartPRINTER; on reel; stretchable 5 - 5.2 mm; plain; snap-on type	www.wago.com/2009-115/000-012
	Item no.: 2009-115/000-017 WMB-Inline; for smartPRINTER; on reel; stretchable 5 - 5.2 mm; plain; snap-on type	www.wago.com/2009-115/000-017

	<p>Item no.: 2009-115/000-023 WMB-Inline; for smartPRINTER; on reel; stretchable 5 - 5.2 mm; plain; snap-on type</p>	www.wago.com/2009-115/000-023
	<p>Item no.: 2009-115/000-024 WMB-Inline; for smartPRINTER; on reel; stretchable 5 - 5.2 mm; plain; snap-on type</p>	www.wago.com/2009-115/000-024
	<p>Item no.: 2009-135 WMB-Inline; for smartPRINTER; on reel; stretchable 5 - 5.2 mm; plain; snap-on type</p>	www.wago.com/2009-135
	<p>Item no.: 2009-145 Mini-WSB Inline; for smartPRINTER; on reel; stretchable 5 - 5.2 mm; plain; snap-on type</p>	www.wago.com/2009-145
	<p>Item no.: 2009-145/000-002 Mini-WSB Inline; for smartPRINTER; on reel; stretchable 5 - 5.2 mm; plain; snap-on type</p>	www.wago.com/2009-145/000-002
	<p>Item no.: 2009-145/000-005 Mini-WSB Inline; for smartPRINTER; on reel; stretchable 5 - 5.2 mm; plain; snap-on type</p>	www.wago.com/2009-145/000-005
	<p>Item no.: 2009-145/000-006 Mini-WSB Inline; for smartPRINTER; on reel; stretchable 5 - 5.2 mm; plain; snap-on type</p>	www.wago.com/2009-145/000-006
	<p>Item no.: 2009-145/000-007 Mini-WSB Inline; for smartPRINTER; on reel; stretchable 5 - 5.2 mm; plain; snap-on type</p>	www.wago.com/2009-145/000-007
	<p>Item no.: 2009-145/000-012 Mini-WSB Inline; for smartPRINTER; on reel; stretchable 5 - 5.2 mm; plain; snap-on type</p>	www.wago.com/2009-145/000-012
	<p>Item no.: 2009-145/000-023 Mini-WSB Inline; for smartPRINTER; on reel; stretchable 5 - 5.2 mm; plain; snap-on type</p>	www.wago.com/2009-145/000-023
	<p>Item no.: 2009-145/000-024 Mini-WSB Inline; on reel; stretchable 5 - 5.2 mm; plain; snap-on type</p>	www.wago.com/2009-145/000-024
	<p>Item no.: 2009-191 Group marker carrier</p>	www.wago.com/2009-191
	<p>Item no.: 2009-192 Group marker carrier</p>	www.wago.com/2009-192
	<p>Item no.: 2009-193 Group marker carrier</p>	www.wago.com/2009-193
	<p>Item no.: 2009-198 Adaptor</p>	www.wago.com/2009-198
	<p>Item no.: 248-501 Miniature WSB Quick marking system; plain; Marker width 5 mm; 10 strips with 10 markers per card</p>	www.wago.com/248-501
	<p>Item no.: 248-501/000-002 Mini-WSB marking card; as card; not stretchable; plain; snap-on type</p>	www.wago.com/248-501/000-002



Item no.: 248-501/000-005
Mini-WSB marking card; as card; plain; snap-on type

www.wago.com/248-501/000-005



Item no.: 248-501/000-006
Mini-WSB marking card; as card; not stretchable; plain; snap-on type

www.wago.com/248-501/000-006



Item no.: 248-501/000-007
Mini-WSB marking card; as card; not stretchable; plain; snap-on type

www.wago.com/248-501/000-007



Item no.: 248-501/000-012
Mini-WSB marking card; as card; not stretchable; plain; snap-on type

www.wago.com/248-501/000-012



Item no.: 248-501/000-017
Mini-WSB marking card; as card; not stretchable; plain; snap-on type

www.wago.com/248-501/000-017



Item no.: 248-501/000-023
Mini-WSB marking card; as card; not stretchable; plain; snap-on type

www.wago.com/248-501/000-023



Item no.: 248-501/000-024
Mini-WSB marking card; as card; not stretchable; plain; snap-on type

www.wago.com/248-501/000-024



Item no.: 793-501
WMB marking card; as card; not stretchable; plain; snap-on type

www.wago.com/793-501



Item no.: 793-501/000-002
WMB marking card; as card; not stretchable; plain; snap-on type

www.wago.com/793-501/000-002



Item no.: 793-501/000-005
WMB marking card; as card; not stretchable; plain; snap-on type

www.wago.com/793-501/000-005



Item no.: 793-501/000-006
WMB marking card; as card; not stretchable; plain; snap-on type

www.wago.com/793-501/000-006



Item no.: 793-501/000-007
WMB marking card; as card; not stretchable; plain; snap-on type

www.wago.com/793-501/000-007



Item no.: 793-501/000-012
WMB marking card; as card; not stretchable; plain; snap-on type

www.wago.com/793-501/000-012



Item no.: 793-501/000-017
WMB marking card; as card; not stretchable; plain; snap-on type

www.wago.com/793-501/000-017



Item no.: 793-501/000-023
WMB marking card; as card; not stretchable; plain; snap-on type

www.wago.com/793-501/000-023



Item no.: 793-501/000-024
WMB marking card; as card; not stretchable; plain; snap-on type

www.wago.com/793-501/000-024



Item no.: 793-5501
WMB marking card; as card; for terminal block width 5 - 17.5 mm; stretchable 5 - 5.2 mm; plain; snap-on type

www.wago.com/793-5501



Item no.: 793-5501/000-002
WMB marking card; as card; for terminal block width 5 - 17.5 mm; stretchable 5 - 5.2 mm; plain; snap-on type

www.wago.com/793-5501/000-002



Item no.: 793-5501/000-005
WMB marking card; as card; stretchable 5 - 5.2 mm; plain; snap-on type

www.wago.com/793-5501/000-005



Item no.: 793-5501/000-006
WMB marking card; as card; stretchable 5 - 5.2 mm; plain; snap-on type

www.wago.com/793-5501/000-006



Item no.: 793-5501/000-007
WMB marking card; as card; stretchable 5 - 5.2 mm; plain; snap-on type

www.wago.com/793-5501/000-007



Item no.: 793-5501/000-012
WMB marking card; as card; stretchable 5 - 5.2 mm; plain; snap-on type

www.wago.com/793-5501/000-012



Item no.: 793-5501/000-017
WMB marking card; as card; stretchable 5 - 5.2 mm; plain; snap-on type

www.wago.com/793-5501/000-017



Item no.: 793-5501/000-023
WMB marking card; as card; stretchable 5 - 5.2 mm; plain; snap-on type

www.wago.com/793-5501/000-023



Item no.: 793-5501/000-024
WMB marking card; as card; stretchable 5 - 5.2 mm; plain; snap-on type

www.wago.com/793-5501/000-024

Insulation stop



Item no.: 2004-171
Insulation stop; 0.25 - 0.5 mm²; 5 pieces/strip

www.wago.com/2004-171



Item no.: 2004-172
Insulation stop; 0.75 - 1 mm²; 5 pieces/strip

www.wago.com/2004-172





Protective Warning Marker











Item no.: 2004-115
Protective warning marker; with high-voltage symbol, black; for 5 terminal blocks

www.wago.com/2004-115





ferrule



















	Item no.: 216-262 Ferrule; Sleeve for 0.75 mm ² / AWG 20; insulated; electro-tin plated; electrolytic copper; gastight crimped; acc. to DIN 46228, Part 4/09.90	www.wago.com/216-262
	Item no.: 216-263 Ferrule; Sleeve for 1 mm ² / AWG 18; insulated; electro-tin plated; electrolytic copper; gastight crimped; acc. to DIN 46228, Part 4/09.90	www.wago.com/216-263
	Item no.: 216-264 Ferrule; Sleeve for 1.5 mm ² / AWG 16; insulated; electro-tin plated; electrolytic copper; gastight crimped; acc. to DIN 46228, Part 4/09.90	www.wago.com/216-264
	Item no.: 216-266 Ferrule; Sleeve for 2.5 mm ² / AWG 14; insulated; electro-tin plated; electrolytic copper; gastight crimped; acc. to DIN 46228, Part 4/09.90	www.wago.com/216-266
	Item no.: 216-267 Ferrule; Sleeve for 4 mm ² / AWG 12; insulated; electro-tin plated; electrolytic copper; gastight crimped; acc. to DIN 46228, Part 4/09.90	www.wago.com/216-267

Carrier rail



	Item no.: 210-112 Steel carrier rail; 35 x 7.5 mm; 1 mm thick; 2 m long; slotted; according to EN 60715; "Hole width 25 mm	www.wago.com/210-112
	Item no.: 210-113 Steel carrier rail; 35 x 7.5 mm; 1 mm thick; 2 m long; unslotted; according to EN 60715	www.wago.com/210-113
	Item no.: 210-114 Steel carrier rail; 35 x 15 mm; 1.5 mm thick; 2 m long; unslotted; similar to EN 60715	www.wago.com/210-114
	Item no.: 210-115 Steel carrier rail; 35 x 7.5 mm; 1 mm thick; 2 m long; slotted; according to EN 60715; "Hole width 18 mm	www.wago.com/210-115
	Item no.: 210-118 Steel carrier rail; 35 x 15 mm; 2.3 mm thick; 2 m long; unslotted; according to EN 60715	www.wago.com/210-118
	Item no.: 210-196 Aluminum carrier rail; 35 x 8.2 mm; 1.6 mm thick; 2 m long; unslotted; similar to EN 60715	www.wago.com/210-196
	Item no.: 210-197 Steel carrier rail; 35 x 15 mm; 1.5 mm thick; 2 m long; slotted; similar to EN 60715	www.wago.com/210-197
	Item no.: 210-198 Copper carrier rail; 35 x 15 mm; 2.3 mm thick; 2 m long; unslotted; according to EN 60715	www.wago.com/210-198

Jumper









	Item no.: 2004-402 Push-in type jumper bar; insulated; 2-way; Nominal current 32 A	www.wago.com/2004-402
	Item no.: 2004-403 Push-in type jumper bar; insulated; 3-way; Nominal current 32 A	www.wago.com/2004-403
	Item no.: 2004-404 Push-in type jumper bar; insulated; 4-way; Nominal current 32 A	www.wago.com/2004-404
	Item no.: 2004-405 Push-in type jumper bar; insulated; 5-way; Nominal current 32 A	www.wago.com/2004-405

	Item no.: 2004-405/011-000 Star point jumper; insulated; 3-way (1-3-5); IN = IN terminal block	www.wago.com/2004-405/011-000
	Item no.: 2004-406 Push-in type jumper bar; insulated; 6-way; Nominal current 32 A	www.wago.com/2004-406
	Item no.: 2004-406/020-000 Delta jumper; insulated; 1-2 3-4 5-6; IN = IN terminal block	www.wago.com/2004-406/020-000
	Item no.: 2004-407 Push-in type jumper bar; insulated; 7-way; Nominal current 32 A	www.wago.com/2004-407
	Item no.: 2004-408 Push-in type jumper bar; insulated; 8-way; Nominal current 32 A	www.wago.com/2004-408
	Item no.: 2004-409 Push-in type jumper bar; insulated; 9-way; Nominal current 32 A	www.wago.com/2004-409
	Item no.: 2004-410 Push-in type jumper bar; insulated; 10-way; Nominal current 32 A	www.wago.com/2004-410
	Item no.: 2004-433 Push-in type jumper bar; insulated; from 1 to 3; Nominal current 32 A	www.wago.com/2004-433
	Item no.: 2004-434 Push-in type jumper bar; insulated; from 1 to 4; Nominal current 32 A	www.wago.com/2004-434
	Item no.: 2004-435 Push-in type jumper bar; insulated; from 1 to 5; Nominal current 32 A	www.wago.com/2004-435
	Item no.: 2004-436 Push-in type jumper bar; insulated; from 1 to 6; Nominal current 32 A	www.wago.com/2004-436
	Item no.: 2004-437 Push-in type jumper bar; insulated; from 1 to 7; Nominal current 32 A	www.wago.com/2004-437
	Item no.: 2004-438 Push-in type jumper bar; insulated; from 1 to 8; Nominal current 32 A	www.wago.com/2004-438
	Item no.: 2004-439 Push-in type jumper bar; insulated; from 1 to 9; Nominal current 32 A	www.wago.com/2004-439
	Item no.: 2004-440 Push-in type jumper bar; insulated; from 1 to 10; Nominal current 32 A	www.wago.com/2004-440
	Item no.: 2006-499 Step-down jumper; insulated; from 6/4 mm ² to 4/2.5/1.5 mm ² ; Nominal current 32 A	www.wago.com/2006-499
	Item no.: 2016-499 Step-down jumper; insulated; from 16/10 mm ² to 10/6/4/2.5 mm ² ; Nominal current 57 A	www.wago.com/2016-499
	Item no.: 210-103 Wire commoning chain; insulated; 50 connections	www.wago.com/210-103
	Item no.: 210-123 Wire commoning chain; insulated; 50 connections	www.wago.com/210-123



tools

	Item no.: 210-658 Operating tool with partially insulated shaft; Blade (3.5 x 0.5) mm; short; angled	www.wago.com/210-658
	Item no.: 210-720 Operating tool with partially insulated shaft; Type 2, blade (3.5 x 0.5) mm	www.wago.com/210-720

check

	Item no.: 2004-511 Modular TOPJOB®S connector; modular; for jumper contact slot; 1-pole	www.wago.com/2004-511
	Item no.: 2004-549 Spacer module; modular; e.g., for bridging commoned terminal blocks	www.wago.com/2004-549
	Item no.: 2004-552 TOPJOB®S connector strip; for jumper contact slot; 2-pole	www.wago.com/2004-552
	Item no.: 2004-553 TOPJOB®S connector strip; for jumper contact slot; 3-pole	www.wago.com/2004-553
	Item no.: 2004-554 TOPJOB®S connector strip; for jumper contact slot; 4-pole	www.wago.com/2004-554
	Item no.: 2004-555 TOPJOB®S connector strip; for jumper contact slot; 5-pole	www.wago.com/2004-555
	Item no.: 2009-174 Test plug adapter; for 4 mm Ø test plugs; for testing TOPJOB®S rail-mounted terminal blocks	www.wago.com/2009-174
	Item no.: 2009-182 Testing tap; for max. 2.5 mm ² ; tool-free connection for individual test wires 0.08 - 2.5 mm	www.wago.com/2009-182

End plate

	Item no.: 2004-1291 End and intermediate plate; 1 mm thick	www.wago.com/2004-1291
	Item no.: 2004-1292 End and intermediate plate; 1 mm thick	www.wago.com/2004-1292
	Item no.: 2004-1293 Separator plate; 2 mm thick; oversized	www.wago.com/2004-1293
	Item no.: 2004-1294 Separator plate; 2 mm thick; oversized	www.wago.com/2004-1294
	Item no.: 209-190 Separator for Ex e/Ex i applications; 3 mm thick; 90 mm wide	www.wago.com/209-190
	Item no.: 209-191 Separator for Ex e/Ex i applications; 3 mm thick; 120 mm wide	www.wago.com/209-191



Downloads

Documentation

Bid Text

2004-1205	Aug 13, 2018	DOCX	Download
Reihenklennen, TOPJOB S		15.0 kB	

smartDATA

CAD data

3D Download 2004-1205		URL	Download
-----------------------	--	-----	----------

Subject to changes.