

Data sheet | Item number: 862-1662/999-950

4-conductor Ex e II chassis-mount terminal strip; for self-tapping screw 2.9 mm Ø from bellow; L1-N; with 2x pin; suitable for Ex e II applications; 2-pole

[www.wago.com/862-1662/999-950](http://www.wago.com/862-1662/999-950)

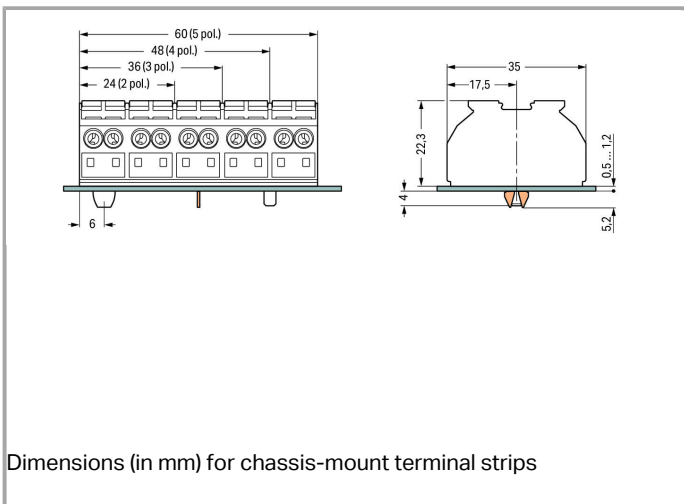

Data

Electrical data

Rated voltage EN (Ex e II)	440 V
----------------------------	-------

### Ratings per IEC/EN 60664-1

Rated current	28 A
---------------	------

### Connection data

Connection technology	Push-in CAGE CLAMP®
Actuation type	Operating tool
Connectable conductor materials	Copper Aluminum
Solid conductor	0.5 ... 4 mm <sup>2</sup> / 20 ... 12 AWG
Solid conductor, push-in termination	0.75 ... 4 mm <sup>2</sup> / 18 ... 12 AWG
Stranded conductor	0.5 ... 4 mm <sup>2</sup> / 20 ... 12 AWG
Fine-stranded conductor	0.5 ... 4 mm <sup>2</sup> / 20 ... 12 AWG
Fine-stranded conductor with ferrule with plastic collar	0.5 ... 2.5 mm <sup>2</sup> / 20 ... 12 AWG
Fine-stranded conductor with ferrule, push-in termination, from	0.75 mm <sup>2</sup> / 18 AWG
Strip length	10 ... 11 mm / 0.39 ... 0.43 Inch
No. of poles	2
Total number of connection points	8
Total number of potentials	2
Type of wiring	Side-entry wiring

### Geometrical Data

Pin spacing	12 mm / 0.472 inch
Width	24 mm / 0.945 inch
Height from the surface	22.3 mm / 0.878 inch
Depth	35 mm / 1.378 inch

### Mechanical data

Mounting type	Screw mounting
Marking	L1-N

### Material Data

Color	white
Fire load	0.267 MJ
Weight	14.118 g



### Commercial data

Packaging type	bag
----------------	-----

Country of origin	DE
GTIN	4045454803520
Customs Tariff No.	85369010000

## Approvals / Certificates

### Ex-Approvals

Logo	Approval	Certificate name
	ATEX Physikalisch Technische Bundesanstalt (PTB)	PTB 03 ATEX 1189 U (II 2 G Ex e II)
	IECEX Physikalisch Technische Bundesanstalt	IECEX PTB 05.0003 U

### Country specific Approvals

Logo	Approval	Certificate name
	CSA DEKRA Certification B.V.	1505030

### Ship Approvals



Logo	Approval	Certificate name
	LR Lloyds Register	91/20112 (E9)





## Compatible products

### tools



	<b>Item no.: 210-720</b> Operating tool with partially insulated shaft; Type 2, blade (3.5 x 0.5) mm	<a href="http://www.wago.com/210-720">www.wago.com/210-720</a>
------------------------------------------------------------------------------------	---------------------------------------------------------------------------------------------------------	----------------------------------------------------------------

### ferrule

	<b>Item no.: 216-141</b> Ferrule; Sleeve for 0.5 mm <sup>2</sup> / AWG 22; uninsulated; electro-tin plated; electrolytic copper; gastight crimped; acc. to DIN 46228, Part 1/08.92	<a href="http://www.wago.com/216-141">www.wago.com/216-141</a>
	<b>Item no.: 216-142</b> Ferrule; Sleeve for 0.75 mm <sup>2</sup> / AWG 20; uninsulated; electro-tin plated; electrolytic copper; gastight crimped; acc. to DIN 46228, Part 1/08.92	<a href="http://www.wago.com/216-142">www.wago.com/216-142</a>
	<b>Item no.: 216-143</b> Ferrule; Sleeve for 1 mm <sup>2</sup> / AWG 18; uninsulated; electro-tin plated; electrolytic copper; gastight crimped; acc. to DIN 46228, Part 1/08.92	<a href="http://www.wago.com/216-143">www.wago.com/216-143</a>
	<b>Item no.: 216-144</b>	

	Ferrule; Sleeve for 1.5 mm <sup>2</sup> / AWG 16; uninsulated; electro-tin plated; electrolytic copper; gastight crimped; acc. to DIN 46228, Part 1/08.92	<a href="http://www.wago.com/216-144">www.wago.com/216-144</a>
	<b>Item no.: 216-241</b> Ferrule; Sleeve for 0.5 mm <sup>2</sup> / AWG 22; insulated; electro-tin plated; electrolytic copper; gastight crimped; acc. to DIN 46228, Part 4/09.90	<a href="http://www.wago.com/216-241">www.wago.com/216-241</a>
	<b>Item no.: 216-242</b> Ferrule; Sleeve for 0.75 mm <sup>2</sup> / AWG 20; insulated; electro-tin plated; electrolytic copper; gastight crimped; acc. to DIN 46228, Part 4/09.90	<a href="http://www.wago.com/216-242">www.wago.com/216-242</a>
	<b>Item no.: 216-243</b> Ferrule; Sleeve for 1 mm <sup>2</sup> / AWG 18; insulated; electro-tin plated; electrolytic copper; gastight crimped; acc. to DIN 46228, Part 4/09.90	<a href="http://www.wago.com/216-243">www.wago.com/216-243</a>
	<b>Item no.: 216-244</b> Ferrule; Sleeve for 1.5 mm <sup>2</sup> / AWG 16; insulated; electro-tin plated; electrolytic copper; gastight crimped; acc. to DIN 46228, Part 4/09.90	<a href="http://www.wago.com/216-244">www.wago.com/216-244</a>

**Marking accessories**

	<b>Item no.: 709-177</b> Marking strips; on reel; 7.5 mm wide; not stretchable; plain; snap-on type	<a href="http://www.wago.com/709-177">www.wago.com/709-177</a>
	<b>Item no.: 709-178</b> Marking strips; on reel; 7.5 mm wide; not stretchable; plain; snap-on type	<a href="http://www.wago.com/709-178">www.wago.com/709-178</a>

**Jumper**

	<b>Item no.: 862-482</b> Comb-style jumper bar; for conductor entry; insulated; terminated conductor entry	<a href="http://www.wago.com/862-482">www.wago.com/862-482</a>
------------------------------------------------------------------------------------	---------------------------------------------------------------------------------------------------------------	----------------------------------------------------------------

**check**

	<b>Item no.: 210-136</b> Test plug; 2 mm Ø; with 500 mm cable	<a href="http://www.wago.com/210-136">www.wago.com/210-136</a>
	<b>Item no.: 210-137</b> Test plug; 2.3 mm Ø; with 500 mm cable	<a href="http://www.wago.com/210-137">www.wago.com/210-137</a>

**Downloads**

**Documentation**

**Bid Text**

862-1662/999-950	Oct 19, 2017	DOC 25.1 kB	Download
------------------	--------------	----------------	----------

**smartDATA**

**CAD data**

3D Download 862-1662/999-950	URL	Download
------------------------------	-----	----------



Subject to changes.

---

WAGO Kontakttechnik GmbH & Co. KG

Hansastr. 27

32423 Minden

Phone: +49571 887-0 | Fax: +49571 887-169

Email: [info.de@wago.com](mailto:info.de@wago.com) | Web: [www.wago.com](http://www.wago.com)

Do you have any questions about our products?

We are always happy to take your call at +49 (571) 887-44222.