

## D-SUB cable - VS-15-DSUB-20-LI-5,0 - 1656288

Please be informed that the data shown in this PDF Document is generated from our Online Catalog. Please find the complete data in the user's documentation. Our General Terms of Use for Downloads are valid (<http://download.phoenixcontact.com>)



Assembled D-SUB cable shielded, 15-pos., stranded (7-wire), cable color RAL 7000 (gray), IP20 degree of protection, head 1 with socket shell 2 and straight cable outlet, head 2 with pin shell 2 and straight cable outlet, length: 5 m

### Key commercial data

<b>package_quantity</b>	1
<b>GTIN</b>	4046356029766

### Technical data

#### Mechanical characteristics

<b>Number of positions</b>	15
<b>Insertion/withdrawal cycles</b>	≥ 50
<b>Cable exit</b>	Straight
<b>Length of cable</b>	5 m

#### Ambient conditions

<b>Ambient temperature (operation)</b>	0 °C ... 70 °C
<b>Degree of protection</b>	IP20

#### Material data

<b>Housing material</b>	PVC
<b>Contact material</b>	Copper alloy
<b>Contact surface material</b>	Gold-plated
<b>Outer sheath, material</b>	PVC

#### Electrical characteristics

<b>Rated voltage (III/3)</b>	125 V
<b>Rated current</b>	1 A

### classifications

#### eCl@ss

<b>eCl@ss 4.0</b>	27060306
<b>eCl@ss 4.1</b>	27060306
<b>eCl@ss 5.0</b>	27061801
<b>eCl@ss 5.1</b>	27061801
<b>eCl@ss 6.0</b>	27061801

# D-SUB cable - VS-15-DSUB-20-LI-5,0 - 1656288

## classifications

### eCl@ss

eCl@ss 7.0	27061801
eCl@ss 8.0	27061801

### ETIM

ETIM 2.0	EC000830
ETIM 3.0	EC001855
ETIM 4.0	EC001855
ETIM 5.0	EC001855

### UNSPSC

UNSPSC 6.01	31261501
UNSPSC 7.0901	31261501
UNSPSC 11	31261501
UNSPSC 12.01	31261501
UNSPSC 13.2	31261501

## Drawings

### Dimensioned drawing

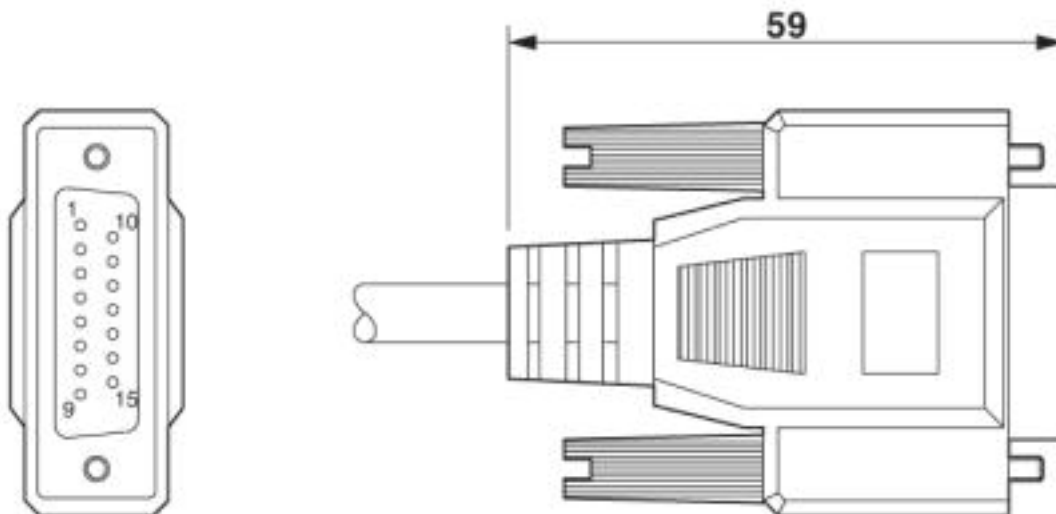

# D-SUB cable - VS-15-DSUB-20-LI-5,0 - 1656288

Dimensioned drawing

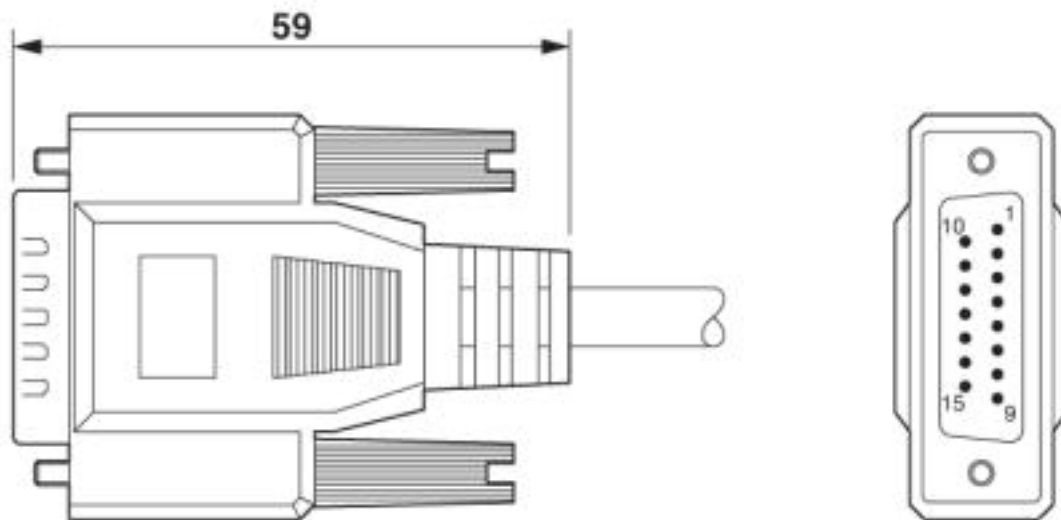

Circuit diagram

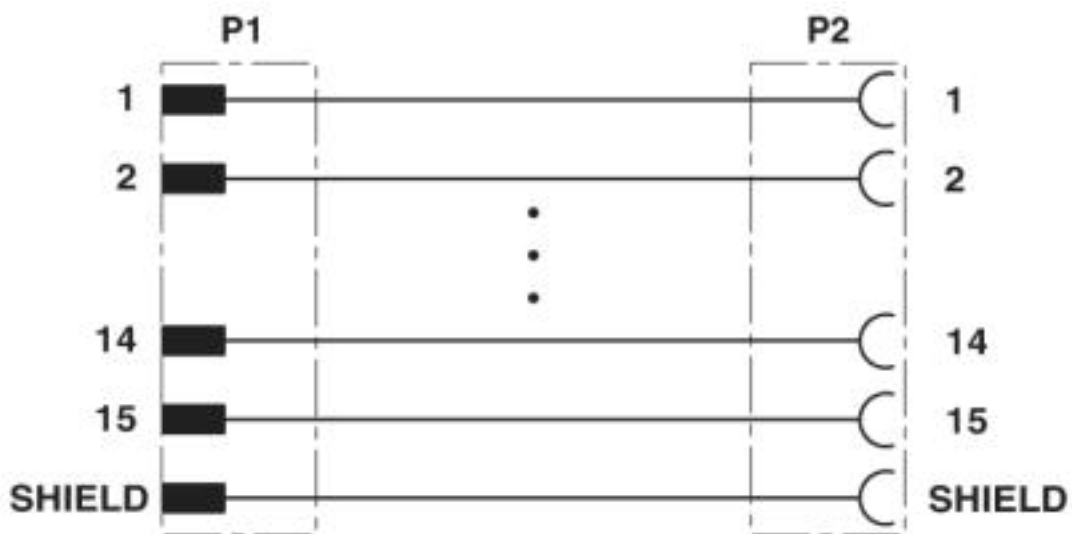

# D-SUB cable - VS-15-DSUB-20-LI-5,0 - 1656288

Schematic diagram

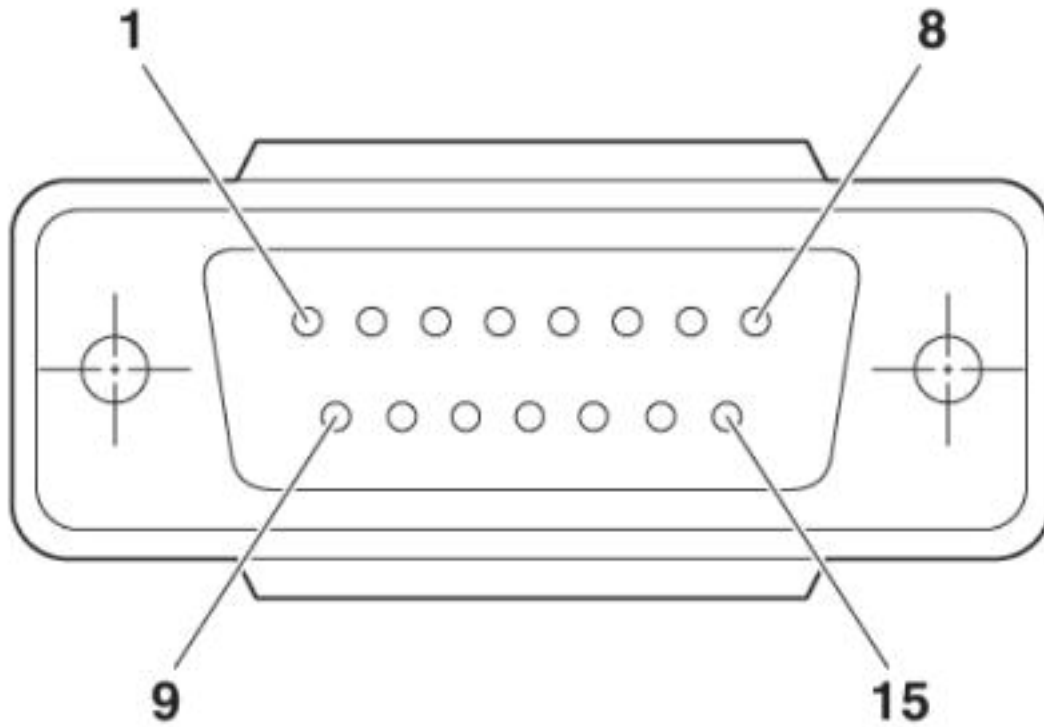

## D-SUB cable - VS-15-DSUB-20-LI-5,0 - 1656288

Schematic diagram

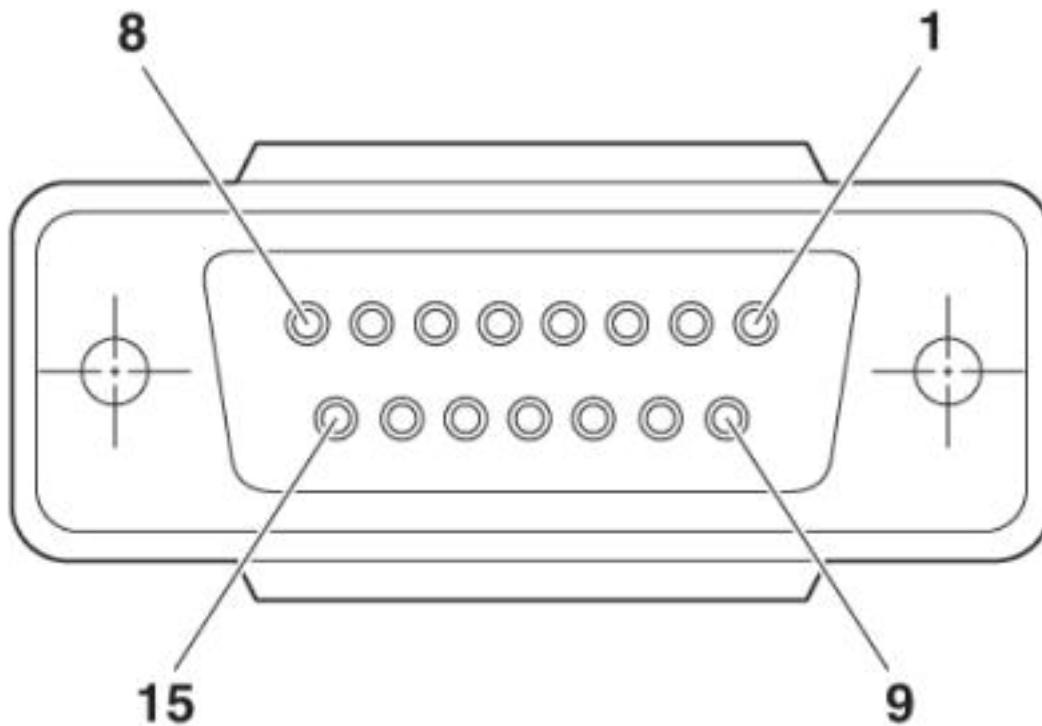

© Phoenix Contact 2013 - all rights reserved  
<http://www.phoenixcontact.com>