

D-SUB cable - VS-09-DSUB-20-LI-1,0 - 1656233

Please be informed that the data shown in this PDF Document is generated from our Online Catalog. Please find the complete data in the user's documentation. Our General Terms of Use for Downloads are valid (<http://download.phoenixcontact.com>)



Assembled D-SUB cable shielded, 9-pos., stranded (7-wire), cable color RAL 7000 (gray), IP20 degree of protection, head 1 with socket shell 1 and straight cable outlet, head 2 with pin shell 1 and straight cable outlet, length: 1 m

Key commercial data

package_quantity	1
GTIN	4046356029711

Technical data

Mechanical characteristics

Number of positions	9
Insertion/withdrawal cycles	≥ 50
Cable exit	Straight
Length of cable	1 m

Ambient conditions

Ambient temperature (operation)	0 °C ... 70 °C
Degree of protection	IP20

Material data

Housing material	PVC
Contact material	Copper alloy
Contact surface material	Gold-plated
Outer sheath, material	PVC

Electrical characteristics

Rated voltage (III/3)	125 V
Rated current	1 A

classifications

eCl@ss

eCl@ss 4.0	27060306
eCl@ss 4.1	27060306
eCl@ss 5.0	27061801
eCl@ss 5.1	27061801
eCl@ss 6.0	27061801

D-SUB cable - VS-09-DSUB-20-LI-1,0 - 1656233

classifications

eCl@ss

eCl@ss 7.0	27061801
eCl@ss 8.0	27061801

ETIM

ETIM 2.0	EC000830
ETIM 3.0	EC001855
ETIM 4.0	EC001855
ETIM 5.0	EC001855

UNSPSC

UNSPSC 6.01	31261501
UNSPSC 7.0901	31261501
UNSPSC 11	31261501
UNSPSC 12.01	31261501
UNSPSC 13.2	31261501

Drawings

Dimensioned drawing

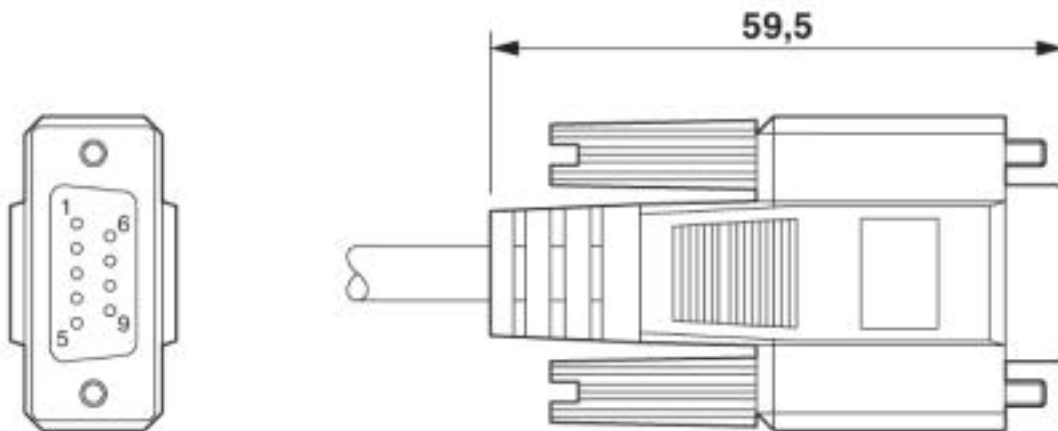

D-SUB cable - VS-09-DSUB-20-LI-1,0 - 1656233

Dimensioned drawing

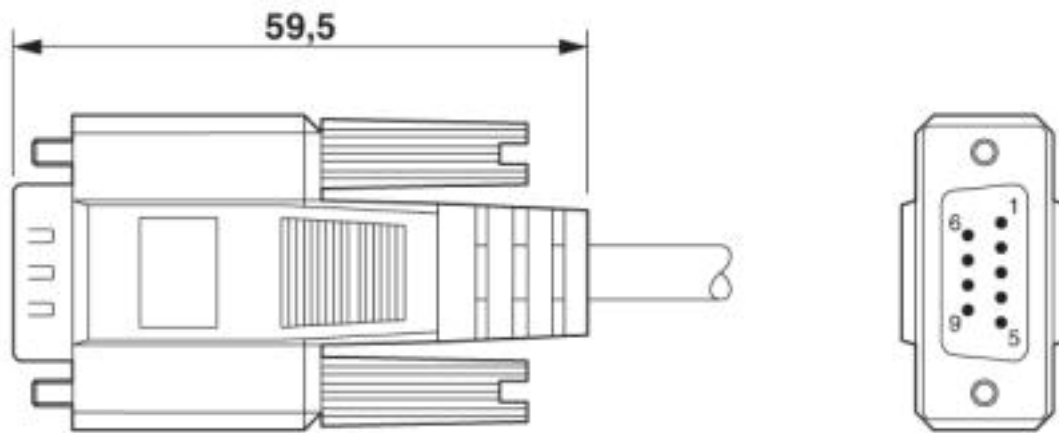

Circuit diagram



D-SUB cable - VS-09-DSUB-20-LI-1,0 - 1656233

Schematic diagram

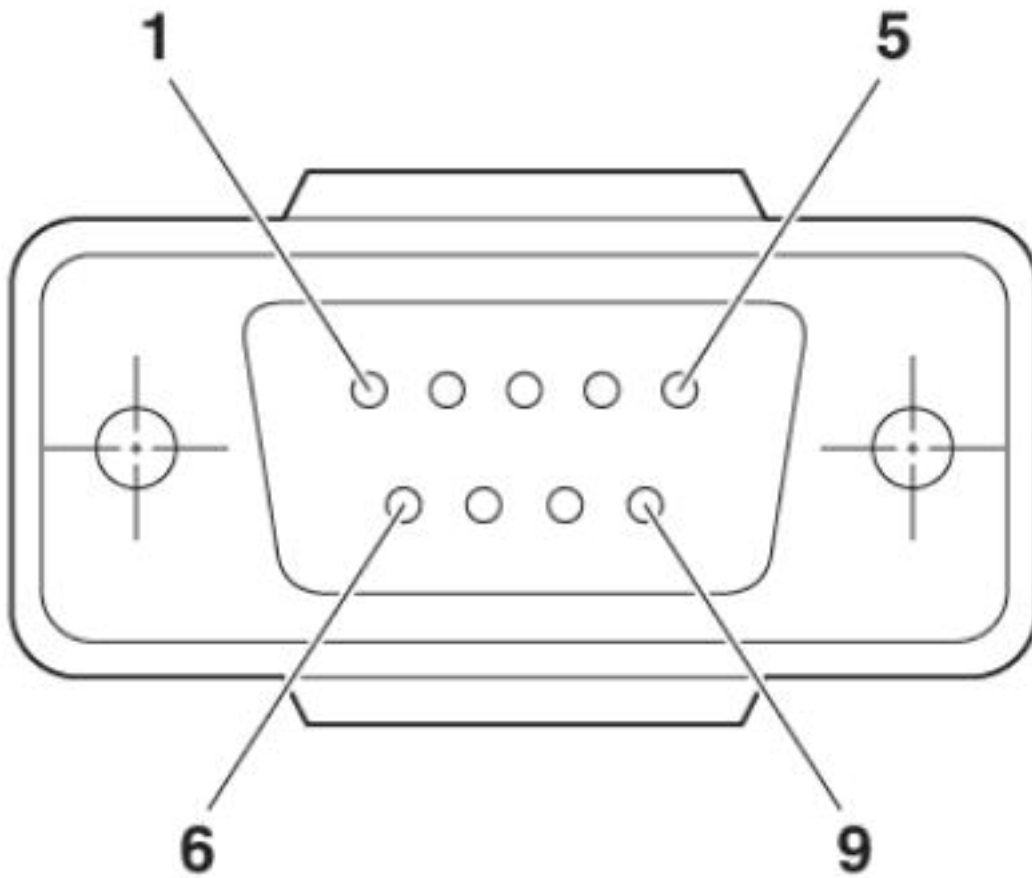

D-SUB cable - VS-09-DSUB-20-LI-1,0 - 1656233

Schematic diagram

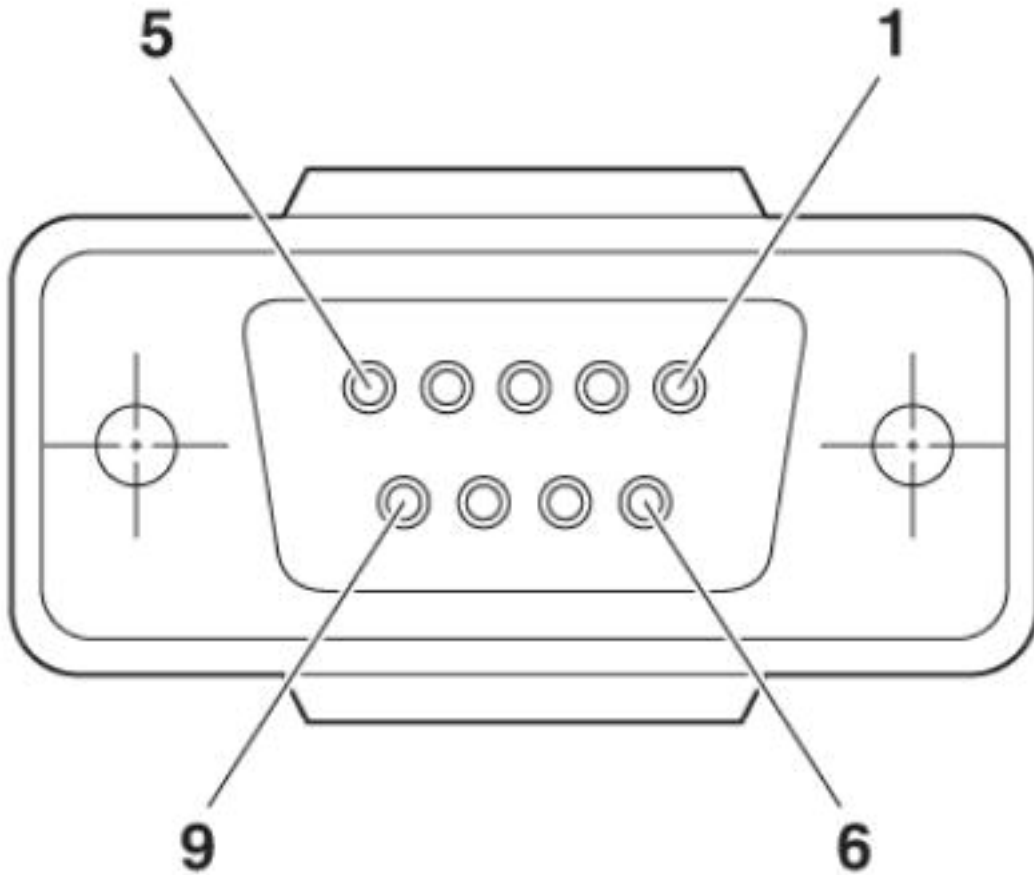

© Phoenix Contact 2013 - all rights reserved
<http://www.phoenixcontact.com>