

Ferrule - AI 6 -12 GN - 3200108

Please be informed that the data shown in this PDF Document is generated from our Online Catalog. Please find the complete data in the user's documentation. Our General Terms of Use for Downloads are valid (<http://download.phoenixcontact.com>)



Ferrule, Length: 20 mm, Color: green

The figure shows the version AI 0,75-8 GY

Product Features

- The metal sleeves are made from soft tin-plated electrolytic copper
- In terms of dimensions, these ferrules conform to DIN 46228-4: 1990-09
- The color code of the plastic insulating collar is based on the French standard NF C 63-023: 1994-02

Key commercial data

package_quantity	100
GTIN	4017918093754

Technical data

Dimensions

Length (b)	20 mm
Sleeve length	12 mm
Inner dimension of the insulating collar (d)	6.2 mm
Ferrule diameter	3.5 mm
Insulating collar thickness	0.3 mm
Sleeve wall thickness	0.2 mm

Ambient conditions

Short-term temperature	120 °C
Max. permanent temperature	105 °C

General

Color	green
Components	free from silicone and halogen
Inflammability class according to UL 94	HB
Material	E-CU

classifications

eCI@ss

Ferrule - Al 6 -12 GN - 3200108

classifications

eCl@ss

eCl@ss 4.0	27060701
eCl@ss 4.1	27060701
eCl@ss 5.0	27400201
eCl@ss 5.1	27400201
eCl@ss 6.0	27400201
eCl@ss 7.0	27400201
eCl@ss 8.0	27400201

ETIM

ETIM 2.0	EC000005
ETIM 3.0	EC000005
ETIM 4.0	EC000005
ETIM 5.0	EC000005

UNSPSC

UNSPSC 6.01	30212109
UNSPSC 7.0901	27121703
UNSPSC 11	27121703
UNSPSC 12.01	27121703
UNSPSC 13.2	27121703

approvals

CSA / CSAus / cCSAus /

Approval details

	
Nominal voltage UN	
Nominal current IN	
mm ² /AWG/kcmil	

CSAus	
Nominal voltage UN	
Nominal current IN	
mm ² /AWG/kcmil	

cCSAus

Ferrule - Al 6 -12 GN - 3200108

Drawings

Dimensioned drawing

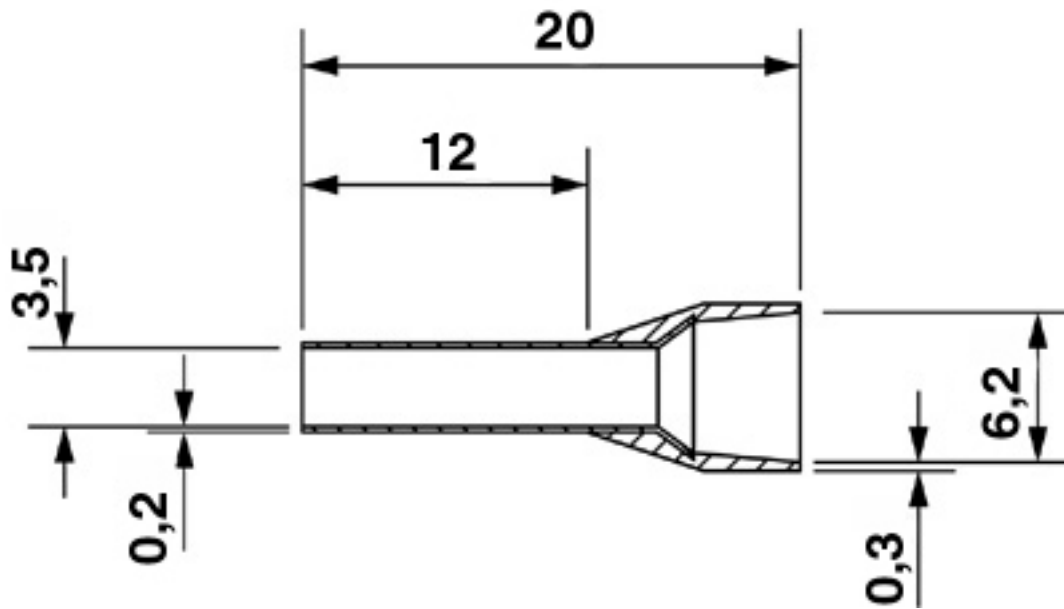

© Phoenix Contact 2013 - all rights reserved
<http://www.phoenixcontact.com>