

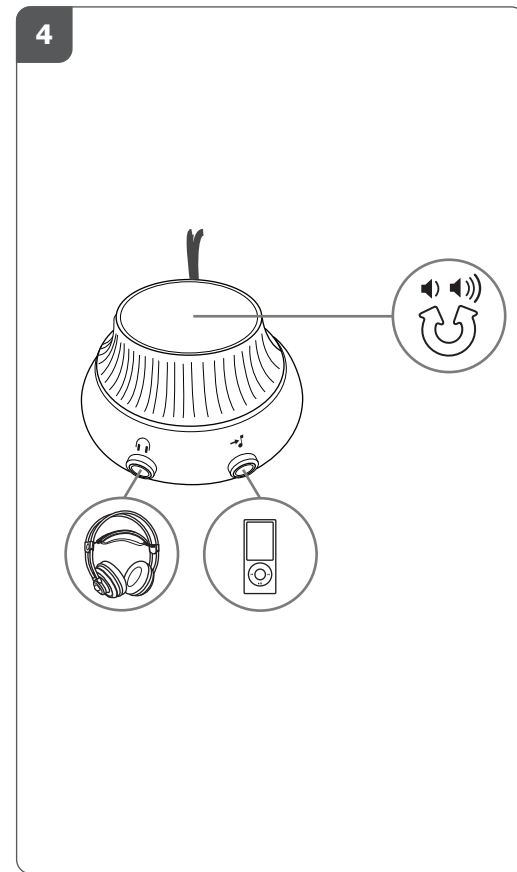

Quick Installation Guide

Tytan 2.1 Subwoofer Speaker set
with Bluetooth

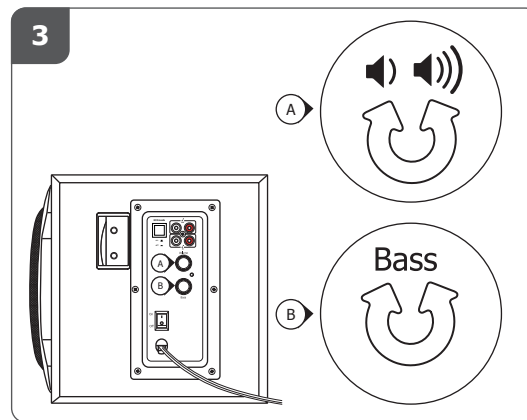
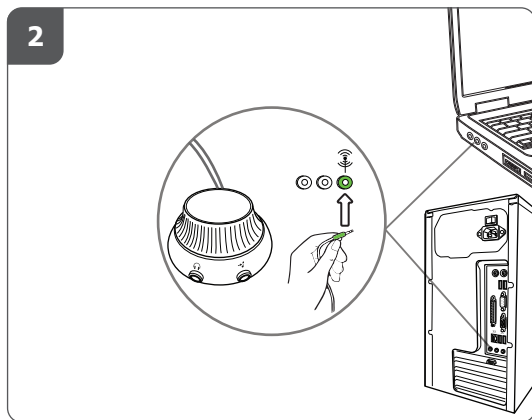
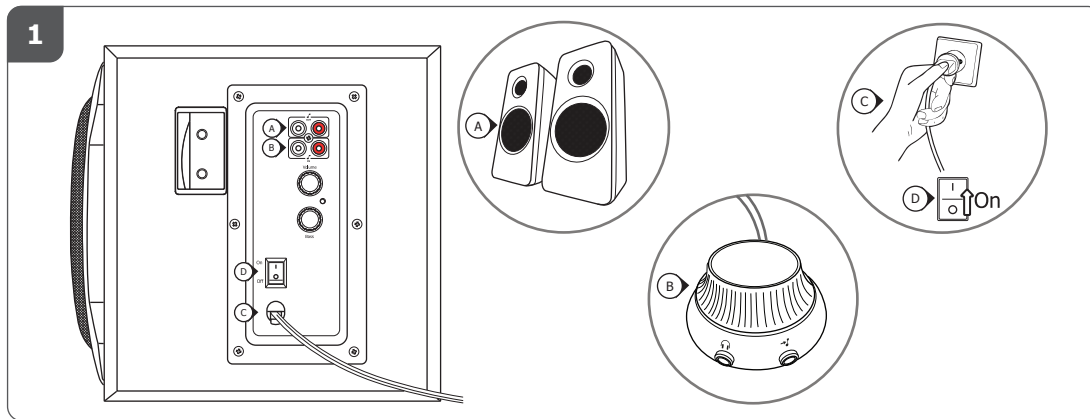

5a

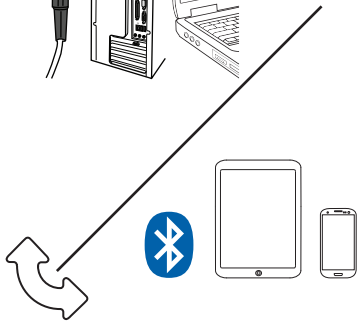
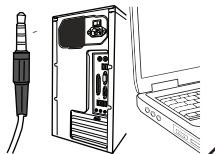
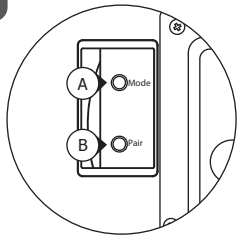

5b

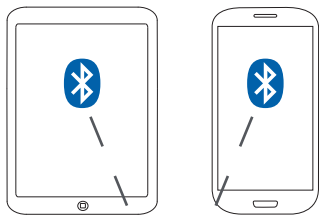
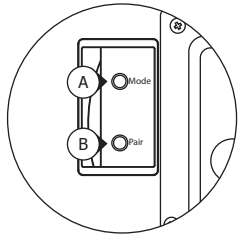

Trust SPK-05

?



ECO mode

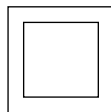

on



off



Frequently asked questions

www.trust.com/19367/faq