

KA03

ILLUSTRATED ASSEMBLY MANUAL HKA03IP'1

Motor & Power shield Arduino®



velleman®
projects



Power shield that can drive: relays, solenoids, DC and stepper motors

Features

- For use with Arduino Due™, Arduino Uno™, Arduino Mega™
- Based on L298P dual full bridge driver IC
- Outputs: up to 2 DC motors or 1 bipolar stepper motor
- Power supply: external power or power from Arduino board

Specifications

- Power supply: 7..46VDC
- Max current: 2A
- Dimensions: 68 x 53mm / 2.67 x 2.08"



Search product

Search Product

United Kingdom - English (UK) [Change](#)

Velleman Projects Newsletter

Are you an electronic enthusiast or simply interested in our kits, mini-kits, modules and instruments?

Subscribe to our Newsletter and receive every month the latest news, new products & updates on Velleman Projects.

You will receive an email. Click on the link in that email to confirm your subscription.

Email:

Do you want to unsubscribe? Click on the 'unsubscribe' link in the footer of the last received newsletter from Velleman Projects.

NEW FM1253 LED CUBE

CubeAnimator software available for download [here!](#)

Posted on 04-06-12

[Read more...](#)

Navigation

- + Main page
- + Products
- + Sales outlets
- + Support
- + Publications
- + Jobs
- + About us

NEW! Projects

- velleman.eu
- Supporter.eu
- panel.eu
- vellemanprojects.com
- vellemanproject.com
- forum.velleman.eu

Advertisements

WINNIX / WINNIX Android Application



Subscribing our newsletter?, visit www.vellemanprojects.eu

velleman projects

INSTRUMENTS

ANALYZER KIT

Support Forum (ENFR)

Velleman Projects

Home | Register

16 members | 61 topics | 1000+ posts

View unanswered posts | View active topics

Search topics

Forum	Topics	Posts	Last post
General			
French video, Regenerators de France Topic first - 1 & 2 in an order list Moderation: velleman Support	1	1	Wed May 09, 2012 12:44 pm View topic
Forum Administration Velleman On-line Home Automation System (OSHA) Kit Moderation: velleman Support	1	1	Fri May 11, 2012 12:02 pm View topic
Software			
Velleman Home Automation General forum for our new Velleman Home Automation System (OSHA) Kit Moderation: velleman Support	404	2072	Tue May 15, 2012 12:10 pm View topic
Kits (Outstanding projects - Projects in progress)			
General For other topics, general tips and tricks, new ideas Moderation: velleman Support	176	428	Wed May 09, 2012 12:07 pm View topic
Audio kit (Project) An audio related projects, amplifiers, radio amplifiers Moderation: velleman Support	107	2400	Fri May 14, 2012 6:40 am View topic
PC Related Projects The projects that are connected to the PC via interface cards Moderation: velleman Support	1428	4548	Fri May 11, 2012 12:04 pm View topic
Microcontroller Programmer - Experimenting Projects Microcontroller projects, PIC programming, Arduino stuff Moderation: velleman Support	467	1744	Tue May 15, 2012 12:07 pm View topic
Remote control (RC) All about our long related projects from regular remote to programmable links Moderation: velleman Support	281	806	Fri May 11, 2012 6:40 am View topic
Remote Projects Remotely related projects, from light drivers to remote control Moderation: velleman Support	434	1282	Fri May 11, 2012 12:08 pm View topic



Participate our Velleman Projects Forum



Velleman N.V.
Legen Heirweg 33
9890 Gavere
(België)

assembly hints

1. Assembly (Skipping this can lead to troubles !)

Ok, so we have your attention. These hints will help you to make this project successful. Read them carefully.



1.1 Make sure you have the right tools:

- A good quality soldering iron (25-40W) with a small tip.
- Wipe it often on a wet sponge or cloth, to keep it clean; then apply solder to the tip, to give it a wet look. This is called 'thinning' and will protect the tip, and enables you to make good connections. When solder rolls off the tip, it needs cleaning.
- Thin rosin-core solder. Do not use any flux or grease.
- A diagonal cutter to trim excess wires. To avoid injury when cutting excess leads, hold the lead so they cannot fly towards the eyes.
- Needle nose pliers, for bending leads, or to hold components in place.
- Small blade and Phillips screwdrivers. A basic range is fine.



For some projects, a basic multi-meter is required, or might be handy



1.2 Assembly Hints :

- Make sure the skill level matches your experience, to avoid disappointments.
- Follow the instructions carefully. Read and understand the entire step before you perform each operation.
- Perform the assembly in the correct order as stated in this manual
- Position all parts on the PCB (Printed Circuit Board) as shown on the drawings.
- Values on the circuit diagram are subject to changes, the values in this assembly guide are correct*
- Use the check-boxes to mark your progress.
- Please read the included information on safety and customer service

* Typographical inaccuracies excluded. Always look for possible last minute manual updates, indicated as 'NOTE' on a separate leaflet.

1.3 Soldering Hints :

1. Mount the component against the PCB surface and carefully solder the leads



2. Make sure the solder joints are cone-shaped and shiny



3. Trim excess leads as close as possible to the solder joint



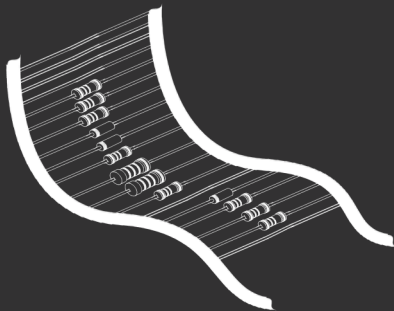

REMOVE THEM FROM THE TAPE ONE AT A TIME !

Included in
this kit

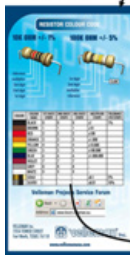

2. RESISTOR

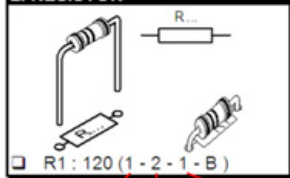

COLOUR	COLOUR NAME	1ST DIGIT/ STRIPE	2ND DIGIT/ STRIPE	3RD DIGIT/ STRIPE	MULTIPLIER STRIPE	TOLERANCE 4TH
Black	BLACK	0	0	0	x1	1%
Brown	BROWN	1	1	1	x10	
Red	RED	2	2	2	x100	
Orange	ORANGE	3	3	3	x1.000	
Yellow	YELLOW	4	4	4	x10.000	
Green	GREEN	5	5	5	x100.000	
Blue	BLUE	6	6	6	x1.000.000	

DO NOT BLINDLY FOLLOW THE ORDER OF THE COMPONENTS ONTO THE TAPE. ALWAYS CHECK THEIR VALUE ON THE PARTS LIST!

I CONSTRUCTION

1 Resistors

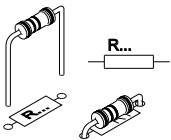

- R1: 4K7 (4 - 7 - 2 - B)
- R2: 10K (1 - 0 - 3 - B)
- R3: 4K7 (4 - 7 - 2 - B)
- R4: 4K7 (4 - 7 - 2 - B)
- R5: 10K (1 - 0 - 3 - B)
- R6: 4K7 (4 - 7 - 2 - B)
- R7: 1K (1 - 0 - 2 - B)
- R8: 1K (1 - 0 - 2 - B)
- R9: 100K (1 - 0 - 4 - B)
- R10: 10K (1 - 0 - 3 - B)

2 Ceramic capacitors

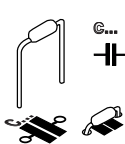

- C1: 100nF (104)

3 Shottky diode



- D1: 1N5819
- D2: 1N5819
- D3: 1N5819
- D4: 1N5819
- D5: 1N5819
- D6: 1N5819
- D7: 1N5819
- D8: 1N5819

4 Transistors



- T1: BC547B
- T2: BC547B

5 Male header

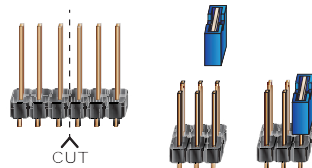

- SK8... SK10: 2x3pin



CUT

- 3pin



EXTERNAL
power (max. 50V)



INTERNAL
power from Arduino
Max. 2A



6 Female header

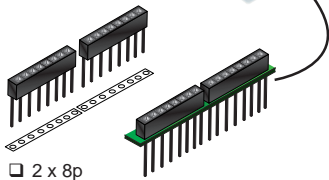
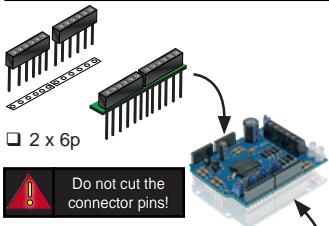

7 LED's

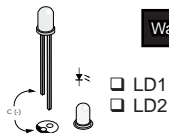

8 Terminal blocks

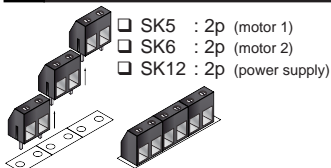

10 Dual Full Bridge driver

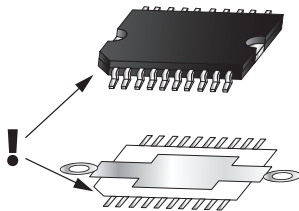

□ IC1: L298P

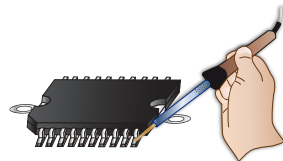
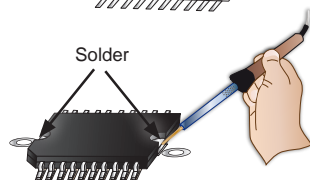

9 Electrolytic capacitors

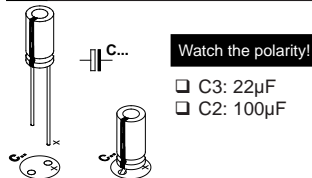

II CONNECTION DIAGRAM

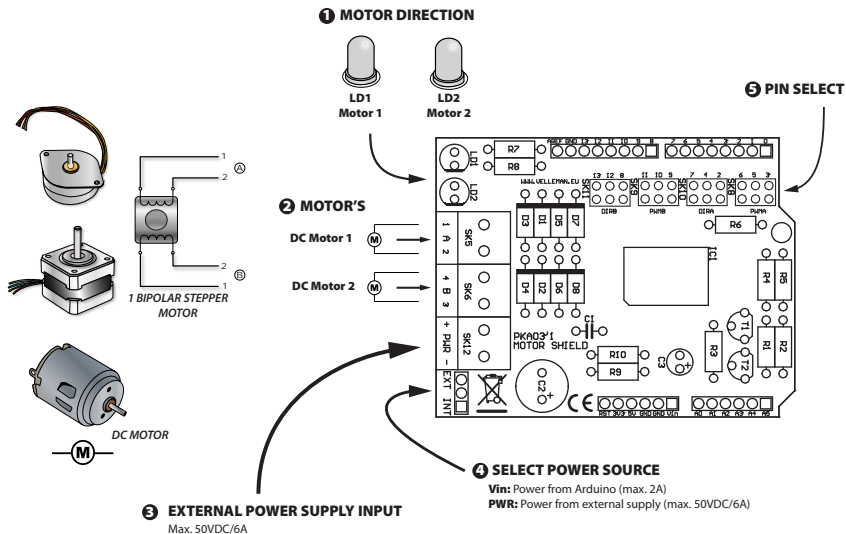

DOWNLOAD SAMPLE CODE FROM KA03 PAGE ON WWW.VELLEMAN.BE

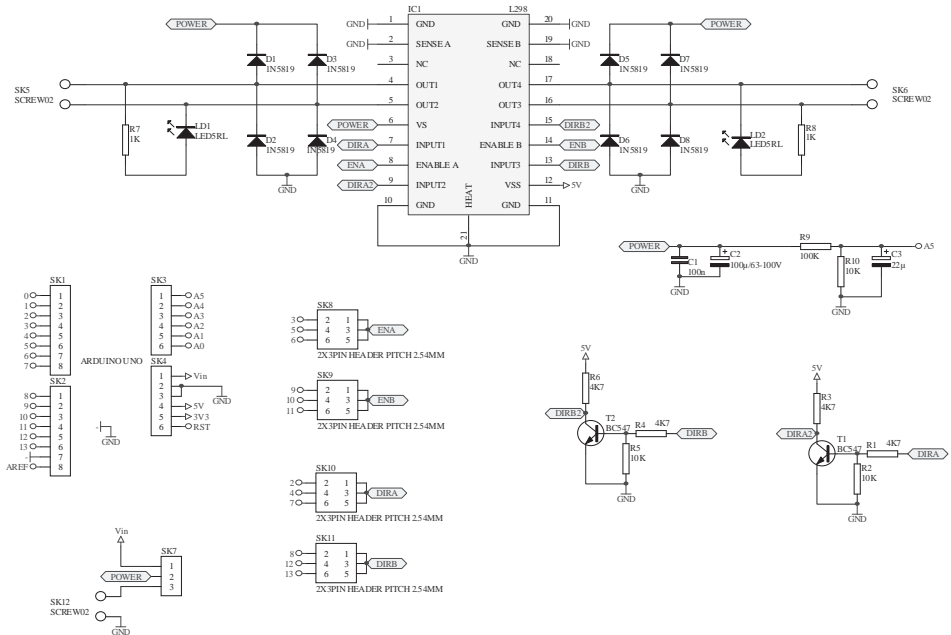

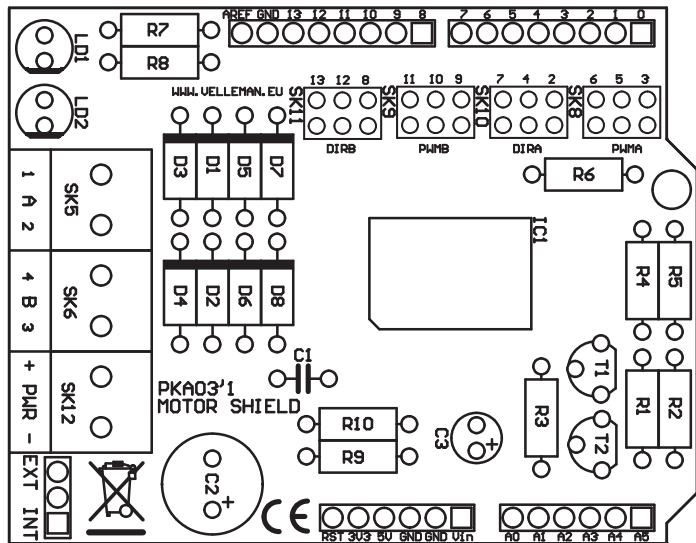

Leds and how to use them

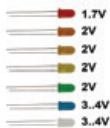

Leds feature a specific voltage drop, depending on type and colour. Check the datasheet for exact voltage drop and rated current !

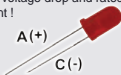

Never connect leds in parallel

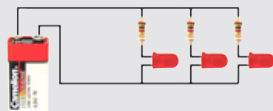
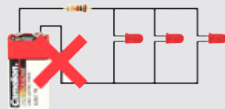

How to Calculate the series resistor:

Example: operate a red led (1.7V) on a 9Vdc source.

Required led current for full brightness: 5mA (this can be found in the datasheet of the led)

$$\frac{\text{Supply voltage (V) - led voltage (V)}}{\text{required current (A)}} = \text{series resistance (ohms)}$$



$$\frac{9V - 1.7V}{0.005A} = 1460 \text{ ohm}$$

closest value :
use a 1k5 resistor

Required resistor power handling=
voltage over resistor x current passed trough resistor



$$(9V - 1.7V) \times 0.005A = 0.036W$$

a standard 1/4W resistor
will do the job

LEDs in series:

Example: 3 x red led (1.7V) on 9V battery

Required led current for full brightness: 5mA
(this can be found in the datasheet of the led)

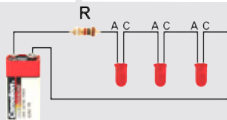

$$\frac{\text{Supply voltage (V) - (number of leds x led voltage (V))}}{\text{required current (A)}} = \text{series resistance (ohms)}$$



$$\frac{9V - (3 \times 1.7V)}{0.005A} = 780 \text{ ohm}$$

use an
820 ohm resistor

open collector outputs

An open collector output can be compared to a switch which switches to ground when operated

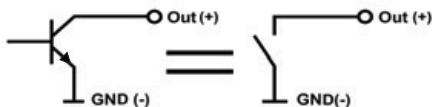

Example: How to switch an LED by means of an open collector output

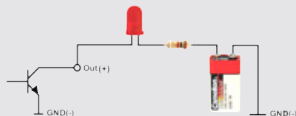



The new Velleman Projects catalogue is
now available. Download your copy here:
www.vellemanprojects.eu



Modifications and typographical errors reserved - © Velleman nv. HKA03'IP (Rev.1)
Velleman NV, Legen Heirweg 33 - 9890 Gavere.