

Installation Guide

Smart-UPS[™] C 1000/1500 VA 120/230 Vac 2000/3000 VA 230 Vac Rack-Mount 2U

Important Safety Messages

Read the instructions carefully to become familiar with the equipment before trying to install, operate, service or maintain it. The following special messages may appear throughout this manual or on the equipment to warn of potential hazards or to call attention to information that clarifies or simplifies a procedure.



The addition of this symbol to a Caution product safety label indicates that a hazard exists that can result in injury and product damage if the instructions are not followed.

The following safety messages may appear throughout this manual to warn of potential hazards.

 CAUTION
CAUTION indicates a potentially hazardous situation which, if not avoided, can result in equipment damage and minor or moderate injury.

CAUTION
CAUTION indicates a potentially hazardous situation which, if not avoided, can result in equipment damage.

Safety and General Information

Inspect the package contents upon receipt. Notify the carrier and dealer if there is any damage.

Read the Safety Guide supplied with this unit before installing the UPS.

- Adhere to all local and national electrical codes.
- This UPS is intended for indoor use only.
- Do not operate this UPS in direct sunlight, in contact with fluids, or where there is excessive dust or humidity.
- Be sure the air vents on the UPS are not blocked. Allow adequate space for proper ventilation.
- The battery typically lasts for two to five years. Environmental factors impact battery life. Elevated ambient temperatures, poor quality utility power, and frequent short duration discharges will shorten battery life.
- Connect the UPS power cable directly to a wall outlet. Do not use surge protectors or extension cords.
- The batteries are heavy. Remove the batteries prior to installing the UPS in a rack.

 WARNING
This is a category C2 UPS product.
In a residential environment, this product may cause radio interference, in which case the user may be required to take additional measures.

Inventory

All models



(2)

Documentation CD x 1
PowerChute Software CD x 1

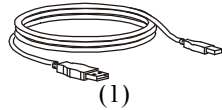

(1)

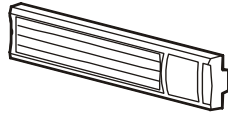

(1)



(2)



(4)



(1)

Installation Guide

1000/1500/2000/3000 VA 230 Vac models

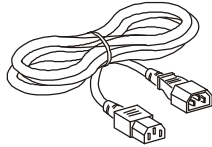

(2)

1000VA 120/230 Vac models

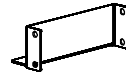

(2)



(4)



(2)



(2)



(2)

2000/3000 VA 230 Vac models

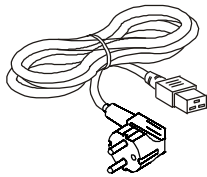

(1)

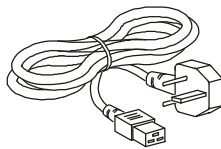

(1)

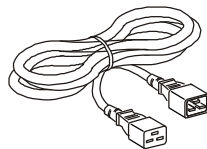

(1)

Product Overview

Rear Panel features

- ① UPS input
- ② Circuit breaker/Overload protection
- ③ Chassis ground screw
- ④ Outlets
- ⑤ USB port
- ⑥ Serial data port

1000 VA 120 Vac

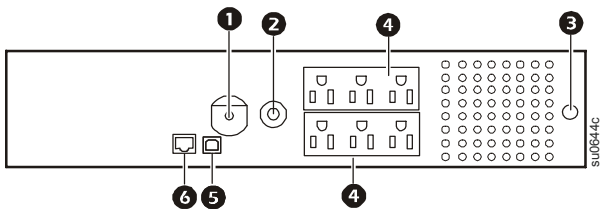

1000 VA 230 Vac

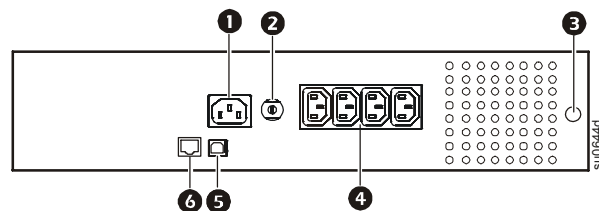

1500 VA 120 Vac

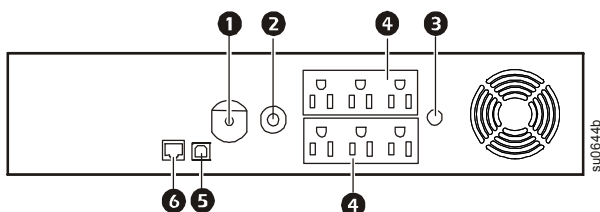

1500 VA 230 Vac

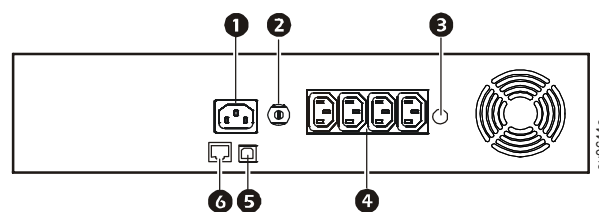

- ❶ UPS input
- ❷ Circuit breaker/Overload protection
- ❸ Chassis ground screw

- ❹ Outlets
- ❺ USB port
- ❻ Serial data port

2000 VA 230 Vac

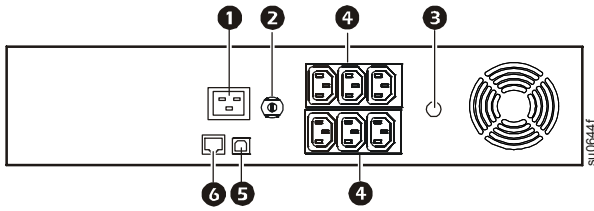

3000 VA 230 Vac

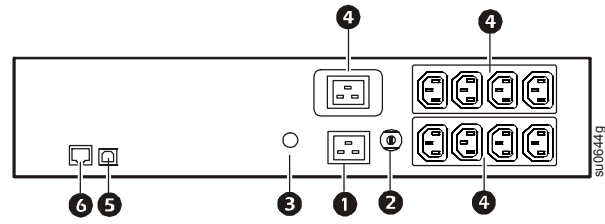

Front panel features

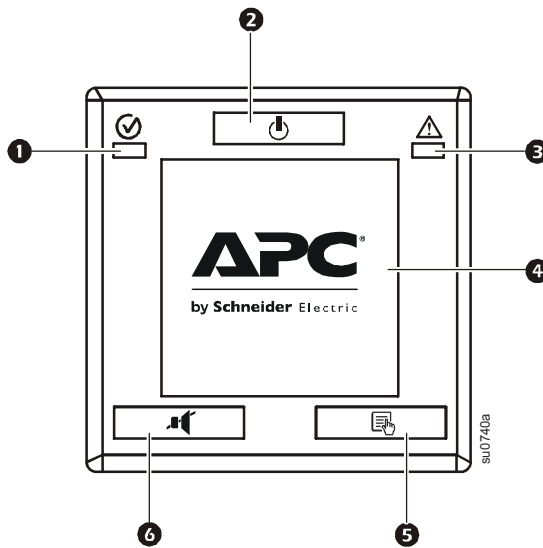

- ❶ Online/On Battery LED
- ❷ POWER ON/OFF button
- ❸ *120 Vac models only:*
Site Wiring Fault/System Fault LED
- ❹ Display interface
- ❺ DISPLAY button
- ❻ MUTE button

Installation

⚠ CAUTION
DAMAGE TO EQUIPMENT OR PERSONNEL <ul style="list-style-type: none"> The equipment is heavy. Always practice safe lifting techniques adequate for the weight of the equipment. The combined weight of the UPS and the battery is heavy. Remove the battery before installing the UPS in a rack. Failure to follow these instructions can result in equipment damage and minor or moderate injury

CAUTION
DAMAGE TO EQUIPMENT <ul style="list-style-type: none"> When installing equipment in a rack, always install peripheral equipment at the bottom of the rack. The UPS should always be installed above peripheral equipment in rack or stack configurations. Always connect the UPS to a grounded outlet. Failure to follow these instructions can result in equipment damage

1000 VA 120/230 Vac Models

1

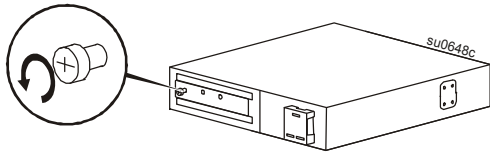

2

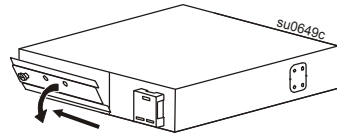

3

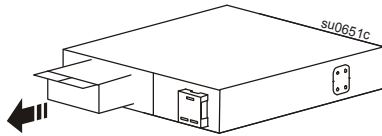

4

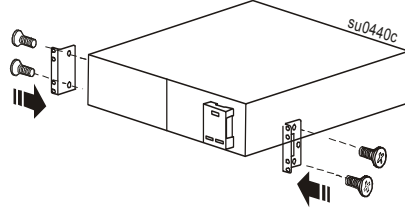

Two post rack installation

1

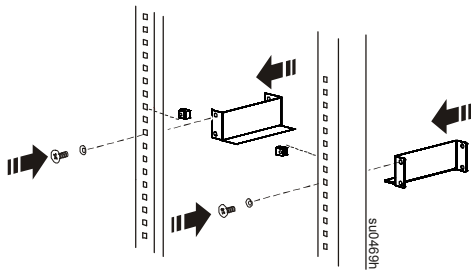

2

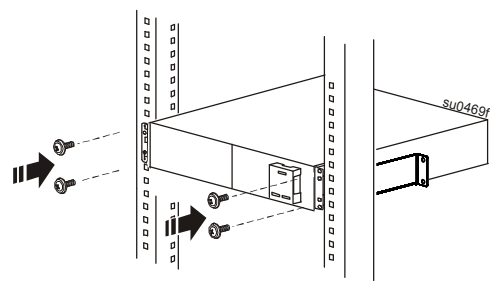

Four post rack installation

1

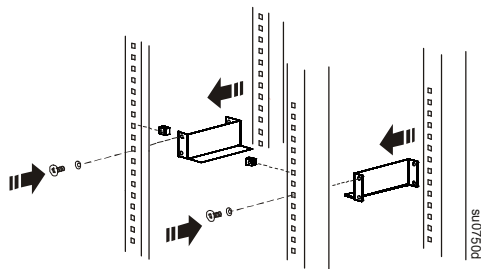

2

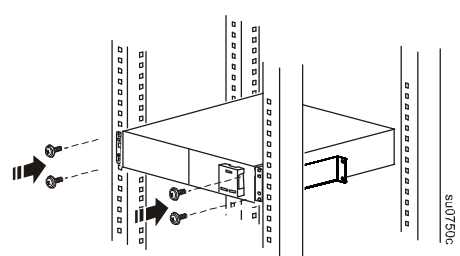

Install the battery

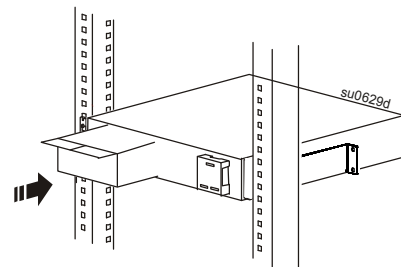
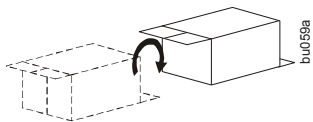

Secure the battery compartment door

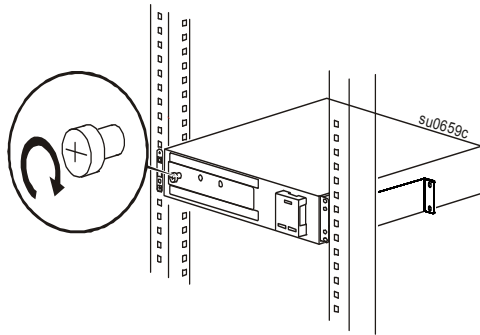

Install the bezel

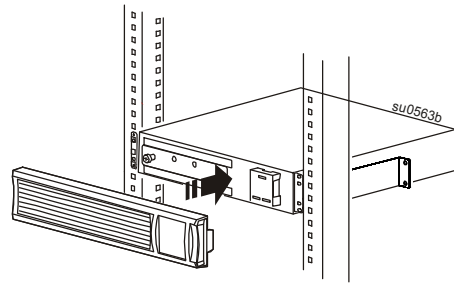

1500 VA 120/230 Vac and 2000 VA 230 Vac Models

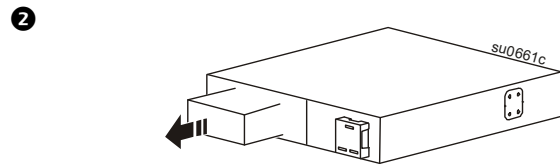
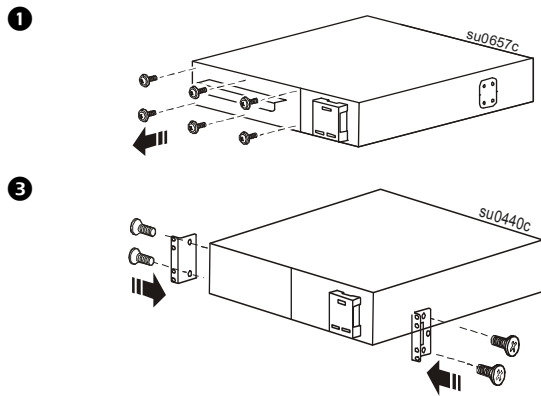

Two post rack installation

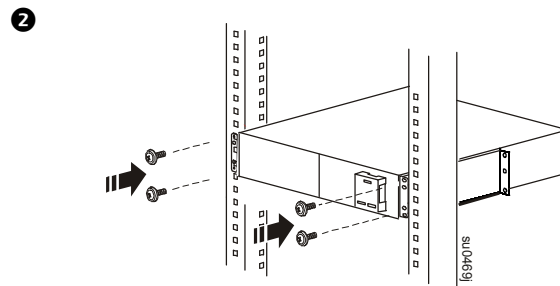
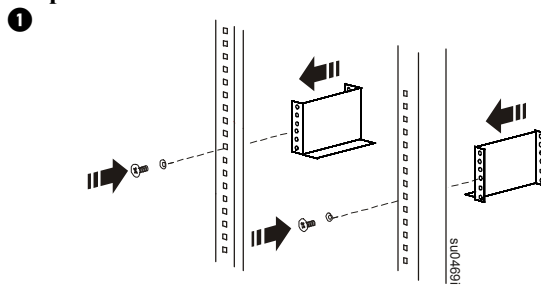

Four post rack installation

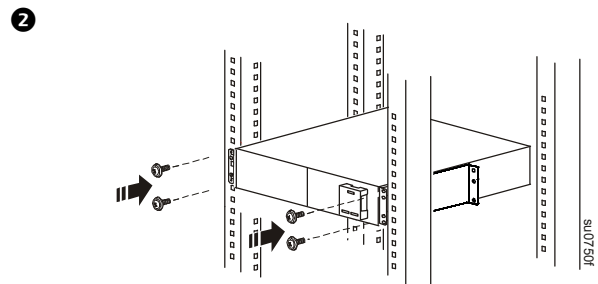
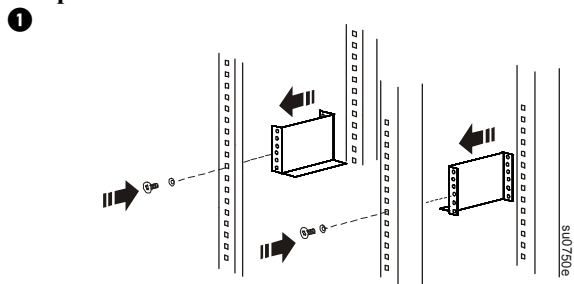

Install the battery

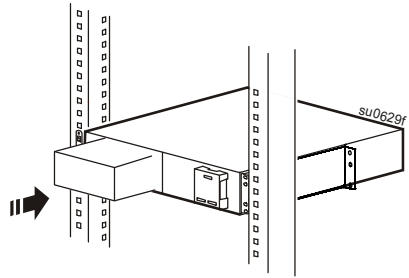

Connect the battery

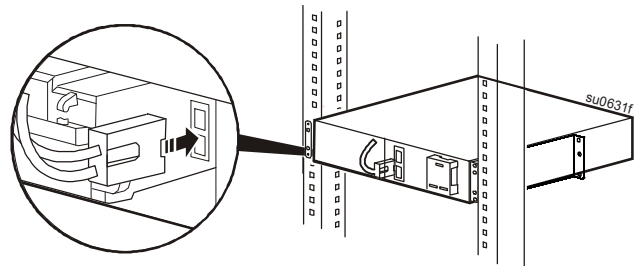

Secure the battery compartment door

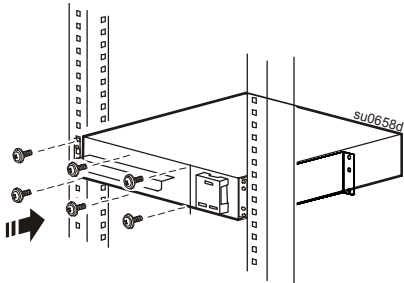

Install the bezel

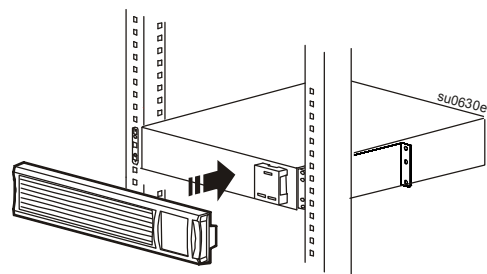

Connect equipment to the UPS and connect the UPS to AC power

CAUTION

RISK OF EQUIPMENT DAMAGE

- Adhere to all local and national electrical codes.
- Wiring should be performed by qualified electrician.
- Always connect the UPS to a grounded outlet.

Failure to follow these instructions can result in equipment damage

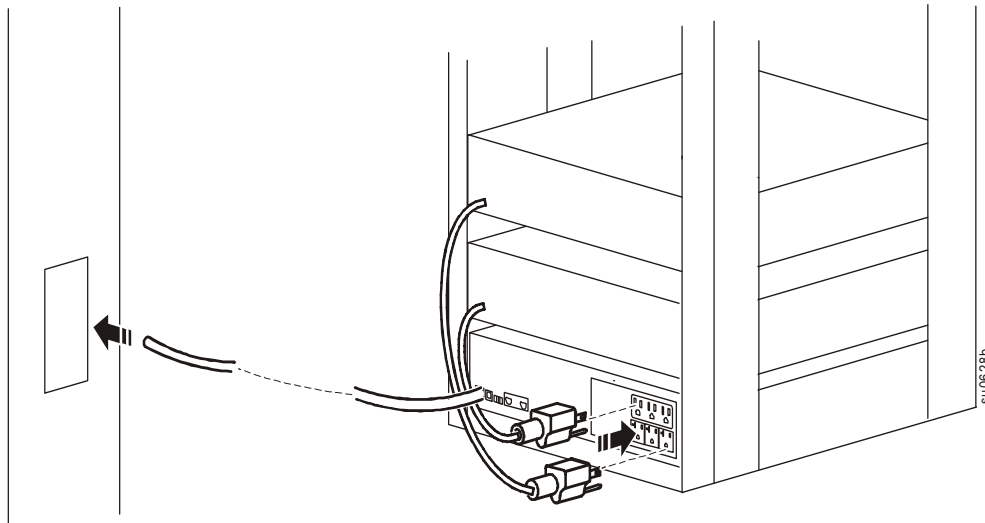

Select models are ENERGY STAR® qualified.

For more information go to www.apc.com/site/recycle/index.cfm/energy-efficiency/energy-star/.