

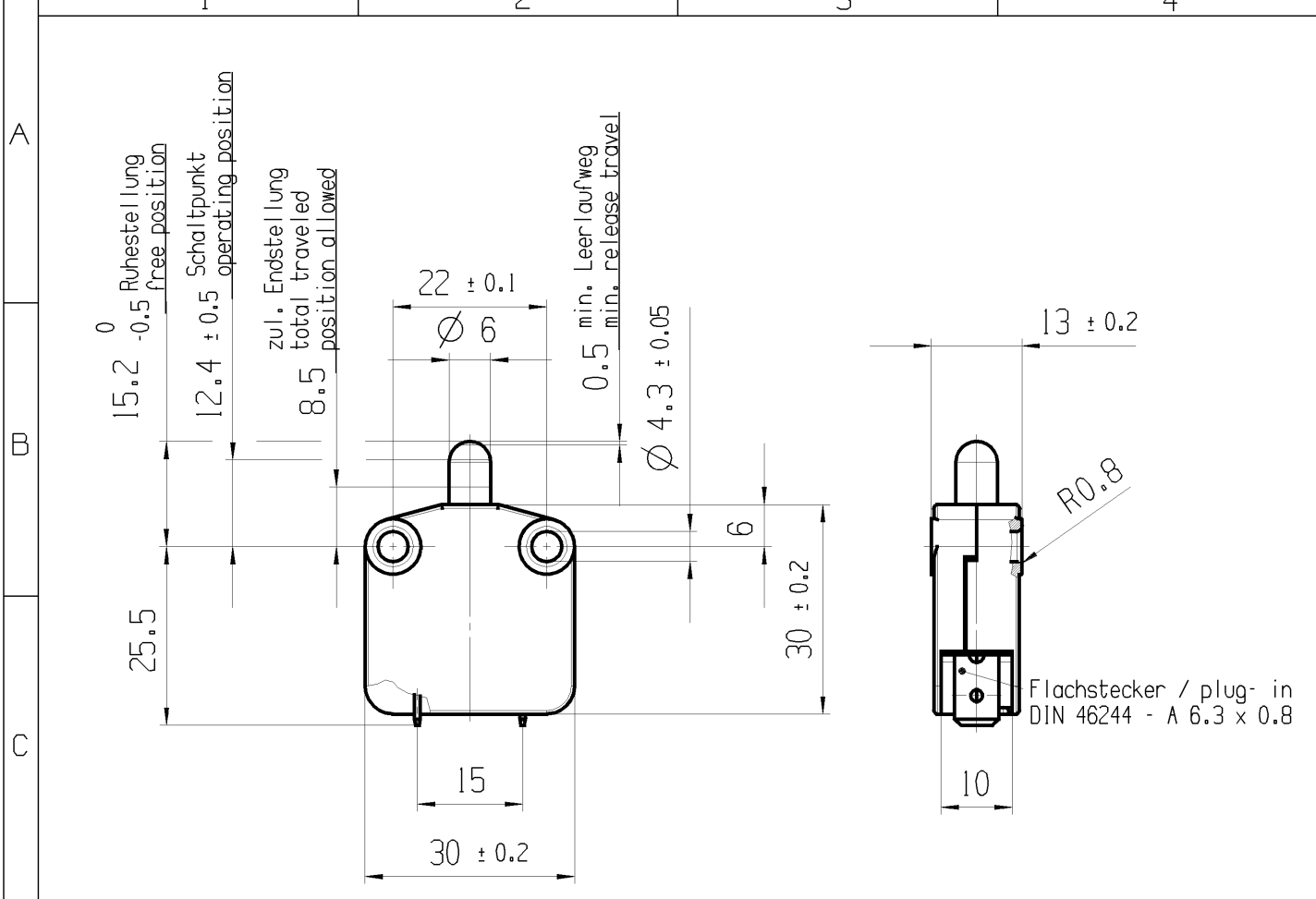



© THIS DRAWING IS THE EXCLUSIVE PROPERTY OF MARQUARDT GMBH. WITHOUT THEIR CONSENT IT MAY NOT BE REPRODUCED OR GIVEN TO THIRD PARTIES.

VERTRAULICH CONFIDENTIAL

© Alle Rechte bei Marquardt GmbH, auch fuer den Fall von Schutzrechtsmeldungen. Jede Verfuegungsbefugnis, wie Kopier- und Weitergaberecht, bei uns.



Aufschrift
Marking
MARQUARDT 
1117.
16(6)/400 ~ T85
 05
12A 125 - 250 V AC
1/6 HP 125 V AC
1/2 HP 250 V AC
R84 
T.-Nr. 6577900

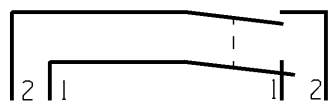



Oeffner 1-polig
Schalt-Betaetigungskraft 3.5N ± 0.5N
Differenzweg (Weg zwischen Schaltpunkt und Rueckschaltpunkt) max. 2.3

SPNC
actuating force 3.5N ± 0.5N
movement differential (movement between operating position and release position) max. 2.3

Auf Verpackung / on box : T.-Nr.6577900

Rd ≤ 100 mΩ bei/at I > 1A

fuer Form und Lage FOR SHAPE AND LOC.	☉ =	Allgemeintoleranzen UNTOLERANCED DIMENSIONS				Pause COPY	Blatt SHEET 01		TYP K	Zeichn./DRAWING NO. 11170206	Index b
		PROJEKTION	Abmasse und Nennmassbereiche Angaben in mm	Laenge LENGTH	Radien RADII		Original Din A4	Masstab SCALE 1:1			
fuer Winkel FOR ANGLE ± 2			ALL DIMENSIONS ARE IN MILLIMETRES	0-6 ± 0.2 ± 0.2	>6-15 ± 0.4 ±	>15-30 ± 0.4 ±	>30-70 ±	>70-120 ±	>120-200 ±	0 10 20 30mm	GERAETESCHALTER appliance switch
b	47541	15.05.06	BRC	CAD: NX V2.0			Ersatz fuer/REPLACEMENT OF Zg.gl.Nr.v.20.04.05		MARQUARDT 		
a	44287	04.08.05	BRC	gez./DRAWN BY 04.08.05 BRC gepr./CHECKED BY							
Ausg. ISSUE	Aenderung REVISION	gez. DRAWN BY	Ausg. ISSUE	Aenderung REVISION	gez. DRAWN BY						