

IB & IS SERIES

SEALED MOMENTARY PUSHBUTTON SWITCHES

Distinctive features and overview

• **MORE COMPACT**

These new pushbutton switches have a behind-panel depth of only 13 mm and fit into a Ø 13,6 mm (.535) panel cut-out.

The bushing-bezel assembly is of single piece construction.

• **SIMPLIFIED MOUNTING**

The snap-in mounting version meets the user's requirement for easy panel assembly.

The thermoplastic bushing and bezel assembly allows APEM to achieve a 50 % reduction in weight compared to metallic models.

• **SEALED TO IP 67**

The IB and IS pushbutton switches are sealed to IP 67 against immersion. The silicone membrane located beneath the plunger ensures sealing and provides tactile feedback.

D

MODEL STRUCTURE

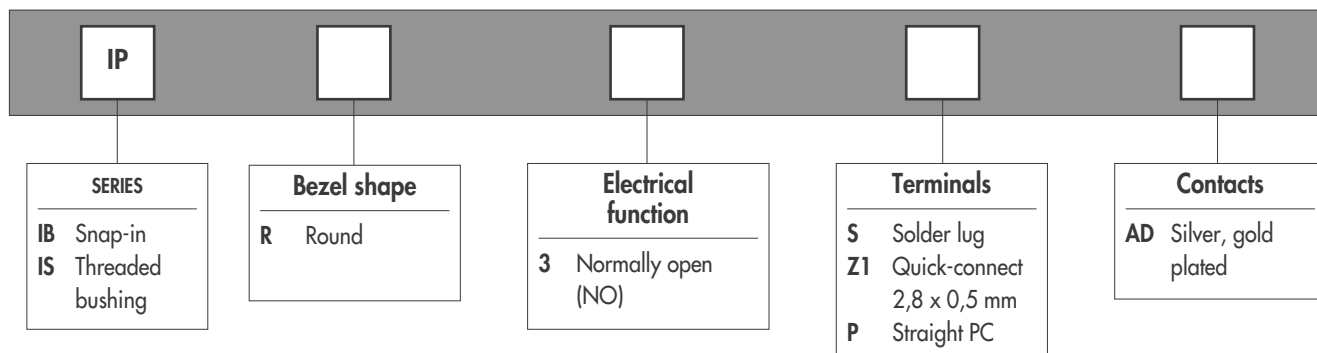

OPTIONS

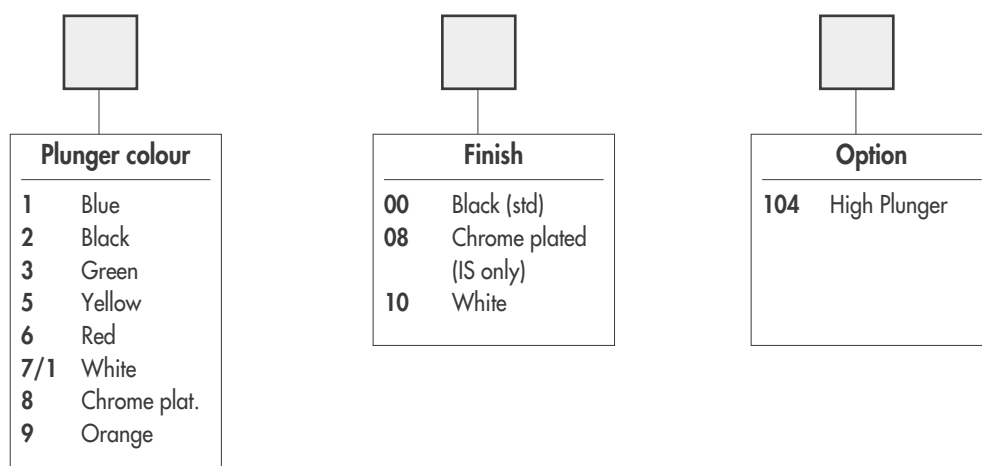

ABOUT THIS SERIES

On the following pages, you will find successively :

- specifications
- model structure of switches and options in the same order as in above chart

Dimensions : first dimensions are in mm while inches are shown as bracketted numbers.



NOTICE : please note that not all combinations of above numbers are available. Refer to the following pages for further information.



A sealing boot is available to protect the switches against frost and sand. It is presented at the end of the series and in section N.



Mounting accessories : Standard hardware supplied : 1 flat seal (IB series) 1 hex nut 14 mm (.551) across flats and 1 flat seal (IS series). The hex nut is presented in section N (part number U166).



Packaging unit : 50 pieces

IB & IS SERIES

SEALED MOMENTARY PUSHBUTTON SWITCHES

Specifications

ENVIRONMENTAL SPECIFICATIONS

- Degree of protection : IP 67
- Shock resistance : 100 g according to IEC 512-4, test 6c
- Vibration resistance : 10-500 Hz - 10 g according to IEC 512-4, test 6d
- Salt spray : IEC 512-6, test 11f
- Operating temperature : -40°C to +85°C

MATERIALS

- Case : thermoplastic UL94-V0
- Plunger : polyamide 6/6
- Bushing/bezel : polyamide 6/6
- Contacts : silver, gold plated
- Terminal seal : epoxy

ELECTRICAL AND GENERAL SPECIFICATIONS

- Max. current/voltage rating with resistive load :
400mA 32VAC - 100mA 50VDC - 125mA 125VAC
- Initial contact resistance : 50 mΩ max.
- Insulation resistance : 1 GΩ min. at 500VDC
- Dielectric strength : 1.000 VAC rms
- Electrical life at full load : 500.000 cycles
- Panel thickness :
 - IB series : 0,8 mm (.031) min. - 1,8 mm (.071) max.
 - IS series : 1,5 mm (.059) min. - 4 mm (.157) max.
- Total travel : 1,5 mm (.059)
- Operating force : 3N +/- 1N
- Contact bounce : 10 ms
- Mechanical life : 1.000.000 cycles
- Torque : 1,5 Nm max. applied to nut
- Soldering : 300°C max. for 3 seconds

D

IB & IS SERIES

SEALED MOMENTARY PUSHBUTTON SWITCHES

Snap-in or with threaded bushing

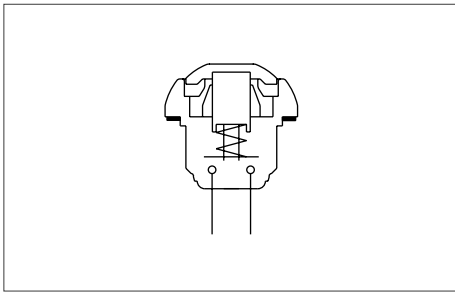

- Eight plunger colours
- Flat plunger top allowing marking
- Antirotation bushing

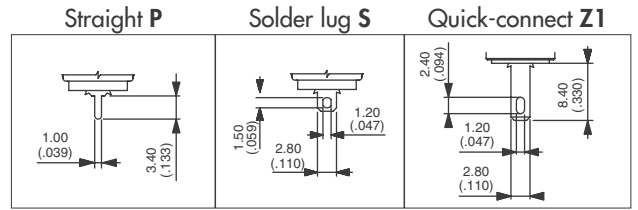

MODEL STRUCTURE

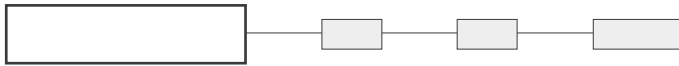

Snap-in mounting - solder lugs

→ Flat

Panel thickness : 0,8 mm to 1,8 mm



IBR3SAD



Normally open

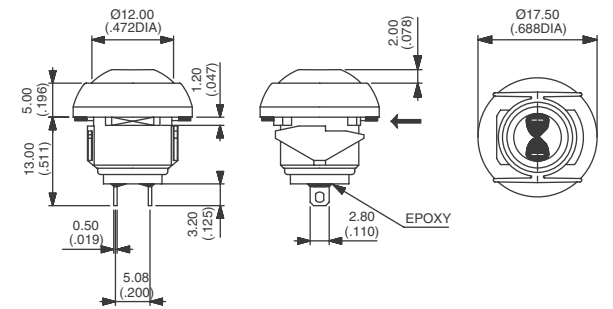

Also available with straight PC : **IBR3PAD** or quick-connect terminals : **IBR3Z1AD**

Mounting by threaded bushing - solder lugs

→ Flat

Panel thickness : 1,5 mm to 4 mm



ISR3SAD



Normally open

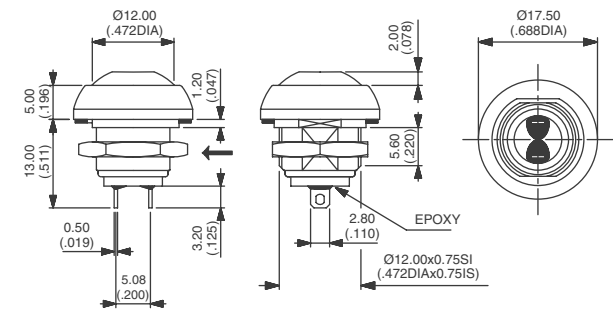

Also available with straight PC : **ISR3PAD** or quick-connect terminals : **ISR3Z1AD**

PLUNGER COLOUR



Plunger marking : consult factory.

1 : blue - 2 : black - 3 : green - 5 : yellow - 6 : red - 7/1 : white - 8 : chrome plated - 9 : orange

BUSHING AND BEZEL FINISH

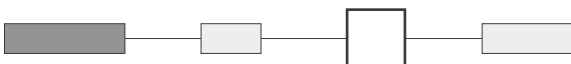

00 : Black (standard)

08 : Chrome plated (IS series only)

10 : White

IB & IS SERIES

SEALED MOMENTARY PUSHBUTTON SWITCHES

PLUNGER OPTION



104 : High plunger

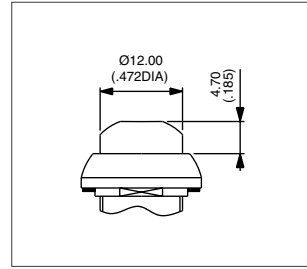

IB SERIES MOUNTING

Panel cut-out

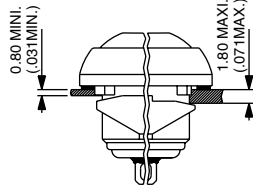
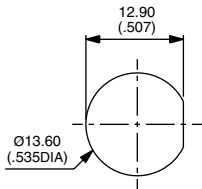

Matrix mounting

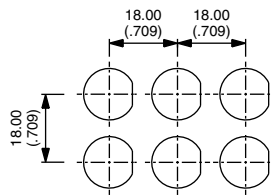

TACTILE FEEDBACK

Cross section

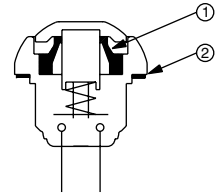

① Elastomer membrane ② Flat seal

Operating force/travel

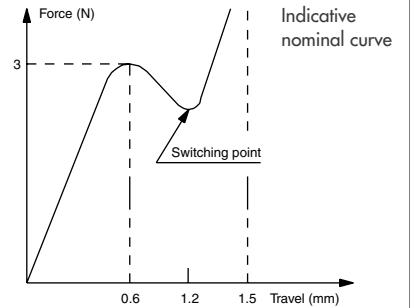

IS SERIES MOUNTING

Panel cut-out

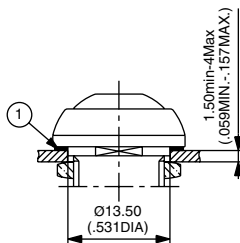
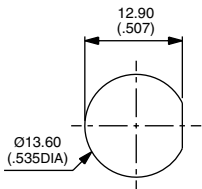

Matrix mounting

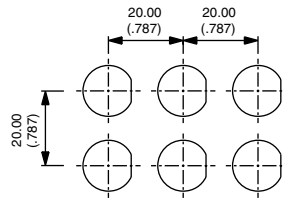

ADDITIONAL SEALING

By silicone boot, transparent (**U5125**) or black (**U5125-2**), for protection against frost and abrasion by sand. Order separately, see section N.

Operating temperature : -40°C to +125°C
Life expectancy : 500 000 cycles

Note : The switches remain sealed to IP 67 even after eventual perforation of the boot.

