

B1

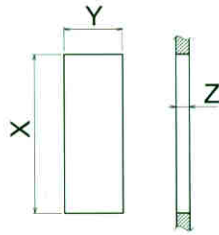

Z	Y	X
0.7-1.25	$11^{+0.2}_{-0}$	$30.0^{+0}_{-0.1}$
1.25-2	$11^{+0.2}_{-0}$	$30.2^{+0}_{-0.1}$
2-3	$11^{+0.2}_{-0}$	$30.6^{+0}_{-0.2}$
3-4	$11^{+0.2}_{-0}$	$30.8^{+0}_{-0.2}$



B **1** **?** **0** **0** **0**

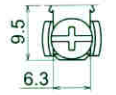
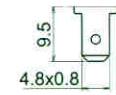
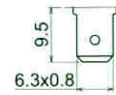
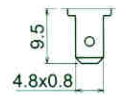
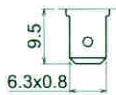
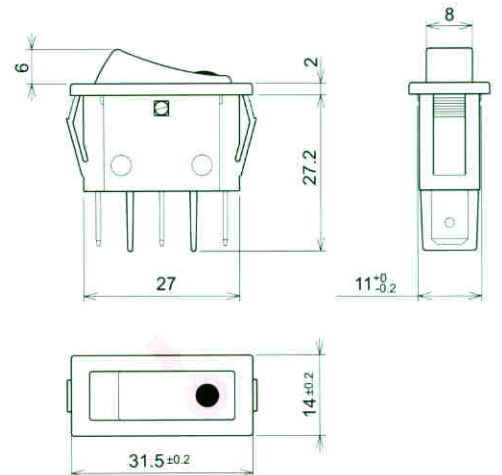
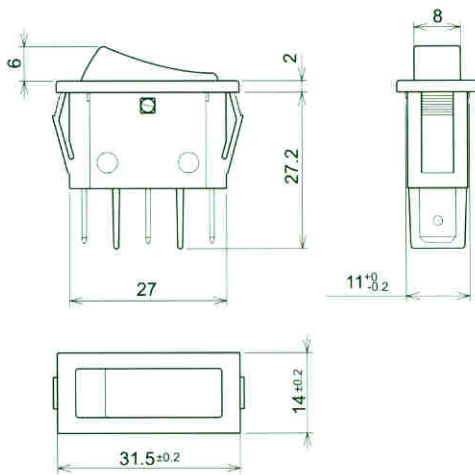

1

A

B

C

3

G

H

K

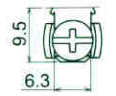
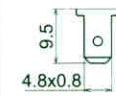
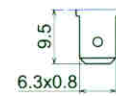
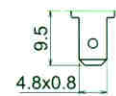
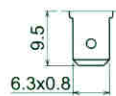
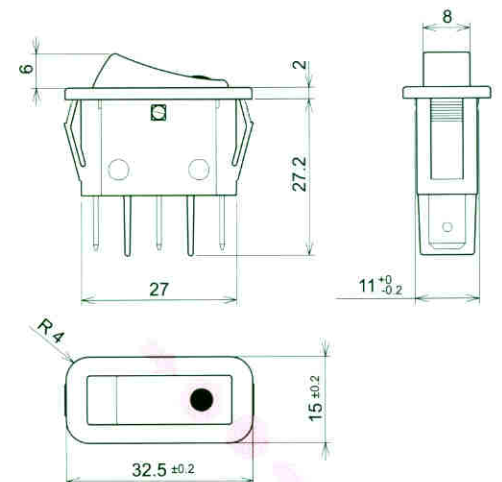
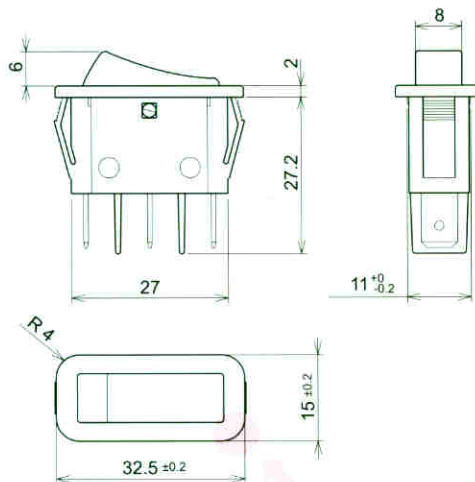

4

L

M

N

5

P

R

S

Interruttori a bilanciere
Rocker Switches

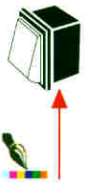

B	1				?					0	0	0
51	52	57	61	75	71	65	90	54	77			
1	2	3	4	5	6	8	9	A	Z			

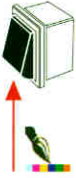

B	1					?				0	0	0
51	52	57	61	75	71	65	90	54	652	77		
1	2	3	4	5	6	8	9	A	B	Z		

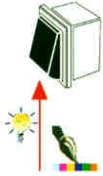

151	152	153	155	154	150							
G	H	E	L	K	F							

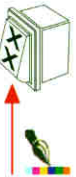

B	1						?			0	0	0
01	02	03	04	05	06	07	08	09	10	14		
1	2	3	4	5	6	7	8	9	A	B	0	X

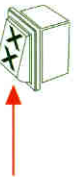

B	1							?		0	0	0
1	2	3	4	5	7	8	9	A	B	C	D	
E	F	H	J	K	L	N	P					0

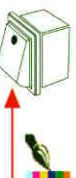

B	1								?	0	0	0
151	152	153	155	154	150							
G	H	E	L	K	F							
												0