

MS 高性能電動機起動器 Manual Motor Starters and Motor Starter Combinations

Up to 100 A

CNABB / Schact / 1 SAC / 0060 W0201 11-2001



- 經濟實用的方案 (最大額定功率 7.5 kW) – 無需熔斷器保護
Economic solution up to 7.5 kW – thanks to small fuseless protection
- 節省空間 – 含輔助觸頭，闊度僅需 45 mm
Saves space in installations – width: only 45 mm, even including an auxiliary contact
- 降低庫存成本 – 規格精簡，額定電流範圍高達 16 A
Saves inventory costs – small variety of types cover the range up to 16 A



MS 全系列電動機起動器 Manual Motor Starters Series MS

電動機起動器及其應用

Manual Motor Starters and Motor Starter Combinations

電機及其組成的電氣系統在現代工業生產和生活設施中佔有重要的地位。根據在生產過程的不同應用範圍，電機負載也會發生相應的變化。電動機起動器可有效地啟動和停止電動機。

ABB 電動機起動器能大大增強工廠的可靠和適用性，當極快的短路故障發生時，也不會損壞電動機。

ABB 電動機起動器組合為您的電動機保護提供一個可靠和具成本效益的方案。

Electric motors and the applications they provide are valuable assets in modern industrial facilities. They are exposed to strong load variations depending on the way they are incorporated into the production process.

Manual motor starters from ABB switch motors on and off properly and protect them in case of overload and short circuit.

The ABB manual motor starter know-how increases the reliability and availability of the

plant thanks to the extremely quick short circuit cut-off in cases that could cause motor damage. Therefore, ABB motor starter combinations provide for reliable, cost-efficient solutions for all your motor protection needs.

ABB 全系列的電動機起動器可對電機及配電線路進行以下全面可靠的保護：

- 過載保護
- 短路保護
- 斷相保護
- 欠壓保護
- 過熱保護

Manual motor starters provide for protection:

- Overload
- Short circuit
- Phase failure
- Undervoltage
- Overheating

無需熔斷器可節省成本和空間，ABB MS 電動機起動器在發生短路故障時在3毫秒內分斷，提供經濟、高效、可靠和便捷的電機保護方案。

Fuseless protection saves cost and space and provides for quick reaction under short circuit condition, switching the motor off within 3 ms. Easy to handle, cost effective solution.



ABB 全系列的電動機起動器廣泛用於以下行業：

- 機床
- 輕工機械（紡織、陶瓷）
- 傳輸系統
- 石油化工
- 製藥
- 環保（水處理、垃圾處理）
- 電站
- 樓宇自控

The manual motor starters from ABB can be used in:

- General engineering and plants
- Industries
- Conveyor systems
- Chemical industries including process engineering
- Pharmaceutical industries
- Automation of buildings, e. g. in air-conditioning
- Environmental plants
- Power stations
- Fresh water and sewage plants
- Machine tools

MS 全系列電動機起動器 Manual Motor Starters Series MS

ABB 的 MS 全系列電動機起動器的開關容量 Switching capability of the manual motor starters from ABB

ABB的MS全系列電動機起動器，額定電流由 0.1 至 100A。可對電機和線路進行高效可靠的短路，過載及斷相保護。

用戶可根據額定電流，額定短路極限分斷能力及其他要求選取相應系列產品。

ABB offers a wide range of manual motor starters providing highly efficient motor protection up to 100 A. The arc breaking capacity of the devices can reach up to 100 kA depending of the motor starter type used, without the necessity for any special upstream protection.

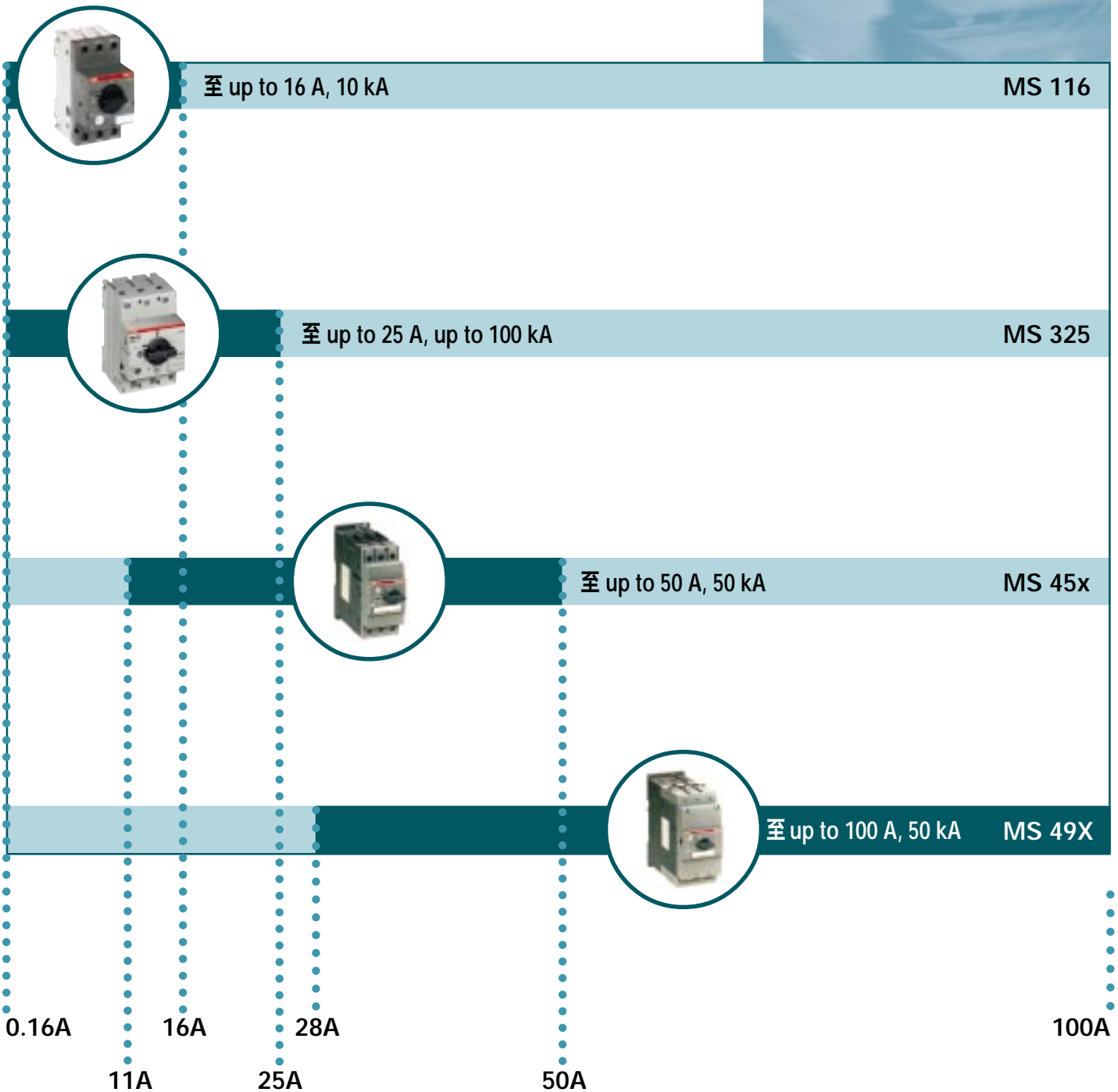

MS 全系列電動機起動器 Manual Motor Starters Series MS

電動機起動器組合

Motor Starter Combinations

MS系列電動機起動器可與ABB的A和EB系列接觸器，以及B系列微型接觸器完美配合，提供簡單可靠的電機啟動組合。

由MS 325，MS 450及MS 495組成的起動裝置可適用於不同場合，這些模塊式設計為用戶帶來更完善的服務和更快捷的操作反應。

The manual motor starters from ABB are designed to be easily coordinated with various other components from ABB to build a motor starter combination. These combinations include, e. g. the A-Series and EB Series contactors from ABB, as well as other contactors like an operating mechanism or mini-contactors Series "B".

Together with the manual motor starters MS 325, MS 450 and MS 495 these ABB components form coordinated starter combinations for a large variety of applications. Such a modular philosophy brings end users an improved service and faster reactions in operating systems.

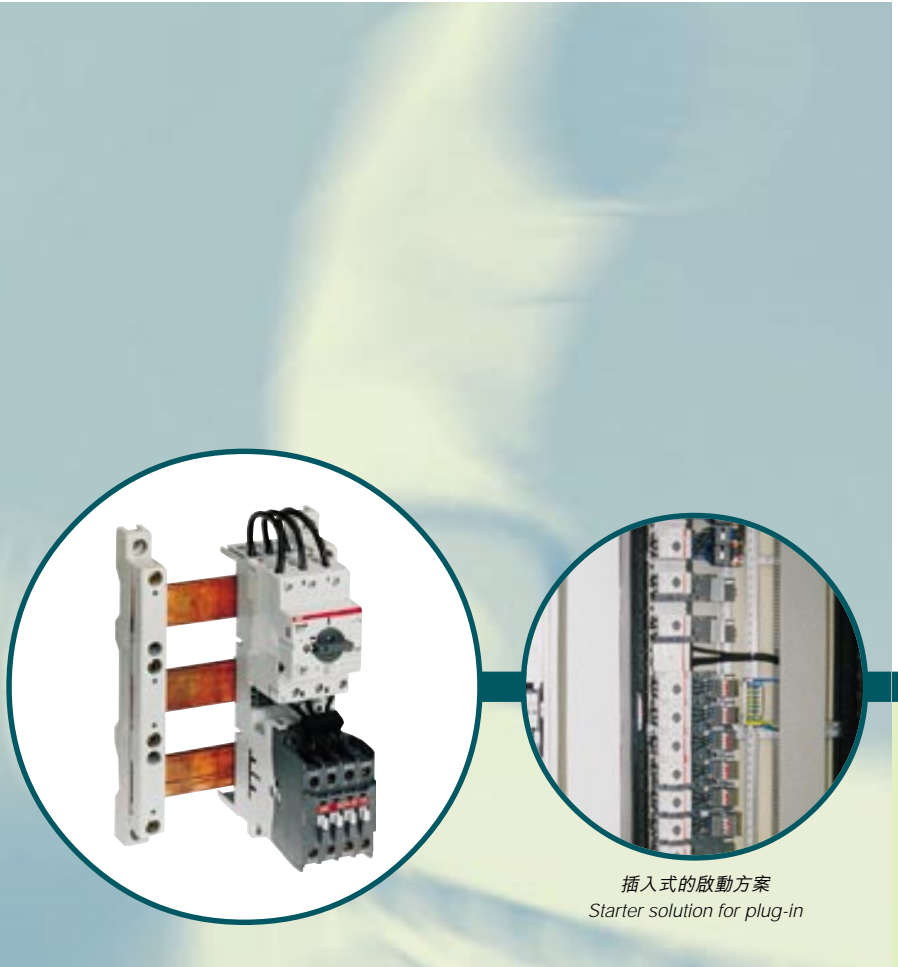

插入式的啟動方案
Starter solution for plug-in

直接啟動器 DLA

DOL Starters DLA

ABB DLA 直接啟動器是由MS 325與A系列接觸器安裝在同一底座上，MS 325可被夾起，成為自動連接的起動器組合。可在前面快捷安裝，輕巧的體積和耐用的設計是ABB DLA直接啟動器的優點。

DLA starters from ABB comprise of a mounting plate in which a contactor of ABB's "A"-series is already incorporated. A unit MS 325 can be clipped, forming an automatically connected motor starter combination. Fast front connection, compact dimensions and a robust design are only the most obvious advantages of ABB's DLA motor starters.

單獨接線方案

用戶可根據需要靈活接線和選購獨立的電動機起動器及接觸器

Separate gear concept

Individual devices for single wiring Manual motor starter and contactor can be wired according to customer demands



模塊化方案

MS325與A接觸器安裝在同一底座上

顧客利益

- 易於設計
- 減少接線
- 結構緊湊，節省空間
- 易於轉換
- 易於維護

Modular concept

Motor Starter Combinations Manual motor starter and contactor are mounted on a common plate

Customer benefits:

- fully coordinated modular assembly
- easy planing
- no wiring necessary
- compact – space saving
- easy to change
- better and quicker service

MS 全系列電動機起動器 Manual Motor Starters Series MS

技術數據 Technical Data

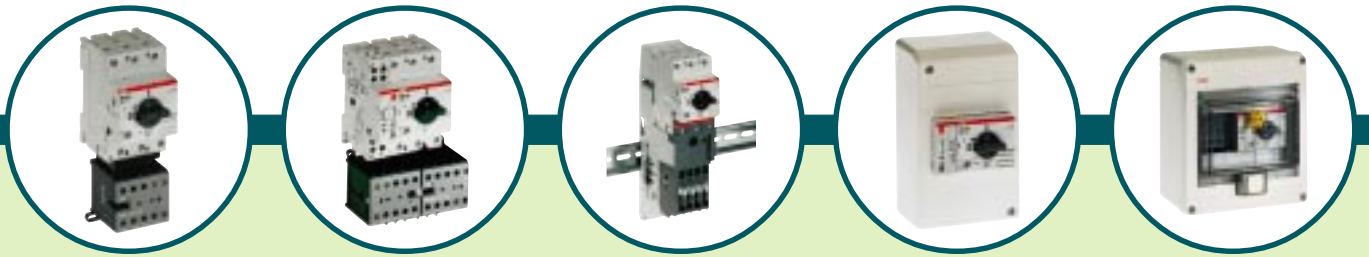

技術數據 Technical Data

型號	Type	MS116	MS325	MS450 / 451	MS495 / 496	MS497
標準	Standard	IEC 60 / EN 60 947-1, 947-2, 947-4-1, 947-5-1				
額定工作電壓	Rated Operating Voltage	690V AC / 440V DC			690V AC	
最大額定電流 (A)	Max. Rated Current	16	25	50	100	100
電流等級	Rated Current Range	0.1 - 16 (11)	0.1 - 25 (14)	11 - 50 (7)	28 - 100 (6)	11 - 100 (10)
脫扣等級	Tripping Class	10A	10A	10, 20	10, 20	10
工作頻率	Operating Frequency	50 / 60 Hz				
溫度補償	Temperature Compensation	有				
斷相保護	Phase Failure	有				
機械壽命	Mechanical Endurance	100,000	100,000	50,000		
允許環境溫度	Ambient Temperature	-25 ~ +55 °C			-20 ~ +60 °C	
允許海拔高度 (米)	Permissible Altitude (m)	3000			2000	

MS 系列電動機起動器 Manual Motor Starters Series MS

選配件組合 Combinations with accessories



MS 325 帶 B6 微型接觸器
MS 325 with mini contactor B6



MS325 帶輔助觸頭報警觸頭配微型可逆接觸器 VB 6
MS 325 + HK + SK with compact reversing contactor VB 6

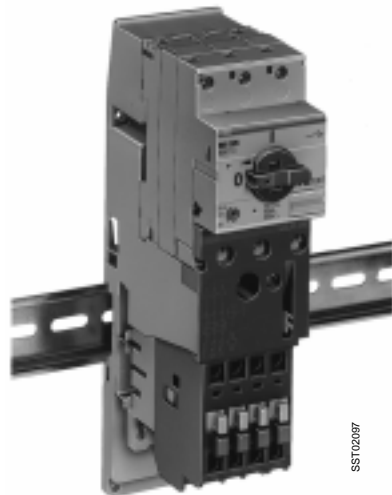

MS325 配 DLA 直接啟動單元
MS 325 with starter block DLA

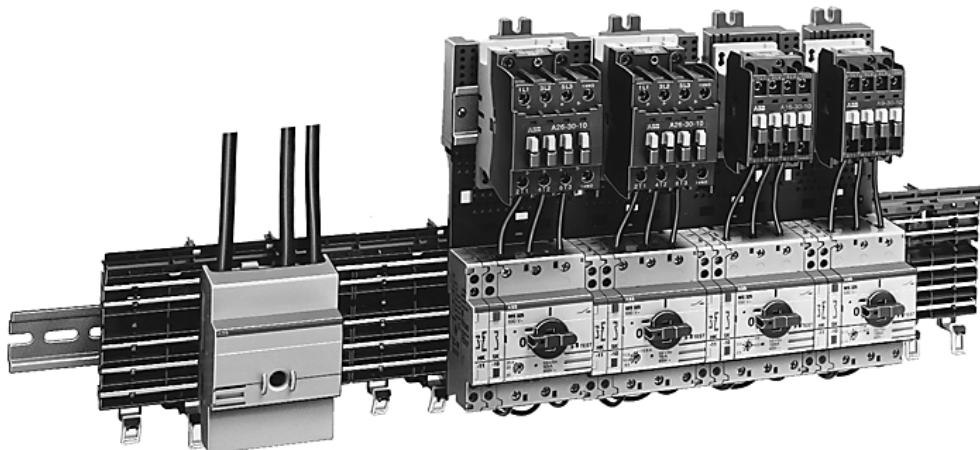

MS 325 與 A 接觸器接於 smissline 母排
MS 325 and A contactors on combined modules in the socket busbar system smissline-S

MS 系列電動機起動器 Manual Motor Starters Series MS

技術數據 Technical Data













MS 325 帶欠壓脫扣器
MS 325 with undervoltage release UA



MS 325 帶輔助並進線端子和母排
MS 325 with auxiliary switch HK cross-wired with phase buses and power infeed block

認證及證書 Approvals and certificates

產品類型 Unit type	認可機構 Approvals	認可標誌 Approv.marks	船用權威機構 Ships' classification								
測試標誌 Identification label	     	   									
認可機構縮寫 Initials Validity	SEV 瑞士 Switzerland	DEMKO 丹麥 Denmark	DNV 挪威 Norway	EL.Inspect. 芬蘭 Finland	CSA 加拿大 Canada	UL 美國 USA	EEExe PTB. KEMA	BV 法國 France	PTB 德國 Germany	GL 德國 Germany	LRS 英國 Great Britain
MS 116					■	■				□	□
MS 325	■	■	■	■	■	■		■	■	■	■
MS 450			■		■	■	■			■	
MS 495			■		■	■	■			■	
MS 497					■	■	■			□	

■ 普通型已獲準：在強制要求時可供所獲準的識別標籤。
Normal version approved: Identification labels bear the approval mark if it is mandatory.

□ 已提交待批准。歡迎垂詢交貨期。
Submitted for approval. Please enquire about delivery times.

其他證書和認可機構可另行提供。
Other certificates and approvals on request.

MS 116 系列電動機起動器

Manual Motor Starters Series MS 116

訂貨細則 Ordering Details

型號 Type	訂貨編號 Order Code	電流整定範圍 Setting Range	負載功率 Motorload
		AC3 380-400 V	kW

帶有熱敏和熱磁脫扣，短路保護高達10 kA
with thermal and electromagnetic trips short circuit protection up to 10 kA

MS116 - 0,16		0.1 ... 0.16	
MS116 - 0,25		0.16 ... 0.25	0.06
MS116 - 0,4		0.25 ... 0.4	0.1
MS116 - 0,63		0.4 ... 0.63	0.18
MS116 - 1,0		0.63... 1,0	0.25
MS116 - 1,6		1.0 ... 1.6	0.55
MS116 - 2,5		1.6 ... 2.5	1
MS116 - 4		2.5 ... 4.0	1.5
MS116 - 6,3		4.0 ... 6.3	2.2
MS116 - 10,0		6.3 ... 10.0	4
MS116 - 16,0		10 ... 16.0	7.5



附件 Accessories

前裝輔助觸頭 Auxiliary contact for front mounting

HKF1-11 1NO + 1NC

右面側裝輔助觸頭 (最多 2 個) Auxiliary contact for lateral attachment at right, max. 2 pieces

HK1-11 1NO + 1NC

HK1-20 2NO

HK1-02 2NC

右面側裝報警觸頭 Signal contact for lateral attachment at right, max. 2 pieces

SK1-11 1NO + 1NC

SK1-20 2NO

SK1-02 2NC

母線排 (適用於 2 台) Phase buses for cross wiring, for 2 devices

PS1-2-0 無輔助觸頭 without auxiliary contact

PS1-2-1 帶 1 個輔助觸頭 with 1 auxiliary contact

PS1-2-2 帶 2 個輔助觸頭 with 2 auxiliary contacts

母線排 (適用於 4 台) Phase buses for cross wiring, for 4 devices

PS1-4-0 無輔助觸頭 without auxiliary contact

PS1-4-1 帶 1 個輔助觸頭 with 1 auxiliary contact

PS1-4-2 帶 2 個輔助觸頭 with 2 auxiliary contacts

接線端子 Power infeed blocks, up to 63 A, 690 V

S1-M1 平 flat

S1-M2 高 high

MS 325 電動機起動器

Manual Motor Starters MS 325

訂貨細則 Ordering Details

選擇表

開放式設計、IP 20 外殼、抵抗氣候轉變、快速固定安裝路軌 DIN EN 50 022，35 mm 無輔助開關。

Selection

Open design, enclosure IP 20, resistant to changeable climates. Quick fastening on mounting rails DIN EN 50 022, 35 mm without auxiliary switch



MS 325



MS 325 帶輔助觸頭 HKF-11，前面安裝
MS 325 with auxiliary contacts HKF-11, front-mounted

型號 Type Design	電流整定範圍 Setting Range A . . . A	重量 Weight kg
-------------------	--------------------------------------	--------------------

MS 325 帶有熱敏和電磁脫扣，短路保護容量高達 100 kA 和 50 kA
MS 325 with thermal and electromagnetic trips, short-circuit-proof up to 100 kA, resp. 50 kA

MS325 – 0.16	0.1 – 0.16	0.347
MS325 – 0.25	0.16 – 0.25	0.347
MS325 – 0.4	0.25 – 0.4	0.347
MS325 – 0.63	0.4 – 0.63	0.347
MS325 – 1	0.63 – 1	0.347
MS325 – 1.6	1 – 1.6	0.347
MS325 – 2.5	1.6 – 2.5	0.347
MS325 – 4	2.5 – 4	0.347
MS325 – 6.3	4 – 6.3	0.347
MS325 – 9	6.3 – 9	0.347
MS325 – 12.5	9 – 12.5	0.347
MS325 – 16	12.5 – 16	0.347
MS325 – 20	16 – 20	0.347
MS325 – 25	20 – 25	0.347

MS 325 帶有熱敏和電磁脫扣，帶 1 常開 1 常閉輔助觸頭、前面安裝、短路保護容量高達 100 kA 和 50 kA
MS 325 with thermal and electromagnetic trips, with auxiliary switch 1 NO + 1 NC, front-mounted short-circuit-proof up to 100 kA, resp. 50 kA

MS325 – 0.16	0.1 – 0.16	0.347
MS325 – 0.25	0.16 – 0.25	0.347
MS325 – 0.4	0.25 – 0.4	0.347
MS325 – 0.63	0.4 – 0.63	0.347
MS325 – 1	0.63 – 1	0.347
MS325 – 1.6	1 – 1.6	0.347
MS325 – 2.5	1.6 – 2.5	0.347
MS325 – 4	2.5 – 4	0.347
MS325 – 6.3	4 – 6.3	0.347
MS325 – 9	6.3 – 9	0.347
MS325 – 12.5	9 – 12.5	0.347
MS325 – 16	12.5 – 16	0.347
MS325 – 20	16 – 20	0.347
MS325 – 25	20 – 25	0.347

MS 4xx 電動機起動器

Manual Motor Starters MS 4xx

訂貨細則 Ordering Details

選擇表

開放式設計、IP 20 外殼、抵抗氣候轉變、快速固定安裝路軌 DIN EN 50 022，35 mm 無輔助開關。

Selection

Open design, enclosure IP 20, resistant to changeable climates. Quick fastening on mounting rails DIN EN 50 022, 35 mm without auxiliary switch



MS 45x

SST02198



MS 450 帶輔助開關 HK4-11 已上鎖。
MS 450 with auxiliary switch HK4-11, locked

SST09298



MS 495 帶輔助開關 HKS4-02 分勵脫扣器 AA4 和端子護罩。
MS 495 with auxiliary switch HKS4-02 and open-circuit shunt release AA4 in addition to terminal shroud KA495C

SST 09498



MS 49x

SST01898

型號 Type Design	電流整定範圍 Setting Range A...A	重量 Weight kg
-------------------	----------------------------------	--------------------

MS 450 帶熱敏和電磁脫扣，脫扣等級 10，短路保護高達 50 kA MS 450 with thermal and electromagnetic trips, tripping class 10, short-circuit-proof up to 50 kA

MS450 - 16	11 - 16	0.96
MS450 - 20	14 - 20	0.96
MS450 - 25	18 - 25	0.96
MS450 - 32	22 - 32	0.96
MS450 - 40	28 - 40	0.96
MS450 - 45	36 - 45	0.96
MS450 - 50	40 - 50	0.96

MS 451 帶熱敏和電磁脫扣，脫扣等級 20，短路保護高達 50 kA MS 451 with thermal and electromagnetic trips, tripping class 20, short-circuit-proof up to 50 kA

MS451 - 16	11 - 16	0.96
MS451 - 20	14 - 20	0.96
MS451 - 25	18 - 25	0.96
MS451 - 32	22 - 32	0.96
MS451 - 40	28 - 40	0.96
MS451 - 45	36 - 45	0.96
MS451 - 50	40 - 50	0.96

MS 495 帶熱敏和電磁脫扣，脫扣等級 10，短路保護高達 50 kA MS 495 with thermal and electromagnetic trips, tripping class 10, short-circuit-proof up to 50 kA

MS495 - 40	28 - 40	2.1
MS495 - 50	36 - 50	2.1
MS495 - 63	45 - 63	2.1
MS495 - 75	57 - 75	2.1
MS495 - 90	70 - 90	2.1
MS495 - 100	80 - 100 ^①	2.1

MS 496 帶熱敏和電磁脫扣，脫扣等級 20，短路保護高達 100 kA MS 496 with thermal and electromagnetic trips, tripping class 20, short-circuit-proof up to 100 kA

MS496 - 40	28 - 40	2.1
MS496 - 50	36 - 50	2.1
MS496 - 63	45 - 63	2.1
MS496 - 75	57 - 75	2.1
MS496 - 90	70 - 90	2.1
MS496 - 100	80 - 100 ^①	2.1

MS 497 帶熱敏和電磁脫扣，脫扣等級 10，短路保護高達 100 kA MS 497 with thermal and electromagnetic trips, tripping class 10, short-circuit-proof up to 100 kA

MS497 - 16	11 - 16	2.1
MS497 - 20	14 - 20	2.1
MS497 - 25	18 - 25	2.1
MS497 - 32	22 - 32	2.1
MS497 - 40	28 - 40	2.1
MS497 - 50	36 - 50	2.1
MS497 - 63	45 - 63	2.1
MS497 - 75	57 - 75	2.1
MS497 - 90	70 - 90	2.1
MS497 - 100	80 - 100 ^①	2.1

① 最大電動機電流 95A
Max motor current 95A

MS 325 電動機起動器

Manual Motor Starters MS 325

選配件 Optional Accessories



RC 325 遙控機構
RC 325 Remote Control Device



開關櫃安裝件
Switch cubicle mounting kit



S3-M1

S3-M2



2 個 MS 325 的母線連接
Phase Rails
For 2 x MS 325



4 個 MS 325 的母線連接
Phase Rails
For 4 x MS 325

RC 325 遙控機構 (用於遙控操作) RC 325 Remote Control Device (For MS 325)

型號 Type	可選控制電壓 Operating Voltage	
RC 325	24V	AC / DC
	48V	AC / DC
	60V	AC / DC
	110V	AC / DC
	230V	AC/DC

開關櫃安裝件，軸長 32...180mm ROTARY HANDLE on compartment door kit, shaft length 32...180mm

設計
Design

OHB 1A H1 + OXS5X180 + ISAM 101923 R0001	不可鎖 unlookable
OHB 2A JM + OXS5X180 + ISAM 101923 R0001	可鎖 lookable
OHY 2A JM + OXS5X180 + ISAM 101923 R0001	可鎖 lookable

用於 MS 325 的連接端子 CONNECTION TERMINAL BLOCK for MS 325

型號 Type	說明 Description
S3-M1	25mm ²
S3-M2	用於母線 for phase rail

母線連接 660V, 63A Phase rails for cross-wiring 660V, 63A

設計
Design

PS3-2-0	2 個 MS 325，無輔助觸頭	2 MS 325, without aux. contact
PS3-3-0	3 個 MS 325，無輔助觸頭	3 MS 325, without aux. contact
PS3-4-0	4 個 MS 325，無輔助觸頭	4 MS 325, without aux. contact
PS3-5-0	5 個 MS 325，無輔助觸頭	5 MS 325, without aux. contact
PS3-2-1	2 個 MS 325，1 個輔助觸頭	2 MS 325, with 1 aux. contact
PS3-3-1	3 個 MS 325，1 個輔助觸頭	3 MS 325, with 1 aux. contact
PS3-4-1	4 個 MS 325，1 個輔助觸頭	4 MS 325, with 1 aux. contact
PS3-5-1	5 個 MS 325，1 個輔助觸頭	5 MS 325, with 1 aux. contact

MS 325 電動機起動器

Manual Motor Starters MS 325

選配件 Optional Accessories



UA



HK



SK



IP 65 外殼

可加欠電壓脫扣器 UA UNDERVOLTAGE TRIP UA to be inserted

型號 Type	額定電壓 Rated Voltage
UA-24	Uc 24V ~
UA-48	Uc 48V ~
UA-60	Uc 60V ~
UA-110	Uc 110V ~
UA-230	Uc 230V ~
UA-400	Uc 400V ~
UA-415	Uc 415V ~
UA-500	Uc 500V ~

可加裝的分勵脫扣器 AA Shunt trips AA, to be inserted

型號 Type	額定電壓 Rated Voltage
AA 60	24 ... 60 V AC / DC
AA 240	110 ... 240 V AC / DC

半模塊寬的卡裝輔助觸頭 HK (最多 2 個) AUXILIARY CONTACTS HK snap on 1/2 module (max. 2 pcs.)

型號 Type	觸頭 Contacts
HK-11	1 NO + 1 NC
HK-20	2 NO
HK-02	2 NC

半模塊寬的卡裝報警觸頭 SK (最多 1 個) Signal CONTACT SK snap on 1/2 module (max. 1 pc.)

型號 Type	觸頭 Contacts
SK-11	1 NO + 1 NC

塑料外殼，IP 65 帶有 N 和 PE 端子 MOULDED PLASTIC ENCLOSURE IP65 lockable with N and PE terminal

型號 Type	設計 Design	說明 Description
OTPA 325 B2P1	灰色外殼及蓋板 Enclosure and cover, grey	用於 MS 325 帶有 1HK, 1 SK 或 1 AS
OTPA 325 A2P1	黃色緊停 OFF 蓋板，紅色卡裝卡 Emergency OFF cover, yellow clamp lever red	用於 MS 325 帶有 1HK, 1 SK 或 1 AS

MS 4xx 電動機起動器

Manual Motor Starters MS 4xx

選配件 Optional Accessories

For MS 450, MS 451, MS 495, MS 496, MS 497



UA4-HK



AA4



HK4-11



HKS4-02

欠電壓脫扣器 UNDERVOLTAGE RELEASE

型號 Type	額定電壓 Rated Voltage	觸頭 Contacts
UA4	110 V AC	-
UA4	230 V AC	-
UA4	400 V AC	-
UA4-HK	230 V AC	2 NO
UA4-HK	400 V AC	2 NO

分勵脫扣器 SHUNT TRIP

型號 Type	額定電壓 Rated Voltage
AA4	20 ... 24 V AC
AA4	90 ... 110 V AC
AA4	210 ... 240 V AC
AA4	350 ... 415 V AC

輔助觸頭 AUXILIARY CONTACTS

型號 Type	觸頭 Contacts
HK4-11	1 NO + 1 NC
HK4-W	1 NO
HKS4-11	1 NO + 1 NC
HKS4-20	2 NO
HKS4-02	2 NC

信號觸頭 PILOT SWITCH

型號 Type	觸頭 Contacts
SK4-11	1 NO + 1 NC

隔離器 ISOLATING SWITCH

型號 Type
TB450

MS 系列電動機起動器

Manual Motor Starters Series MS

尺寸圖 Dimensions

尺寸 Dimensions (mm)

MS 116

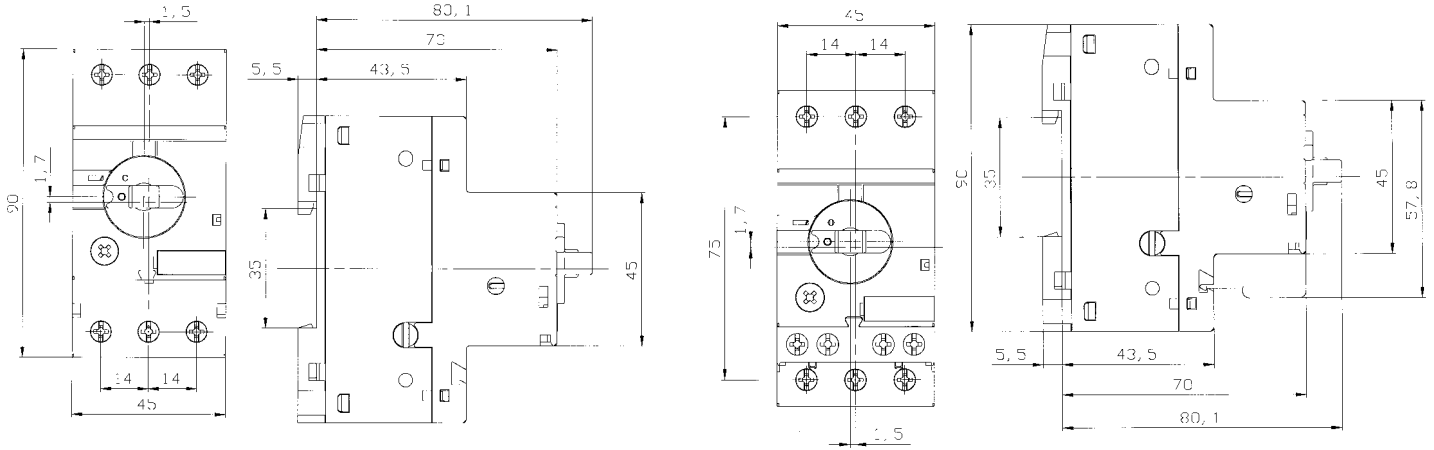

MS 325

報警觸頭 Signal contact SK
輔助觸頭 Auxiliary contact HK

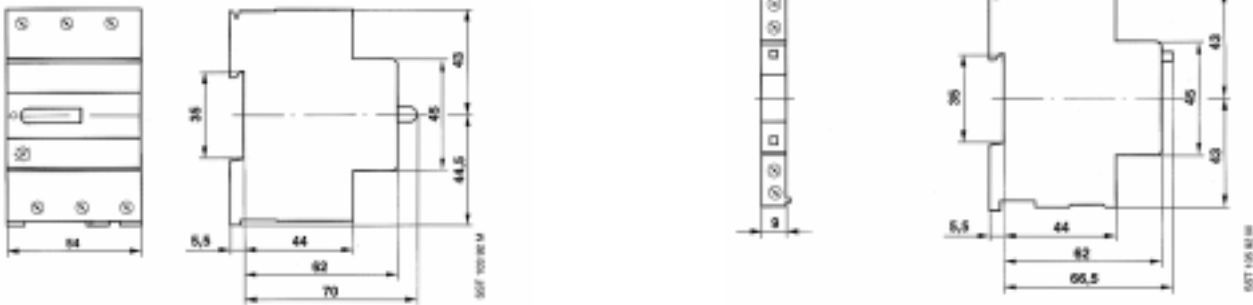

MS 45x

MS 45x 與隔離器
MS 45x with disconnector module TB 450

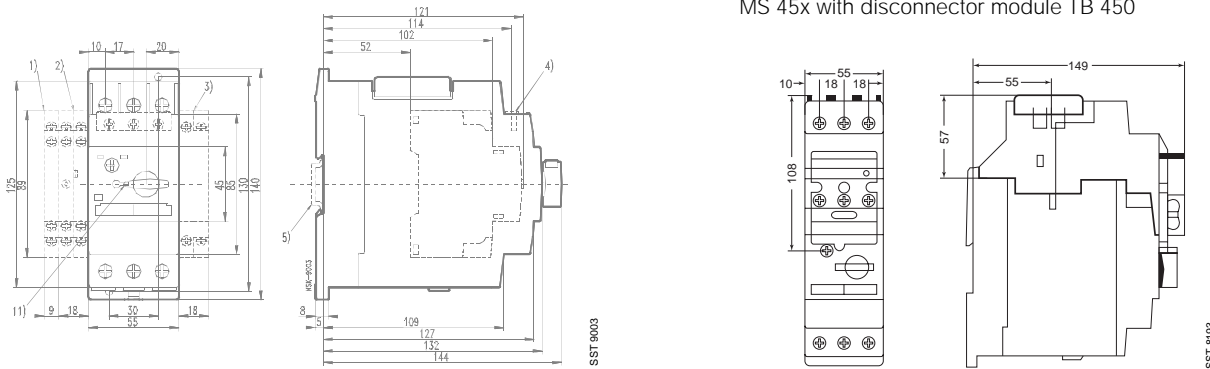

MS 49x

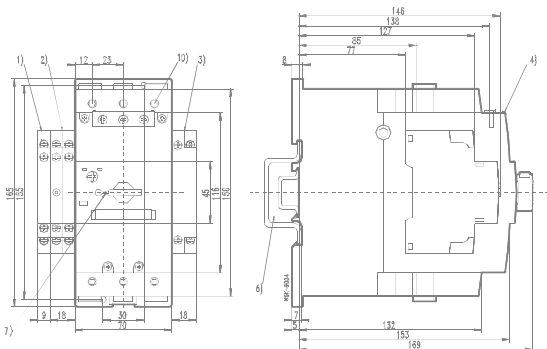

- 1) Auxiliary switch block HKS4
 - 2) Signal switch SK4
 - 3) Open-circuit shunt release/undervoltage release AA4, UA4, UA4-HK
 - 4) Auxiliary switch HK4
 - 5) Top-hat rail 35 mm to DIN EN 50022
 - 6) Top-hat rail 35 mm, 15 mm high to DIN EN 50022 or top-hat rail 75 mm to DIN EN 50023
 - 7) Twist knob lockable in zero position with bracket diameter 5 mm
- 1) 輔助觸頭 HKS4
 - 2) 報警觸頭 SK4
 - 3) 分勵脫扣器 AA4, UA4, UA4-HK
 - 4) 前裝輔助觸頭 HK4
 - 5) 35 毫米 DIN EN 50022 導軌槽
 - 6) 75 毫米 DIN EN 50023 導軌槽
 - 7) 斷開位置鎖扣 5 mm

MS 325 高性能電動機起動器 Power-Manual Motor Starters MS 325

線路圖和附件尺寸 Circuit Diagrams and Accessories Dimensions

線路圖 Circuit Diagrams

帶有按上述說明的附件的 MS 325
Manual motor starter MS 325 with accessories as shown in the above legend

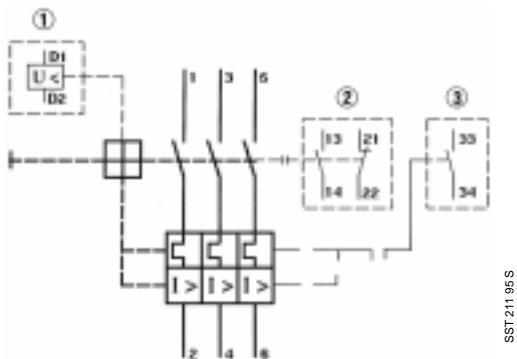

SST 211 96 S

說明 Legend

- ① 欠壓保護
Undervoltage trip block
- ② 輔助觸頭 1 NO + 1 NC 或 2 NO 或 2 NC
(對於 MS 325)
Auxiliary contact block 1 NO + 2 NC, also as 2 NO or 2 NC in the case of MS 325
- ③ 報警觸頭 (信號接點) 1 常開或 1 常閉
"Tripped" alarm switch block (signal contact) 1 NO or 1 NC

尺寸 Dimensions (mm)

開關櫃的安裝

Switch cabinet mounting set

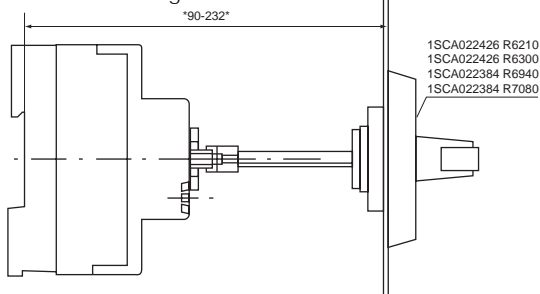

門上安裝

Door mounting set

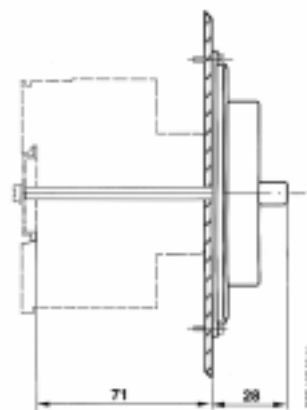

開關櫃的安裝開孔圖

Drilling Plan for switch cabinet mounting set

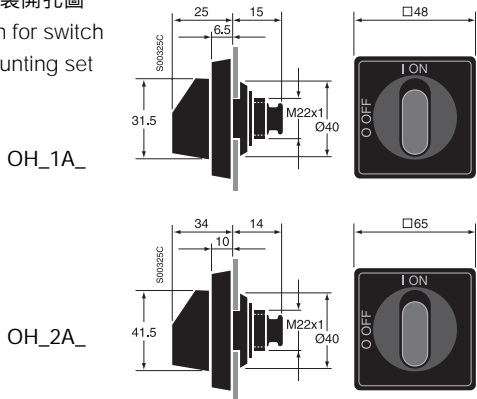

門上安裝開孔圖

Drilling plan for Door mounting set

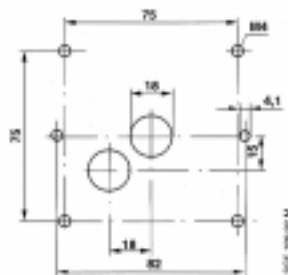
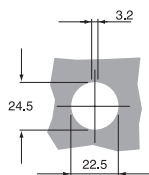

用於母線連接的端子

Connection terminal block for busbar

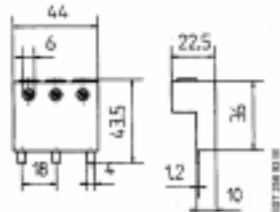

母線 (2 個 MS 325 和 1 個輔助接點)

Busbar connector for cross-wiring (2 x MS 325 with 1 auxiliary contact)

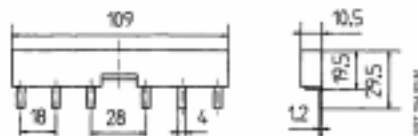

用於 25 mm² 導線連接的端子

Connection terminal block for 25 mm² wires

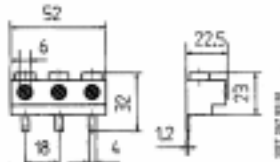

母線連接 (4 個 MS 325 和 1 個輔助接點)

Busbar connector for cross-wiring (4 x MS 325 with 1 aux. contact)

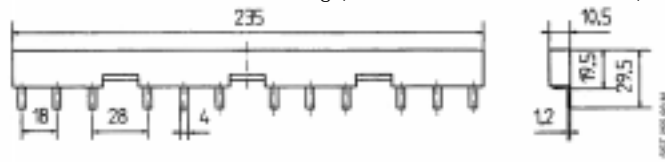

MS 系列電動機起動器和選配 Manual Motor Starters MS and Accessories

尺寸圖 Dimensions

尺寸 Dimensions (mm)

IP 65 塑料外殼
Moulded plastic enclosure IP 65

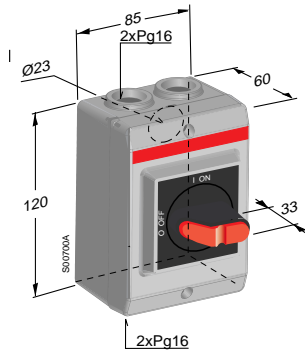

開孔圖
Drilling plan

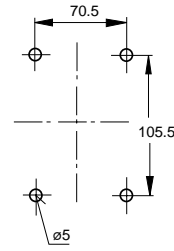

IP 40 塑料外殼
Moulded plastic enclosure IP 40



ABB (Hong Kong) Ltd.

低壓部：
香港新界大埔
大埔工業邨大喜街3號
電話：(852) 2929 3838
傳真：(852) 2929 3505

ABB Schalt- und Steuerungstechnik GmbH

P.O. Box 10 50 09
D-69040 Heidelberg
Telephone :+49 62 21 / 777-0
Telefax :+49 62 21 / 777-115
<http://www.abb.de/sst>

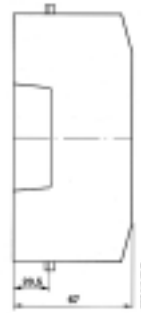
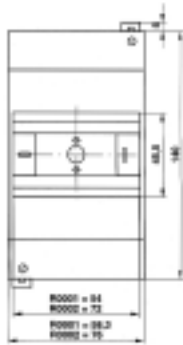
阿西亞·布朗·勃法瑞(中國)投資有限公司

北京總部：
中國北京市 100016
朝陽區酒仙橋路 10 號
恒通大廈
電話：(010) 8456 6688
傳真：(010) 8456 9907

天津辦事處：
中國天津市 300141
中山路 290 號
萬科中心辦公大樓 2505 室
電話：(022) 2621 6488
傳真：(022) 2621 6485

大連辦事處：
中國遼寧省大連市 116011
西崗區中山路 147 號
森茂大廈 12 樓
電話：(0411) 3696 021 / 3696 632
傳真：(0411) 3603 380

西安分公司：
中國陝西省西安市 710054
文藝路北口甲 1 號
鵬豪大廈 801-2 室
電話：(029) 7857 422 / 7861 766
傳真：(029) 7857 423

沈陽分公司：
中國遼寧省沈陽市 110001
和平區南京北街 206 號
沈陽假日大廈城市廣場二座 3-166 室
電話：(024) 2334 1818
傳真：(024) 2334 1306

長春辦事處：
中國吉林省長春市 130061
西安大路 16 號
國際大廈 A 座 7 層 709 室
電話：(0431) 8926 821 / 23 / 25
傳真：(0431) 8926 835

哈爾濱辦事處：
中國黑龍江省哈爾濱市 150001
紅軍街 26 號
北亞大廈 1001-2 室
電話：(0451) 3605 460 / 465-66
傳真：(0451) 3602 731

上海分公司：
中國上海市 200002
延安東路 100 號
聯誼大廈 7 樓
電話：(021) 6320 3333 / 6323 2032
傳真：(021) 6320 1132 / 6323 2697

武漢分公司：
中國湖北省武漢市 430079
武昌珞瑜路 200-1 號
東湖新技術開發區管理大樓 7 樓
電話：(027) 8740 7421 / 8749 1288
傳真：(027) 8740 7426

青島分公司：
中國山東省青島市 266071
香港中路 12 號
豐合廣場 B 區鑽石樓 310 室
電話：(0532) 5026 396 / 97 / 98
傳真：(0532) 5026 395

杭州辦事處：
中國浙江省杭州市 310009
慶春路 11 號
凱旋門商業中心 22 樓 A 座
電話：(0571) 8722 5333
傳真：(0571) 8722 5178

南京分公司：
中國江蘇省南京市 210002
中山東路 90 號
華泰大廈 18 樓
電話：(025) 6645 645
傳真：(025) 6645 338

濟南辦事處：
中國山東省濟南市 250011
泉城路 17 號
華能大廈 8 樓
電話：(0531) 6092 726
傳真：(0531) 6092 724

鄭州辦事處：
中國河南省鄭州市 450007
中原西路 220 號
裕達國際貿易中心 A 座 1806 室
電話：(0371) 7713 588
傳真：(0371) 7713 873

長沙辦事處：
中國湖南省長沙市 410005
黃興中路 88 號
平和堂商務樓 12B01
電話：(0731) 2562 898
傳真：(0731) 4445 519

成都分公司：
中國四川省成都市 610072
蜀都大道西端
濫柯華廣場 28 層 C, D, E 座
電話：(028) 7786 688
傳真：(028) 7744 101 / 7795 399

重慶分公司：
中國重慶市 400060
南坪北路 15 號
重慶楊子江假日飯店 2 樓
電話：(023) 6282 6688
傳真：(023) 6280 5369

昆明辦事處：
中國雲南省昆明市 650011
青年路 399 號
邦克飯店 6 樓 601 室
電話：(0871) 3158 188
傳真：(0871) 3158 186

福州分公司：
中國福建省福州市 350003
五四路 158 號
環球廣場 16 層 2 區
電話：(0591) 7844 824
傳真：(0591) 7814 889

南寧辦事處：
中國廣西省南寧市 530012
新民路 34-18 號
大明大廈 10 樓 D 座
電話：(0771) 2827 123
傳真：(0771) 2827 110

廣州分公司：
中國廣東省廣州市 510075
天河北路 183 號
大都會廣場 21 樓 1-8 及 16 室
電話：(020) 8755 0873
傳真：(020) 8755 0172

深圳辦事處：
中國深圳市 518033
福田區·福虹路
世貿廣場 A 座 23 樓 2302-2304 室
電話：(0755) 3679 990
傳真：(0755) 3676 437

<http://www.abb.com.cn>

CNABB / Schacht / 1 SAC / 0060 W0201 11-2001