

Ø22mm

YW Series Control Units



Innovative Design, Space-Saving, Safety, and Self-Cleaning Contacts

Emergency Stop Switches

Satisfy International Standards

- **Safety Lock Mechanism**

When the emergency stop signal has been generated during actuation of the emergency stop device, the emergency stop function shall be maintained until the emergency stop device is reset (disengaged) (IEC 60947-5-5, 6.2).

- **Direct Opening Action**

Even if the contacts are welded, NC contacts are forced to open and break the circuit (compliant to IEC 60947-5-1, Annex K, IEC 60947-5-5, 5.2).

- **Safe Pushbutton Design**

The pushbutton is designed to ensure that an object cannot become trapped between the mushroom button and the panel, disabling the button operation. In addition, the pushbutton is designed to prevent removal from the front of the panel (IEC 60947-5-5, 6.3.2).



Non-illuminated

Illuminated

Easy Operation

- **Push-to-lock, Pull/Turn-to-release**

YW emergency stop switches can be unlatched by either pulling or turning the operator.

Unlatching by pulling



Unlatching by turning



Unibody Pilot Lights

Higher Brightness

The new unibody pilot light achieves high brightness.

Short Depth behind the Panel

Unibody type measures only 42mm depth behind the panel.

Four Lens Shapes

Flush, flush with marking, extended, and dome.

Panel Mounting

Unibody pilot lights can be mounted on panels simply by tightening the locking ring.



Key Selector Switches



Plastic Bezel



Metal Bezel

A variety of operations, key removal positions, and circuits.

Wide range adds more options to choose from.

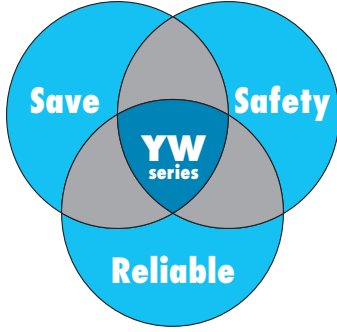

Safety

Integrated Finger-safe Terminal Cover
Degree of Protection: IP20
(From panel front: IP65)



Metal bezels are available for pushbuttons, illuminated pushbuttons, selector switches, and key selector switches.

Save

New Contact Block Design
YW series

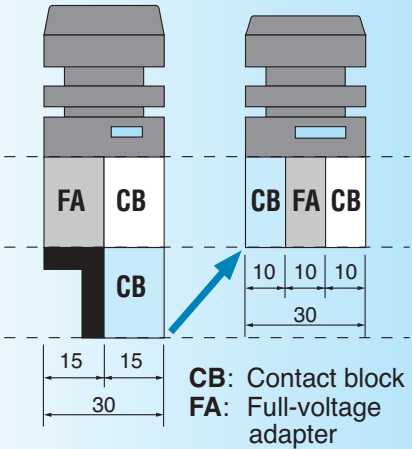

The new contact block design reduces the depth behind the panel.

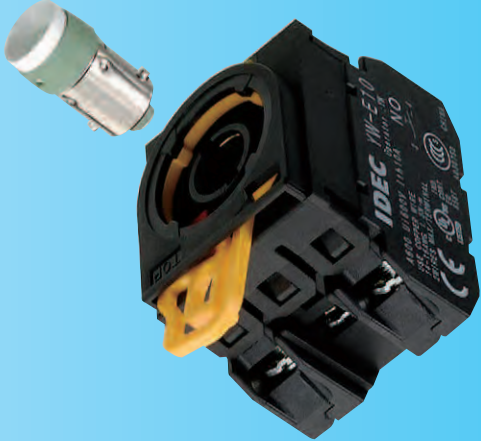

Reliable

Retained Locking Lever

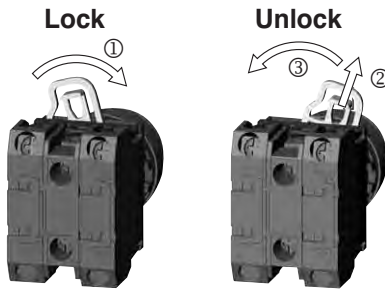

An innovative plastic locking lever is retained and eliminates the need for a separate lever lock.

Heavy-Duty Rugged Construction

Self-Cleaning Wiping-Action Contacts with Scored Contact Surfaces

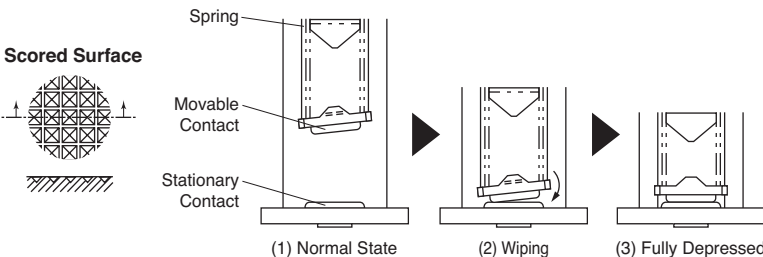

YW Series Control Units

Space-saving, 10-mm-thick contact blocks. Removable operator.

- Compact and light-weight
- IP20 finger-safe screw terminals (IEC 60529)
- Emergency stop switches feature safety lock mechanism, direct opening action, and safe pushbutton design.
- Metal bezel, unibody pilot lights, and key selector switches available.
- Separate contact block makes installation and removal easy. Pilot lights feature a large lens for a wide viewing angle.
- Matted surfaces on the buttons, lenses, and bezels reduce reflection of ambient light.
- UL, c-UL listed, EN compliant, and CCC approved.



- UL508, CSA C22.2 No. 14, EN 60947-1, EN 60947-5-1, EN 60947-5-5, GB 14048.5



Contact Ratings (Contact Block)

Rated Insulation Voltage		600V			
Rated Thermal Current		10A			
Operating Voltage		24V	120V	240V	380V
AC 50/60 Hz	Resistive Load (AC-12)	10A	10A	6A	2A
	Inductive Load (AC-15)	10A	6A	3A	1.9A
DC	Resistive Load (DC-12)	8A	2.2A	1.1A	—
	Inductive Load (DC-13)	4A	1.1A	0.55A	—

LED Lamp Ratings

Type No.	Rated Voltage	Rated Current	Color Code
LSED-6②	6V AC/DC	10 mA (A, R, Y) 7 mA (G, PW, S)	A: amber G: green PW: pure white R: red S: blue Y: yellow
LSED-1②	12V AC/DC	14 mA (A, R, Y) 13 mA (G, PW, S)	
LSED-2②	24V AC/DC	14 mA (A, R, Y) 13 mA (G, PW, S)	
LSED-H②	110V AC/DC	5.5 mA	
LSED-M3②	230/240V AC/DC	2.7 mA	

Note: Specify a color code in place of ② in the Type No.
Yellow LED lamps are used for white illumination of pilot lights and illuminated pushbuttons.

Incandescent Lamp Ratings

Type No.	Rated Voltage	Ratings
LS-T6	6V AC/DC	6.3V 1W
LS-T8	12V AC/DC	18V 1W
LS-T3	24V AC/DC	30V 1W

Unibody Pilot Light Ratings

Rated Voltage	Illumination Color	Rated Current
6V AC/DC	A, R, W, Y	16 mA
	G, PW, S	13 mA
12V AC/DC	A, G, PW, R, S, W, Y	20 mA
24V AC/DC		
100/110V AC		
230/240V AC		

Mounting Hole Layout

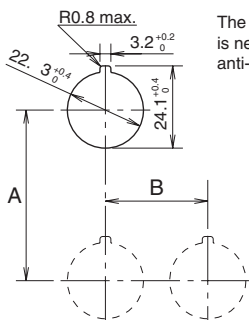

The 3.2-mm-wide key recess is necessary when the anti-rotation ring is used.

Unit	A (mm)	B (mm)
Emergency stop switch	50 min.	50 min.
Pushbutton Selector switch Key selector switch	50 min.	30 min.
Mushroom pushbutton	50 min.	40 min.
Pilot light (separate type)	30 min.*	30 min.
Pilot light (unibody type)	50 min.	30 min.

* Keep a minimum spacing of 50 mm when using a lamp of over 1W.

Specifications

Operating Conditions	Operating temperature:	-20 to +55°C (no freezing)
	Operating humidity:	45 to 85% RH (no condensation)
	Storage temperature:	-45 to +80°C
Degree of Protection	Storage humidity:	95% RH maximum
	From panel front:	IP65 (IEC 60529)
Insulation Resistance	Terminal:	IP20 (IEC 60529)
		100 MΩ
Dielectric Strength	Contact block:	2,500V, 1 minute
	Pilot light:	2,000V, 1 minute
Vibration Resistance	<Emergency stop switch>	
	Operating extremes / Damage limits:	
	10 to 500Hz, amplitude 0.35 mm, acceleration 50 m/s ² (5G)	
Shock Resistance	<Pushbutton, pilot light, illuminated pushbutton, selector switch, and key selector switch>	
	Operating extremes:	
	5 to 55 Hz, amplitude 0.5 mm	
Mechanical Life (minimum operations)	Damage limits:	
	30 Hz, amplitude 1.5 mm	
	<Emergency stop switch>	
Electrical Life (minimum operations)	Operating extremes:	
	150 m/s ² (15G)	
	Damage limits:	
Mechanical Life (minimum operations)	1,000 m/s ² (100G)	
	<Pushbutton, pilot light, illuminated pushbutton, selector switch, and key selector switch>	
	Operating extremes:	
Electrical Life (minimum operations)	100 m/s ² (10G)	
	Damage limits:	
	1,000 m/s ² (100G)	
Mechanical Life (minimum operations)	<Emergency stop switch>	
	250,000 (single contact block)	
	<Pushbutton and illuminated pushbutton>	
Electrical Life (minimum operations)	Momentary:	
	5,000,000 (single contact block)	
	1,000,000 (double contact block)	
Mechanical Life (minimum operations)	Maintained:	
	250,000 (single contact block)	
	100,000 (double contact block)	
Electrical Life (minimum operations)	<Selector switch and key selector switch>	
	250,000 (single contact block)	
	100,000 (double contact block)	
Mechanical Life (minimum operations)	<Emergency stop switch>	
	100,000 (single contact block)	
	<Pushbutton, selector switch, and key selector switch>	
Electrical Life (minimum operations)	100,000 (single contact block)	
	50,000 (double contact block)	

Emergency Stop Switches

Style	Operation	Contact	Type No.	Button Color Code
	Pushlock Pull/Turn Reset	1NC	YW1B-V4E01R	Red only
		2NC	YW1B-V4E02R	
		3NC	YW1B-V4E03R	
		1NO-1NC	YW1B-V4E11R	
		1NO-2NC	YW1B-V4E12R	
		2NO-1NC	YW1B-V4E21R	

Dimensions

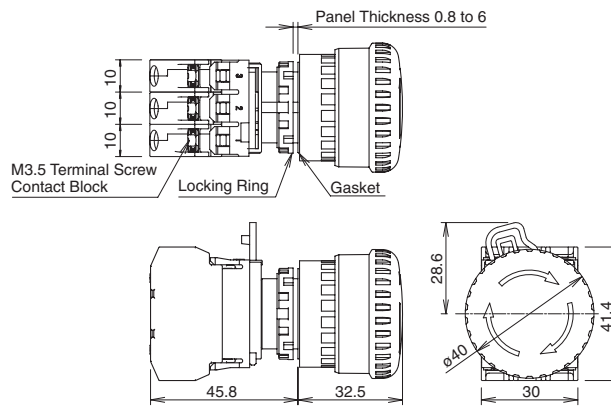

Note: The button is locked when pressed, and is reset when either pulled or turned clockwise.

Illuminated Emergency Stop Switches

Style	Illumination Type	Operation	Contacts	Type No.	③ Operating Voltage Code	Lens Color Code
	Without Lamp	Pushlock Pull/Turn Reset	1NC	YW1L-V4E01Q0R	0: without lamp 250V AC/DC max.	Red only
			2NC	YW1L-V4E02Q0R		
			1NO-1NC	YW1L-V4E11Q0R		
	LED		1NC	YW1L-V4E01Q③R	2: 6V AC/DC 3: 12V AC/DC 4: 24V AC/DC H: 110V AC/DC M3: 230/240V AC/DC	
			2NC	YW1L-V4E02Q③R		
			1NO-1NC	YW1L-V4E11Q③R		
	Incandescent		1NC	YW1L-V4E01Q③R	5: 6V AC/DC 6: 12V AC/DC 7: 24V AC/DC	
			2NC	YW1L-V4E02Q③R		
			1NO-1NC	YW1L-V4E11Q③R		

Note: Specify an operating voltage code in place of ③ in the Type No.

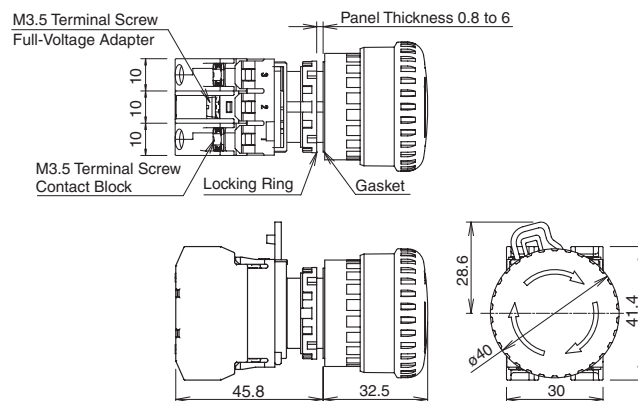

Dimensions



Note: The button is locked when pressed, and is reset when either pulled or turned clockwise.

All dimensions in mm.

Pushbuttons with Plastic Bezel

Style	Operation	Contact	Type No.	① Button Color Code	
Flush 	Momentary	1NO	YW1B-M1E10①	B: black G: green R: red S: blue W: white Y: yellow	
		1NC	YW1B-M1E01①		
		2NO	YW1B-M1E20①		
		2NC	YW1B-M1E02①		
		1NO-1NC	YW1B-M1E11①		
		3NO	YW1B-M1E30①		
		3NC	YW1B-M1E03①		
		2NO-1NC	YW1B-M1E21①		
	1NO-2NC	YW1B-M1E12①			
	Maintained	1NO	YW1B-A1E10①		
		1NC	YW1B-A1E01①		
		2NO	YW1B-A1E20①		
		2NC	YW1B-A1E02①		
		1NO-1NC	YW1B-A1E11①		
Extended 	Momentary	1NO	YW1B-M2E10①	B: black G: green R: red S: blue W: white Y: yellow	
		1NC	YW1B-M2E01①		
		2NO	YW1B-M2E20①		
		2NC	YW1B-M2E02①		
		1NO-1NC	YW1B-M2E11①		
	Maintained	1NO	YW1B-A2E10①		
		1NC	YW1B-A2E01①		
		2NO	YW1B-A2E20①		
		2NC	YW1B-A2E02①		
		1NO-1NC	YW1B-A2E11①		
Mushroom ø40mm 	Momentary	1NO	YW1B-M4E10①	B: black G: green R: red S: blue W: white Y: yellow	
		1NC	YW1B-M4E01①		
		2NO	YW1B-M4E20①		
		2NC	YW1B-M4E02①		
		1NO-1NC	YW1B-M4E11①		
	Maintained	1NO	YW1B-A4E10①		
		1NC	YW1B-A4E01①		
		2NO	YW1B-A4E20①		
		2NC	YW1B-A4E02①		
		1NO-1NC	YW1B-A4E11①		

Note: Specify a button color code in place of ① in the Type No.

Dimensions

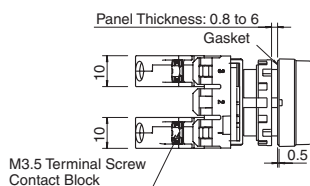

• **Flush**

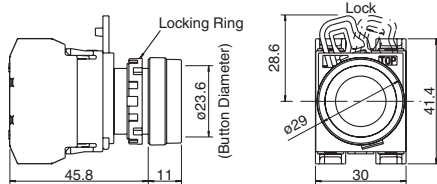

• **Mushroom**

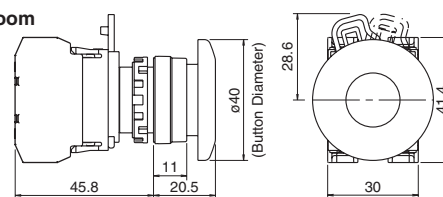

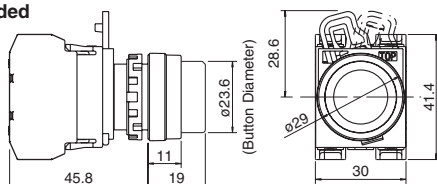

• **Extended**



All dimensions in mm.

Pushbuttons with Metal Bezel



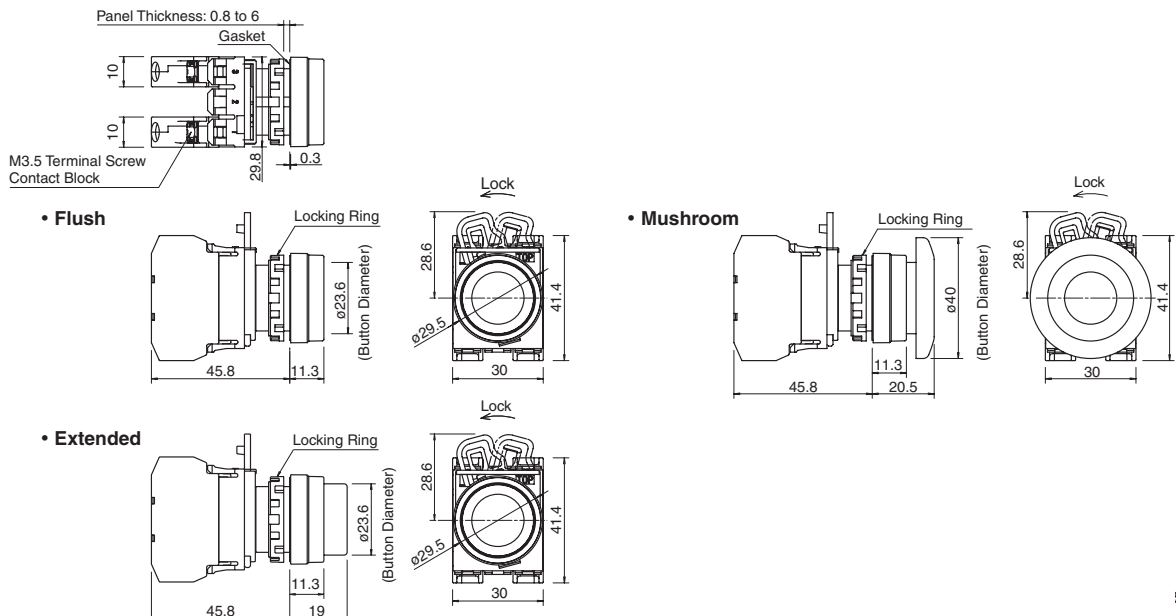

Style	Operation	Contact	Type No.	① Button Color Code	
Flush Metal Bezel 	Momentary	1NO	YW4B-M1E10①	B: black G: green R: red S: blue W: white Y: yellow	
		1NC	YW4B-M1E01①		
		2NO	YW4B-M1E20①		
		2NC	YW4B-M1E02①		
		1NO-1NC	YW4B-M1E11①		
		3NO	YW4B-M1E30①		
		3NC	YW4B-M1E03①		
		2NO-1NC	YW4B-M1E21①		
	Maintained	1NO	YW4B-A1E10①		
		1NC	YW4B-A1E01①		
		2NO	YW4B-A1E20①		
		2NC	YW4B-A1E02①		
		1NO-1NC	YW4B-A1E11①		
Extended Metal Bezel 	Momentary	1NO	YW4B-M2E10①	B: black G: green R: red S: blue W: white Y: yellow	
		1NC	YW4B-M2E01①		
		2NO	YW4B-M2E20①		
		2NC	YW4B-M2E02①		
		1NO-1NC	YW4B-M2E11①		
	Maintained	1NO	YW4B-A2E10①		
		1NC	YW4B-A2E01①		
		2NO	YW4B-A2E20①		
		2NC	YW4B-A2E02①		
		1NO-1NC	YW4B-A2E11①		
Mushroom ø40mm Metal Bezel 	Momentary	1NO	YW4B-M4E10①	B: black G: green R: red S: blue W: white Y: yellow	
		1NC	YW4B-M4E01①		
		2NO	YW4B-M4E20①		
		2NC	YW4B-M4E02①		
		1NO-1NC	YW4B-M4E11①		
	Maintained	1NO	YW4B-A4E10①		
		1NC	YW4B-A4E01①		
		2NO	YW4B-A4E20①		
		2NC	YW4B-A4E02①		
		1NO-1NC	YW4B-A4E11①		

Note: Specify a button color code in place of ① in the Type No.

Dimensions





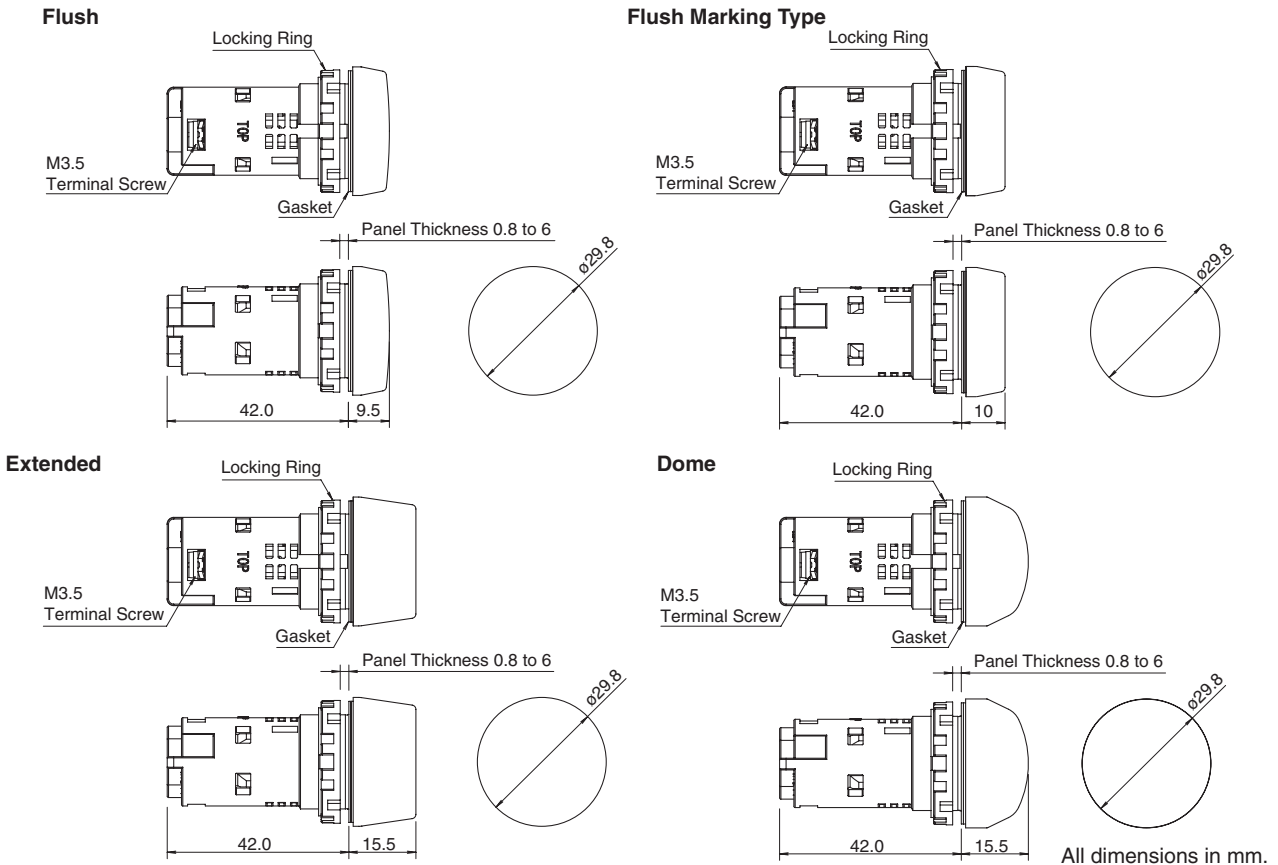

Pilot Lights (Unibody Type)

Style	Illumination Type	Operating Voltage	Type No.	② Lens Color Code
Flush Full Voltage 	LED	6V AC/DC	YW1P-1UQ2②	A: amber G: green PW: pure white R: red S: blue W: white Y: yellow
		12V AC/DC	YW1P-1UQ3②	
		24V AC/DC	YW1P-1UQ4②	
		100/110V AC	YW1P-1UQH②	
		230/240V AC	YW1P-1UQM3②	
Flush Marking Type Full Voltage 	LED	6V AC/DC	YW1P-1BUQ2②	
		12V AC/DC	YW1P-1BUQ3②	
		24V AC/DC	YW1P-1BUQ4②	
		100/110V AC	YW1P-1BUQH②	
		230/240V AC	YW1P-1BUQM3②	
Extended Full Voltage 	LED	6V AC/DC	YW1P-2TUQ2②	
		12V AC/DC	YW1P-2TUQ3②	
		24V AC/DC	YW1P-2TUQ4②	
		100/110V AC	YW1P-2TUQH②	
		230/240V AC	YW1P-2TUQM3②	
Dome Full Voltage 	LED	6V AC/DC	YW1P-2UQ2②	
		12V AC/DC	YW1P-2UQ3②	
		24V AC/DC	YW1P-2UQ4②	
		100/110V AC	YW1P-2UQH②	
		230/240V AC	YW1P-2UQM3②	

Dimensions







Pilot Lights (Separate Type)

Style	Illumination Type	Operating Voltage	Type No.	② Lens Color Code
Flush Full Voltage 	Without Lamp	250V AC/DC max.	YW1P-1EQ0②	A (amber), C (clear), G (green), R (red), S (blue), W (white), Y (yellow)
	LED	6V AC/DC	YW1P-1EQ2②	A (amber), G (green), PW (pure white), R (red), S (blue), W (white), Y (yellow) Built-in LED lamp: LSED-③②
		12V AC/DC	YW1P-1EQ3②	
		24V AC/DC	YW1P-1EQ4②	
		110V AC/DC	YW1P-1EQH②	
		230/240V AC/DC	YW1P-1EQM3②	
	Incandescent	6V AC/DC	YW1P-1EQ5②	A (amber), C (clear), G (green), R (red), S (blue), W (white), Y (yellow) Built-in incandescent lamp: LS-T③
		12V AC/DC	YW1P-1EQ6②	
		24V AC/DC	YW1P-1EQ7②	
	Flush Transformer Type 	LED	100/110V AC	YW1P-1EH2②
200/220V AC			YW1P-1EM2②	
115/120V AC			YW1P-1EH22②	
230/240V AC			YW1P-1EM42②	
Incandescent		100/110V AC	YW1P-1EH5②	A (amber), C (clear), G (green), R (red), S (blue), W (white), Y (yellow) Built-in incandescent lamp: LS-T6
		200/220V AC	YW1P-1EM5②	
		115/120V AC	YW1P-1EH25②	
		230/240V AC	YW1P-1EM45②	
Flush Marking Type Full Voltage 	Without Lamp	250V AC/DC max.	YW1P-1BEQ0②	A (amber), G (green), R (red), S (blue), W (white), Y (yellow)
	LED	6V AC/DC	YW1P-1BEQ2②	A (amber), G (green), PW (pure white), R (red), S (blue), W (white), Y (yellow) Built-in LED lamp: LSED-③②
		12V AC/DC	YW1P-1BEQ3②	
		24V AC/DC	YW1P-1BEQ4②	
		110V AC/DC	YW1P-1BEQH②	
		230/240V AC/DC	YW1P-1BEQM3②	
	Incandescent	6V AC/DC	YW1P-1BEQ5②	A (amber), G (green), R (red), S (blue), W (white), Y (yellow) Built-in incandescent lamp: LS-T③
		12V AC/DC	YW1P-1BEQ6②	
		24V AC/DC	YW1P-1BEQ7②	
	Flush Marking Type Transformer Type 	LED	100/110V AC	YW1P-1BEH2②
200/220V AC			YW1P-1BEM2②	
115/120V AC			YW1P-1BEH22②	
230/240V AC			YW1P-1BEM42②	
Incandescent		100/110V AC	YW1P-1BEH5②	A (amber), G (green), R (red), S (blue), W (white), Y (yellow) Built-in incandescent lamp: LS-T6
		200/220V AC	YW1P-1BEM5②	
		115/120V AC	YW1P-1BEH25②	
		230/240V AC	YW1P-1BEM45②	

Note: Specify a lens color code in place of ② in the Type No.
Clear lenses are used for PW (pure white) illumination of pilot lights.

ø22 YW Series Control Units

Style	Illumination Type	Operating Voltage	Type No.	② Lens Color Code	
Extended Full Voltage 	Without Lamp	250V AC/DC max.	YW1P-2TEQ0②	A (amber), C (clear), G (green), R (red), S (blue), W (white), Y (yellow)	
	LED	6V AC/DC	YW1P-2TEQ2②	A (amber), G (green), PW (pure white), R (red), S (blue), W (white), Y (yellow) Built-in LED lamp: LSED-③②	
		12V AC/DC	YW1P-2TEQ3②		
		24V AC/DC	YW1P-2TEQ4②		
		110V AC/DC	YW1P-2TEQH②		
		230/240V AC/DC	YW1P-2TEQM3②		
	Incandescent	6V AC/DC	YW1P-2TEQ5②	A (amber), C (clear), G (green), R (red), S (blue), W (white), Y (yellow) Built-in incandescent lamp: LS-T③	
		12V AC/DC	YW1P-2TEQ6②		
		24V AC/DC	YW1P-2TEQ7②		
	Extended Transformer Type 	LED	100/110V AC	YW1P-2TEH2②	A (amber), G (green), PW (pure white), R (red), S (blue), W (white), Y (yellow) Built-in LED lamp: LSED-6②
200/220V AC			YW1P-2TEM2②		
115/120V AC			YW1P-2TEH22②		
230/240V AC			YW1P-2TEM42②		
Incandescent		100/110V AC	YW1P-2TEH5②	A (amber), C (clear), G (green), R (red), S (blue), W (white), Y (yellow) Built-in incandescent lamp: LS-T6	
		200/220V AC	YW1P-2TEM5②		
		115/120V AC	YW1P-2TEH25②		
		230/240V AC	YW1P-2TEM45②		
Dome Full Voltage 		Without Lamp	250V AC/DC max.	YW1P-2EQ0②	A (amber), C (clear), G (green), R (red), S (blue), W (white), Y (yellow)
		LED	6V AC/DC	YW1P-2EQ2②	A (amber), G (green), PW (pure white), R (red), S (blue), W (white), Y (yellow) Built-in LED lamp: LSED-③②
	12V AC/DC		YW1P-2EQ3②		
	24V AC/DC		YW1P-2EQ4②		
	110V AC/DC		YW1P-2EQH②		
	230/240V AC/DC		YW1P-2EQM3②		
	Incandescent	6V AC/DC	YW1P-2EQ5②	A (amber), C (clear), G (green), R (red), S (blue), W (white), Y (yellow) Built-in incandescent lamp: LS-T③	
		12V AC/DC	YW1P-2EQ6②		
		24V AC/DC	YW1P-2EQ7②		
	Dome Transformer Type 	LED	100/110V AC	YW1P-2EH2②	A (amber), G (green), PW (pure white), R (red), S (blue), W (white), Y (yellow) Built-in LED lamp: LSED-6②
200/220V AC			YW1P-2EM2②		
115/120V AC			YW1P-2EH22②		
230/240V AC			YW1P-2EM42②		
Incandescent		100/110V AC	YW1P-2EH5②	A (amber), C (clear), G (green), R (red), S (blue), W (white), Y (yellow) Built-in incandescent lamp: LS-T6	
		200/220V AC	YW1P-2EM5②		
		115/120V AC	YW1P-2EH25②		
		230/240V AC	YW1P-2EM45②		

Note: Specify a lens color code in place of ② in the Type No.
Clear lenses are used for PW (pure white) illumination of pilot lights.

Dimensions (Separate Type Pilot Lights)

• **Flush**

Full Voltage

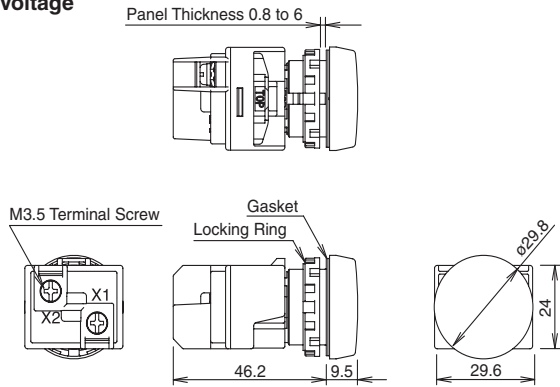

Transformer Type

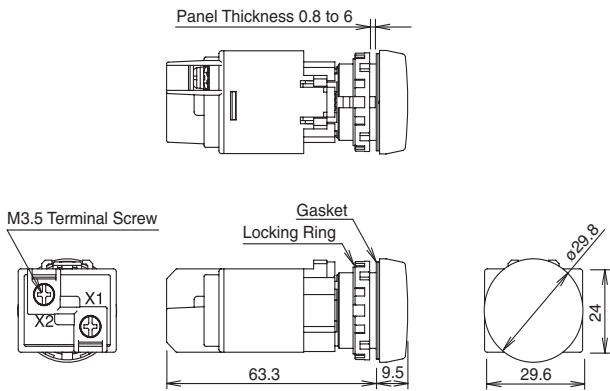

• **Flush Marking Type**

Full Voltage

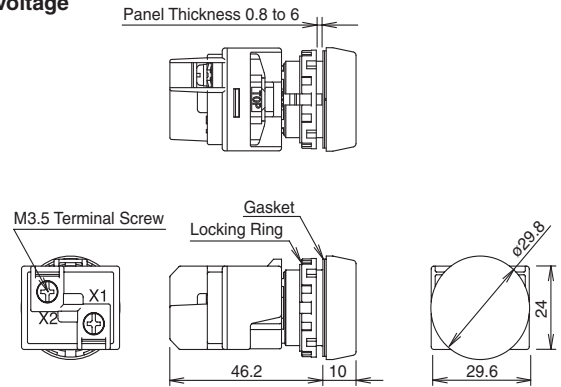

Transformer Type

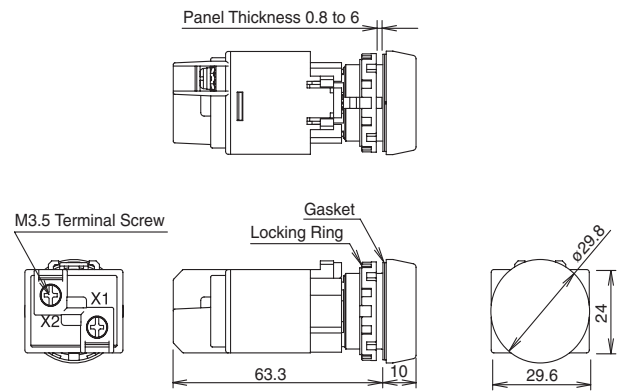

• **Extended**

Full Voltage

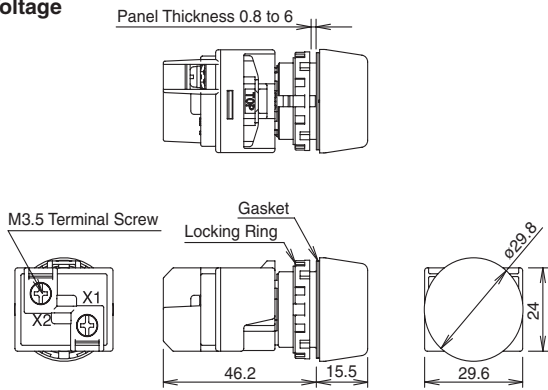

Transformer Type

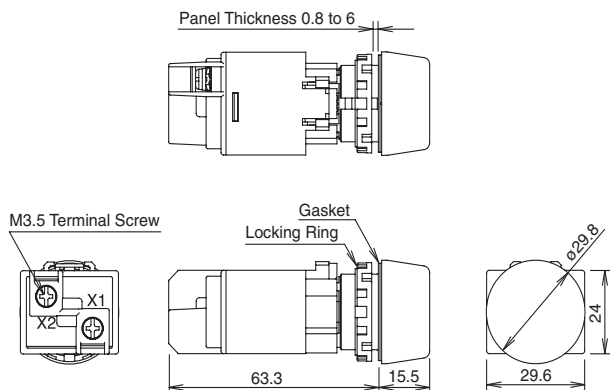

• **Dome**

Full Voltage

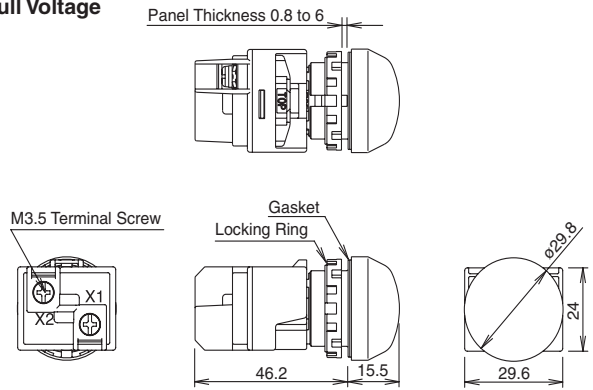

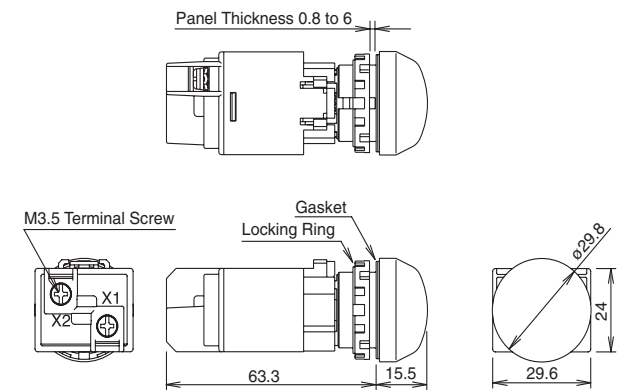

Transformer Type



All dimensions in mm.

Illuminated Pushbuttons with Plastic Bezel

Style	Illumination Type	Operation	Contacts	Type No.	③ Operating Voltage Code	② Lens Color Code				
	Without Lamp	Momentary	1NO	YW1L-M2E10Q0②	0: without lamp 250V AC/DC max.	A: amber G: green R: red S: blue W: white Y: yellow				
			1NC	YW1L-M2E01Q0②						
			2NO	YW1L-M2E20Q0②						
			2NC	YW1L-M2E02Q0②						
			1NO-1NC	YW1L-M2E11Q0②						
		Maintained	1NO	YW1L-A2E10Q0②						
			1NC	YW1L-A2E01Q0②						
			2NO	YW1L-A2E20Q0②						
			2NC	YW1L-A2E02Q0②						
			1NO-1NC	YW1L-A2E11Q0②						
			LED	Momentary			1NO	YW1L-M2E10Q③②	2: 6V AC/DC 3: 12V AC/DC 4: 24V AC/DC H: 110V AC/DC M3: 230/240V AC/DC	A: amber G: green PW: pure white R: red S: blue W: white Y: yellow Built-in LED lamp: LSED-③②
							1NC	YW1L-M2E01Q③②		
	2NO	YW1L-M2E20Q③②								
	2NC	YW1L-M2E02Q③②								
	Maintained	1NO		YW1L-A2E10Q③②						
		1NC		YW1L-A2E01Q③②						
		2NO	YW1L-A2E20Q③②							
	Incandescent	Momentary	1NO	YW1L-M2E10Q③②	5: 6V AC/DC 6: 12V AC/DC 7: 24V AC/DC	A: amber G: green R: red S: blue W: white Y: yellow Built-in incandescent lamp: LS-T③				
			1NC	YW1L-M2E01Q③②						
			2NO	YW1L-M2E20Q③②						
			2NC	YW1L-M2E02Q③②						
			1NO-1NC	YW1L-M2E11Q③②						
			Maintained	1NO			YW1L-A2E10Q③②			
		1NC		YW1L-A2E01Q③②						
2NO		YW1L-A2E20Q③②								
2NC		YW1L-A2E02Q③②								
1NO-1NC		YW1L-A2E11Q③②								
		Without Lamp		Momentary			1NO	YW1L-MF2E10Q0②	0: without lamp 250V AC/DC max.	A: amber G: green R: red S: blue W: white Y: yellow
			1NC				YW1L-MF2E01Q0②			
	2NO		YW1L-MF2E20Q0②							
	2NC		YW1L-MF2E02Q0②							
	1NO-1NC		YW1L-MF2E11Q0②							
	Maintained		1NO	YW1L-AF2E10Q0②						
			1NC	YW1L-AF2E01Q0②						
			2NO	YW1L-AF2E20Q0②						
			2NC	YW1L-AF2E02Q0②						
			1NO-1NC	YW1L-AF2E11Q0②						
			LED	Momentary	1NO	YW1L-MF2E10Q③②	2: 6V AC/DC 3: 12V AC/DC 4: 24V AC/DC H: 110V AC/DC M3: 230/240V AC/DC	A: amber G: green PW: pure white R: red S: blue W: white Y: yellow Built-in LED lamp: LSED-③②		
					1NC	YW1L-MF2E01Q③②				
	2NO	YW1L-MF2E20Q③②								
	2NC	YW1L-MF2E02Q③②								
	Maintained	1NO		YW1L-AF2E10Q③②						
		1NC		YW1L-AF2E01Q③②						
		2NO	YW1L-AF2E20Q③②							
	Incandescent	Momentary	1NO	YW1L-MF2E10Q③②	5: 6V AC/DC 6: 12V AC/DC 7: 24V AC/DC	A: amber G: green R: red S: blue W: white Y: yellow Built-in incandescent lamp: LS-T③				
			1NC	YW1L-MF2E01Q③②						
			2NO	YW1L-MF2E20Q③②						
			2NC	YW1L-MF2E02Q③②						
			1NO-1NC	YW1L-MF2E11Q③②						
			Maintained	1NO			YW1L-AF2E10Q③②			
		1NC		YW1L-AF2E01Q③②						
2NO		YW1L-AF2E20Q③②								
2NC		YW1L-AF2E02Q③②								
1NO-1NC		YW1L-AF2E11Q③②								

Note: Specify a lens color code in place of ② in the Type No.
Specify an operating voltage code in place of ③ in the Type No.

Style	Illumination Type	Operation	Contacts	Type No.	③ Operating Voltage Code	② Lens Color Code			
	Without Lamp	Momentary	1NO	YW1L-M4E10Q0②	0: without lamp 250V AC/DC max.	A: amber G: green R: red S: blue W: white Y: yellow			
			1NC	YW1L-M4E01Q0②					
			2NO	YW1L-M4E20Q0②					
			2NC	YW1L-M4E02Q0②					
		Maintained	1NO-1NC	YW1L-M4E11Q0②					
			1NO	YW1L-A4E10Q0②					
			1NC	YW1L-A4E01Q0②					
			2NO	YW1L-A4E20Q0②					
		LED	Momentary	2NC			YW1L-M4E02Q3②	2: 6V AC/DC 3: 12V AC/DC 4: 24V AC/DC H: 110V AC/DC M3: 230/240V AC/DC	A: amber G: green PW: pure white R: red S: blue W: white Y: yellow Built-in LED lamp: LSED-③②
				1NO-1NC			YW1L-M4E11Q3②		
				1NO			YW1L-A4E10Q3②		
				1NC			YW1L-A4E01Q3②		
	Maintained		2NO	YW1L-A4E20Q3②					
			2NC	YW1L-A4E02Q3②					
			1NO-1NC	YW1L-A4E11Q3②					
			1NO	YW1L-M4E10Q3②					
	Incandescent		Momentary	1NC	YW1L-M4E01Q3②	5: 6V AC/DC 6: 12V AC/DC 7: 24V AC/DC	A: amber G: green R: red S: blue W: white Y: yellow Built-in incandescent lamp: LS-T③		
				2NO	YW1L-M4E20Q3②				
				2NC	YW1L-M4E02Q3②				
				1NO-1NC	YW1L-M4E11Q3②				
		Maintained	1NO	YW1L-A4E10Q3②					
			1NC	YW1L-A4E01Q3②					
			2NO	YW1L-A4E20Q3②					
			2NC	YW1L-A4E02Q3②					
1NO-1NC		YW1L-A4E11Q3②							

Note: Specify a lens color code in place of ② in the Type No.
Specify an operating voltage code in place of ③ in the Type No.

Dimensions (Illuminated Pushbuttons with Plastic Bezel)

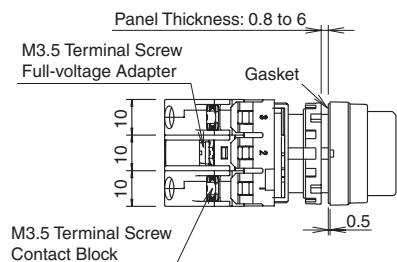

• Extended

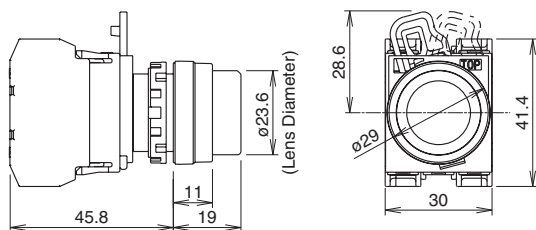

• Extended with Full Shroud

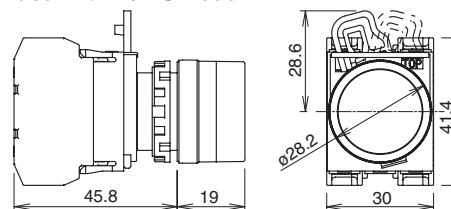

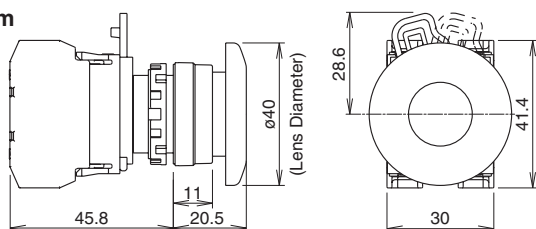

• Mushroom



All dimensions in mm.

Illuminated Pushbuttons with Metal Bezel

Style	Illumination Type	Operation	Contacts	Type No.	③ Operating Voltage Code	② Lens Color Code			
Extended 	Without Lamp	Momentary	1NO	YW4L-M2E10Q0②	0: without lamp 250V AC/DC max.	A: amber G: green R: red S: blue W: white Y: yellow			
			1NC	YW4L-M2E01Q0②					
			2NO	YW4L-M2E20Q0②					
			2NC	YW4L-M2E02Q0②					
		1NO-1NC	YW4L-M2E11Q0②						
		Maintained	1NO	YW4L-A2E10Q0②					
			1NC	YW4L-A2E01Q0②					
			2NO	YW4L-A2E20Q0②					
			2NC	YW4L-A2E02Q0②					
		1NO-1NC	YW4L-A2E11Q0②						
		LED	Momentary	1NO			YW4L-M2E10Q③②	2: 6V AC/DC 3: 12V AC/DC 4: 24V AC/DC H: 110V AC/DC M3: 230/240V AC/DC	A: amber G: green PW: pure white R: red S: blue W: white Y: yellow Built-in LED lamp: LSED-③②
				1NC			YW4L-M2E01Q③②		
	2NO			YW4L-M2E20Q③②					
	2NC			YW4L-M2E02Q③②					
	1NO-1NC		YW4L-M2E11Q③②						
	Maintained		1NO	YW4L-A2E10Q③②					
			1NC	YW4L-A2E01Q③②					
			2NO	YW4L-A2E20Q③②					
			2NC	YW4L-A2E02Q③②					
	1NO-1NC		YW4L-A2E11Q③②						
	Incandescent		Momentary	1NO	YW4L-M2E10Q③②	5: 6V AC/DC 6: 12V AC/DC 7: 24V AC/DC	A: amber G: green R: red S: blue W: white Y: yellow Built-in incandescent lamp: LS-T③		
				1NC	YW4L-M2E01Q③②				
		2NO		YW4L-M2E20Q③②					
		2NC		YW4L-M2E02Q③②					
1NO-1NC		YW4L-M2E11Q③②							
Maintained		1NO	YW4L-A2E10Q③②						
		1NC	YW4L-A2E01Q③②						
		2NO	YW4L-A2E20Q③②						
		2NC	YW4L-A2E02Q③②						
1NO-1NC		YW4L-A2E11Q③②							
Extended with Full Shroud 		Without Lamp	Momentary	1NO	YW4L-MF2E10Q0②			0: without lamp 250V AC/DC max.	A: amber G: green R: red S: blue W: white Y: yellow
				1NC	YW4L-MF2E01Q0②				
	2NO			YW4L-MF2E20Q0②					
	2NC			YW4L-MF2E02Q0②					
	1NO-1NC		YW4L-MF2E11Q0②						
	Maintained		1NO	YW4L-AF2E10Q0②					
			1NC	YW4L-AF2E01Q0②					
			2NO	YW4L-AF2E20Q0②					
			2NC	YW4L-AF2E02Q0②					
	1NO-1NC		YW4L-AF2E11Q0②						
	LED		Momentary	1NO	YW4L-MF2E10Q③②	2: 6V AC/DC 3: 12V AC/DC 4: 24V AC/DC H: 110V AC/DC M3: 230/240V AC/DC	A: amber G: green PW: pure white R: red S: blue W: white Y: yellow Built-in LED lamp: LSED-③②		
				1NC	YW4L-MF2E01Q③②				
		2NO		YW4L-MF2E20Q③②					
		2NC		YW4L-MF2E02Q③②					
		1NO-1NC	YW4L-MF2E11Q③②						
		Maintained	1NO	YW4L-AF2E10Q③②					
			1NC	YW4L-AF2E01Q③②					
			2NO	YW4L-AF2E20Q③②					
			2NC	YW4L-AF2E02Q③②					
		1NO-1NC	YW4L-AF2E11Q③②						
		Incandescent	Momentary	1NO	YW4L-MF2E10Q③②			5: 6V AC/DC 6: 12V AC/DC 7: 24V AC/DC	A: amber G: green R: red S: blue W: white Y: yellow Built-in incandescent lamp: LS-T③
				1NC	YW4L-MF2E01Q③②				
	2NO			YW4L-MF2E20Q③②					
	2NC			YW4L-MF2E02Q③②					
1NO-1NC	YW4L-MF2E11Q③②								
Maintained	1NO		YW4L-AF2E10Q③②						
	1NC		YW4L-AF2E01Q③②						
	2NO		YW4L-AF2E20Q③②						
	2NC		YW4L-AF2E02Q③②						
1NO-1NC	YW4L-AF2E11Q③②								

Note: Specify a lens color code in place of ② in the Type No.
Specify an operating voltage code in place of ③ in the Type No.

Style	Illumination Type	Operation	Contacts	Type No.	③ Operating Voltage Code	② Lens Color Code			
	Without Lamp	Momentary	1NO	YW4L-M4E10Q0②	0: without lamp 250V AC/DC max.	A: amber G: green R: red S: blue W: white Y: yellow			
			1NC	YW4L-M4E01Q0②					
			2NO	YW4L-M4E20Q0②					
			2NC	YW4L-M4E02Q0②					
		Maintained	1NO-1NC	YW4L-M4E11Q0②					
			1NO	YW4L-A4E10Q0②					
			1NC	YW4L-A4E01Q0②					
			2NO	YW4L-A4E20Q0②					
		LED	Momentary	1NO			YW4L-M4E10Q③②	2: 6V AC/DC 3: 12V AC/DC 4: 24V AC/DC H: 110V AC/DC M3: 230/240V AC/DC	A: amber G: green PW: pure white R: red S: blue W: white Y: yellow Built-in LED lamp: LSED-③②
				1NC			YW4L-M4E01Q③②		
				2NO			YW4L-M4E20Q③②		
				2NC			YW4L-M4E02Q③②		
	Maintained		1NO-1NC	YW4L-M4E11Q③②					
			1NO	YW4L-A4E10Q③②					
			1NC	YW4L-A4E01Q③②					
			2NO	YW4L-A4E20Q③②					
	Incandescent		Momentary	1NO	YW4L-M4E10Q③②	5: 6V AC/DC 6: 12V AC/DC 7: 24V AC/DC	A: amber G: green R: red S: blue W: white Y: yellow Built-in incandescent lamp: LS-T③		
				1NC	YW4L-M4E01Q③②				
				2NO	YW4L-M4E20Q③②				
				2NC	YW4L-M4E02Q③②				
		Maintained	1NO-1NC	YW4L-M4E11Q③②					
			1NO	YW4L-A4E10Q③②					
			1NC	YW4L-A4E01Q③②					
			2NO	YW4L-A4E20Q③②					
				2NC	YW4L-A4E02Q③②				
				1NO-1NC	YW4L-A4E11Q③②				

Note: Specify a lens color code in place of ② in the Type No.
Specify an operating voltage code in place of ③ in the Type No.

Dimensions (Illuminated Pushbutton with Metal Bezel)

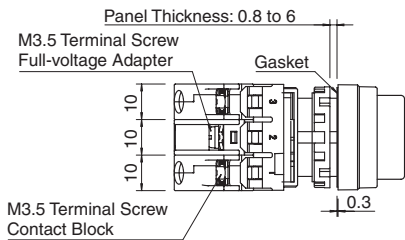

• **Extended**

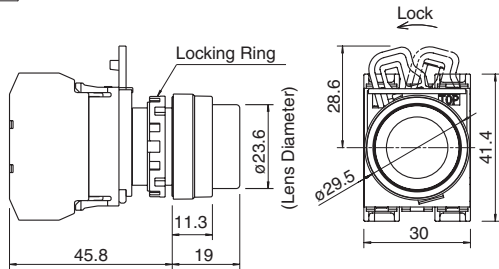

• **Extended with Full Shroud**

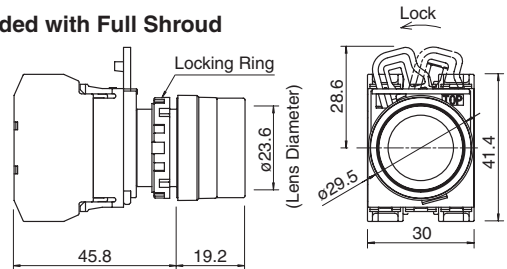

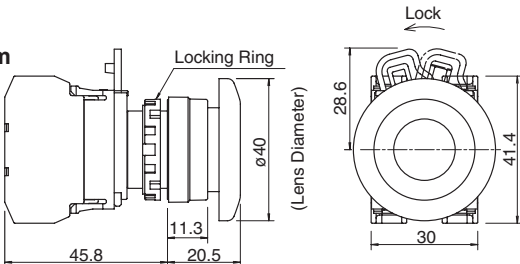

• **Mushroom**



All dimensions in mm.

Selector Switches with Plastic Bezel

Style					Knob Type						
											
No. of Positions	Contact Configuration	Contact Block Mounting Position	Operator Position			Maintained	Spring Return from Right	—	—		
			L	R	—						
90° 2-Position 	1NO (10)	1	NO		●		YW1S-2E10	YW1S-21E10	—	—	
		2									
		3									
	1NC (01)	1						YW1S-2E01	YW1S-21E01	—	—
		2									
		3	NC	●							
	2NO (20)	1	NO		●		YW1S-2E20	YW1S-21E20	—	—	
		2									
		3	NO		●						
	2NC (02)	1	NC	●			YW1S-2E02	YW1S-21E02	—	—	
		2									
		3	NC	●							
	1NO-1NC (11)	1	NO		●		YW1S-2E11	YW1S-21E11	—	—	
		2									
		3	NC	●							
	3NO (30)	1	NO		●		YW1S-2E30	YW1S-21E30	—	—	
		2	NO		●						
		3	NO		●						
3NC (03)	1	NC	●			YW1S-2E03	YW1S-21E03	—	—		
	2	NC	●								
	3	NC	●								
2NO-1NC (21)	1	NO		●		YW1S-2E21	YW1S-21E21	—	—		
	2	NO		●							
	3	NC	●								
1NO-2NC (12)	1	NO		●		YW1S-2E12	YW1S-21E12	—	—		
	2	NC	●								
	3	NC	●								
No. of Positions	Contact Configuration	Contact Block Mounting Position	Operator Position			Maintained	Spring Return from Right	Spring Return from Left	Spring Return Two-Way		
			L	C	R						
45° 3-Position 	2NO (20)	1	NO	●			YW1S-3E20	YW1S-31E20	YW1S-32E20	YW1S-33E20	
		2									
		3	NO			●					
	2NO (20N1)	1						YW1S-3E20N1	YW1S-31E20N1	YW1S-32E20N1	YW1S-33E20N1
		2	NO	●		●					
		3	NO			●					
	2NC (02)	1	NC					YW1S-3E02	YW1S-31E02	YW1S-32E02	YW1S-33E02
		2									
		3	NC								
	2NC (02N1)	1						YW1S-3E02N1	YW1S-31E02N1	YW1S-32E02N1	YW1S-33E02N1
		2	NC		●						
		3	NC								
	1NO-1NC (11)	1	NO	●			YW1S-3E11	YW1S-31E11	YW1S-32E11	YW1S-33E11	
		2									
		3	NC								
	1NO-1NC (11N1)	1	NC				YW1S-3E11N1	YW1S-31E11N1	YW1S-32E11N1	YW1S-33E11N1	
		2									
		3	NO			●					
	1NO-1NC (11N2)	1	NO	●			YW1S-3E11N2	YW1S-31E11N2	YW1S-32E11N2	YW1S-33E11N2	
		2	NC		●						
		3									
1NO-1NC (11N3)	1					YW1S-3E11N3	YW1S-31E11N3	YW1S-32E11N3	YW1S-33E11N3		
	2	NC		●							
	3	NO			●						
1NO-1NC (11N4)	1					YW1S-3E11N4	YW1S-31E11N4	YW1S-32E11N4	YW1S-33E11N4		
	2	NO	●		●						
	3	NC									
3NO (30)	1	NO	●			YW1S-3E30	YW1S-31E30	YW1S-32E30	YW1S-33E30		
	2	NO	●		●						
	3	NO			●						
3NC (03)	1	NC				YW1S-3E03	YW1S-31E03	YW1S-32E03	YW1S-33E03		
	2	NC		●							
	3	NC									
2NO-1NC (21)	1	NO	●			YW1S-3E21	YW1S-31E21	YW1S-32E21	YW1S-33E21		
	2	NC		●							
	3	NO			●						
1NO-2NC (12)	1	NC				YW1S-3E12	YW1S-31E12	YW1S-32E12	YW1S-33E12		
	2	NO	●		●						
	3	NC									

Selector Switches with Metal Bezel

Style				Knob Type							
90° 2-Position 	No. of Positions	Contact Configuration	Contact Block Mounting Position	Operator Position			Maintained	Spring Return from Right	—	—	
				L	R	—					
	1NO (10)	1	NO		●			YW4S-2E10	YW4S-21E10	—	—
		2									
		3									
	1NC (01)	1						YW4S-2E01	YW4S-21E01	—	—
		2									
		3	NC	●							
	2NO (20)	1	NO		●			YW4S-2E20	YW4S-21E20	—	—
		2									
3		NO		●							
2NC (02)	1	NC	●				YW4S-2E02	YW4S-21E02	—	—	
	2										
	3	NC	●								
1NO-1NC (11)	1	NO		●			YW4S-2E11	YW4S-21E11	—	—	
	2										
	3	NC	●								
3NO (30)	1	NO		●			YW4S-2E30	YW4S-21E30	—	—	
	2	NO		●							
	3	NO		●							
3NC (03)	1	NC	●				YW4S-2E03	YW4S-21E03	—	—	
	2	NC	●								
	3	NC	●								
2NO-1NC (21)	1	NO		●			YW4S-2E21	YW4S-21E21	—	—	
	2	NO		●							
	3	NC	●								
1NO-2NC (12)	1	NO		●			YW4S-2E12	YW4S-21E12	—	—	
	2	NC	●								
	3	NC	●								
45° 3-Position 	No. of Positions	Contact Configuration	Contact Block Mounting Position	Operator Position			Maintained	Spring Return from Right	Spring Return from Left	Spring Return Two-Way	
L				C	R						
2NO (20)	1	NO		●			YW4S-3E20	YW4S-31E20	YW4S-32E20	YW4S-33E20	
	2										
	3	NO				●					
2NO (20N1)	1	NO		●			YW4S-3E20N1	YW4S-31E20N1	YW4S-32E20N1	YW4S-33E20N1	
	2	NO		●							
	3	NO				●					
2NC (02)	1	NC				■	YW4S-3E02	YW4S-31E02	YW4S-32E02	YW4S-33E02	
	2					■					
	3	NC				■					
2NC (02N1)	1	NC				■	YW4S-3E02N1	YW4S-31E02N1	YW4S-32E02N1	YW4S-33E02N1	
	2	NC				■					
	3	NC				■					
1NO-1NC (11)	1	NO		●			YW4S-3E11	YW4S-31E11	YW4S-32E11	YW4S-33E11	
	2										
	3	NC				■					
1NO-1NC (11N1)	1	NC				■	YW4S-3E11N1	YW4S-31E11N1	YW4S-32E11N1	YW4S-33E11N1	
	2										
	3	NO				●					
1NO-1NC (11N2)	1	NO		●			YW4S-3E11N2	YW4S-31E11N2	YW4S-32E11N2	YW4S-33E11N2	
	2	NC				■					
	3										
1NO-1NC (11N3)	1						YW4S-3E11N3	YW4S-31E11N3	YW4S-32E11N3	YW4S-33E11N3	
	2	NC				■					
	3	NO				●					
1NO-1NC (11N4)	1	NO		●			YW4S-3E11N4	YW4S-31E11N4	YW4S-32E11N4	YW4S-33E11N4	
	2	NC				■					
	3	NC				■					
3NO (30)	1	NO		●			YW4S-3E30	YW4S-31E30	YW4S-32E30	YW4S-33E30	
	2	NO		●							
	3	NO		●							
3NC (03)	1	NC				■	YW4S-3E03	YW4S-31E03	YW4S-32E03	YW4S-33E03	
	2	NC				■					
	3	NC				■					
2NO-1NC (21)	1	NO		●			YW4S-3E21	YW4S-31E21	YW4S-32E21	YW4S-33E21	
	2	NC				■					
	3	NO				●					
1NO-2NC (12)	1	NC				■	YW4S-3E12	YW4S-31E12	YW4S-32E12	YW4S-33E12	
	2	NO		●							
	3	NC				■					

Contact Block Mounting Position

• **Selector Switch with Plastic Bezel**

Contact Block
Mounting Position

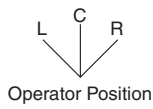

Dimensions

• **Selector Switch with Plastic Bezel**

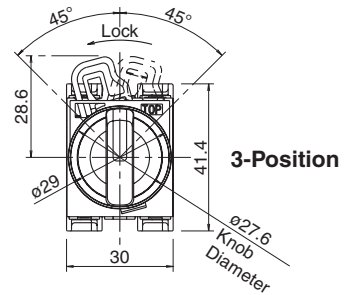
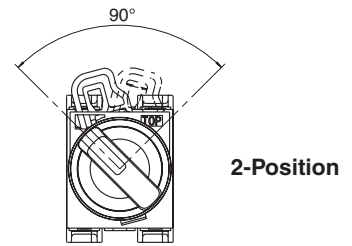
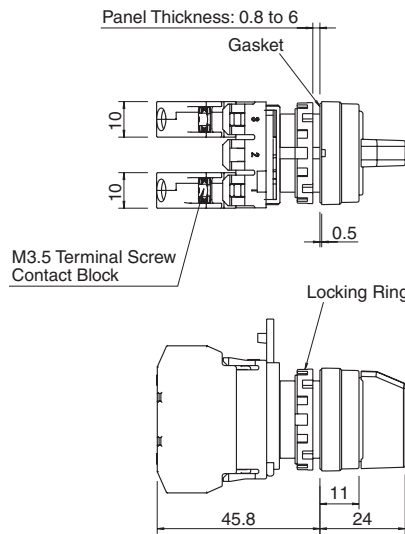

• **Selector Switch with Metal Bezel**

Contact Block
Mounting Position

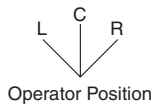



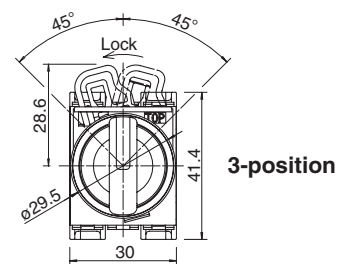
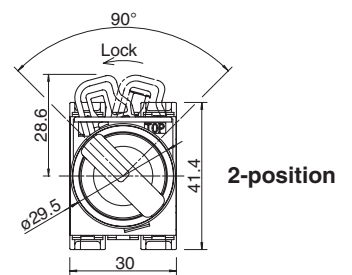
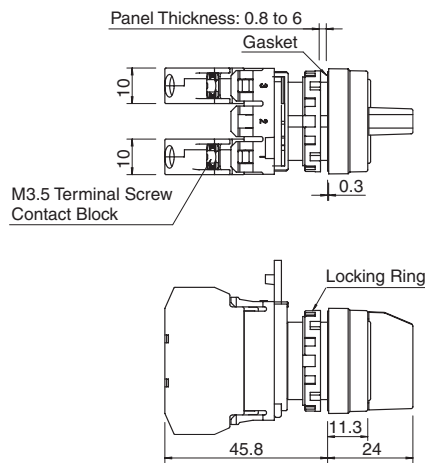

• **Selector Switch with Metal Bezel**





All dimensions in mm.

Key Selector Switches

No. of Positions	Contact Configuration	Contact Block Mounting Position		Operator Position		Type No.		
				L	R	Plastic Bezel	Metal Bezel	
								
90° 2-position Maintained 	1NO (10)	1	NO		●	YW1K-2AE10	YW4K-2AE10	
		2						
		3						
	1NC (01)	1					YW1K-2AE01	YW4K-2AE01
		2						
		3	NC	●				
	2NO (20)	1	NO			●	YW1K-2AE20	YW4K-2AE20
		2						
		3	NO		●			
	2NC (02)	1	NC	●			YW1K-2AE02	YW4K-2AE02
		2						
		3	NC	●				
	1NO-1NC (11)	1	NO			●	YW1K-2AE11	YW4K-2AE11
		2						
		3	NC	●				
	3NO (30)	1	NO			●	YW1K-2AE30	YW4K-2AE30
		2	NO		●			
		3	NO		●			
3NC (03)	1	NC	●			YW1K-2AE03	YW4K-2AE03	
	2	NC	●					
	3	NC	●					
2NO-1NC (21)	1	NO			●	YW1K-2AE21	YW4K-2AE21	
	2	NO		●				
	3	NC	●					
1NO-2NC (12)	1	NO			●	YW1K-2AE12	YW4K-2AE12	
	2	NC	●					
	3	NC	●					
90° 2-position Spring Return from Right 	1NO (10)	1	NO		●	YW1K-21BE10	YW4K-21BE10	
		2						
		3						
	1NC (01)	1					YW1K-21BE01	YW4K-21BE01
		2						
		3	NC	●				
	2NO (20)	1	NO			●	YW1K-21BE20	YW4K-21BE20
		2						
		3	NO		●			
	2NC (02)	1	NC	●			YW1K-21BE02	YW4K-21BE02
		2						
		3	NC	●				
	1NO-1NC (11)	1	NO			●	YW1K-21BE11	YW4K-21BE11
		2						
		3	NC	●				
	3NO (30)	1	NO			●	YW1K-21BE30	YW4K-21BE30
		2	NO		●			
		3	NO		●			
3NC (03)	1	NC	●			YW1K-21BE03	YW4K-21BE03	
	2	NC	●					
	3	NC	●					
2NO-1NC (21)	1	NO			●	YW1K-21BE21	YW4K-21BE21	
	2	NO		●				
	3	NC	●					
1NO-2NC (12)	1	NO			●	YW1K-21BE12	YW4K-21BE12	
	2	NC	●					
	3	NC	●					

- On the spring-returned types, the key can be removed only from the maintained position. On the maintained types, the key can be removed from every position. Key retained positions are also available. See the ordering information shown on page 20.
- Each key selector switch is supplied with two identical keys.

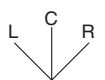
No. of Positions	Contact Configuration	Contact Block Mounting Position		Operator Position			Type No.		
				L	C	R	Plastic Bezel	Metal Bezel	
									
45° 3-position Maintained 	2NO (20)	1	NO	●			YW1K-3AE20	YW4K-3AE20	
		2							
		3	NO			●			
	2NO (20N1)	1						YW1K-3AE20N1	YW4K-3AE20N1
		2	NO	●		●			
		3	NO			●			
	2NC (02)	1	NC		■		YW1K-3AE02	YW4K-3AE02	
		2							
		3	NC	■					
	2NC (02N1)	1					YW1K-3AE02N1	YW4K-3AE02N1	
		2	NC		●				
		3	NC	■					
	1NO-1NC (11)	1	NO	●			YW1K-3AE11	YW4K-3AE11	
		2							
		3	NC	■					
	1NO-1NC (11N1)	1	NC			■		YW1K-3AE11N1	YW4K-3AE11N1
		2					●		
		3	NO				●		
	1NO-1NC (11N2)	1	NO	●			YW1K-3AE11N2	YW4K-3AE11N2	
		2	NC		●				
		3							
	1NO-1NC (11N3)	1					YW1K-3AE11N3	YW4K-3AE11N3	
		2	NC		●				
		3	NO			●			
	1NO-1NC (11N4)	1					YW1K-3AE11N4	YW4K-3AE11N4	
		2	NO	●		●			
		3	NC	■					
	3NO (30)	1	NO	●			YW1K-3AE30	YW4K-3AE30	
2		NO	●		●				
3		NO			●				
3NC (03)	1	NC		■		YW1K-3AE03	YW4K-3AE03		
	2	NC		●					
	3	NC	■						
2NO-1NC (21)	1	NO	●			YW1K-3AE21	YW4K-3AE21		
	2	NC		●					
	3	NO			●				
1NO-2NC (12)	1	NC		■		YW1K-3AE12	YW4K-3AE12		
	2	NO	●		●				
	3	NC	■						

- On the maintained types, the key can be removed from every position. Key retained positions are also available. See the ordering information shown below.
- Each key selector switch is supplied with two identical keys.



Ordering Information

YW1K-2 A E21

- Key removal position code
- 2-position
 - A: Removable in all positions
 - B: Removable in left only
 - C: Removable in right only
 - 3-position
 - A: Removable in all positions
 - B: Removable in left and center
 - C: Removable in right and center
 - D: Removable in center only
 - E: Removable in right and left
 - G: Removable in left only
 - H: Removable in right only

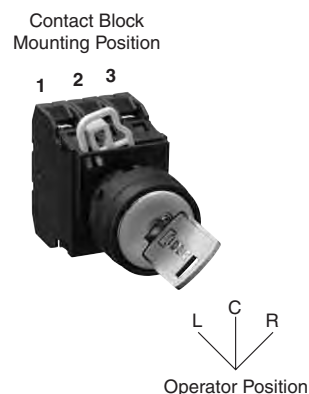

Contact Block Mounting Position





No. of Positions	Contact Configuration	Contact Block Mounting Position		Operator Position			Type No.		
				L	C	R	Plastic Bezel	Metal Bezel	
									
45° 3-position Spring Return from Right 	2NO (20)	1	NO	●			YW1K-31BE20	YW4K-31BE20	
		2							
		3	NO			●			
	2NO (20N1)	1						YW1K-31BE20N1	YW4K-31BE20N1
		2	NO	●		●			
		3	NO			●			
	2NC (02)	1	NC			■		YW1K-31BE02	YW4K-31BE02
		2							
		3	NC	■					
	2NC (02N1)	1						YW1K-31BE02N1	YW4K-31BE02N1
		2	NC		●				
		3	NC	■					
	1NO-1NC (11)	1	NO	●				YW1K-31BE11	YW4K-31BE11
		2							
		3	NC	■					
	1NO-1NC (11N1)	1	NC			■		YW1K-31BE11N1	YW4K-31BE11N1
		2							
		3	NO			●			
	1NO-1NC (11N2)	1	NO	●				YW1K-31BE11N2	YW4K-31BE11N2
		2	NC		●				
		3							
	1NO-1NC (11N3)	1						YW1K-31BE11N3	YW4K-31BE11N3
		2	NC		●				
		3	NO			●			
	1NO-1NC (11N4)	1	NO	●				YW1K-31BE11N4	YW4K-31BE11N4
		2	NO	●		●			
		3	NC	■					
	3NO (30)	1	NO	●				YW1K-31BE30	YW4K-31BE30
2		NO	●		●				
3		NO			●				
3NC (03)	1	NC			■		YW1K-31BE03	YW4K-31BE03	
	2	NC		●					
	3	NC	■						
2NO-1NC (21)	1	NO	●				YW1K-31BE21	YW4K-31BE21	
	2	NC		●					
	3	NO			●				
1NO-2NC (12)	1	NC			■		YW1K-31BE12	YW4K-31BE12	
	2	NO	●		●				
	3	NC	■						

- On the spring-returned types, the key can be removed only from the maintained position. Key retained positions are also available. See the ordering information shown on page 20.
- Each key selector switch is supplied with two identical keys.

ø22 YW Series Control Units

No. of Positions	Contact Configuration	Contact Block Mounting Position		Operator Position			Type No.		
				L	C	R	Plastic Bezel	Metal Bezel	
									
45° 3-position Spring Return from Left 	2NO (20)	1	NO	●			YW1K-32CE20	YW4K-32CE20	
		2							
		3	NO			●			
	2NO (20N1)	1						YW1K-32CE20N1	YW4K-32CE20N1
		2	NO	●		●			
		3	NO			●			
	2NC (02)	1	NC		■			YW1K-32CE02	YW4K-32CE02
		2							
		3	NC	■					
	2NC (02N1)	1						YW1K-32CE02N1	YW4K-32CE02N1
		2	NC		●				
		3	NC	■					
	1NO-1NC (11)	1	NO	●				YW1K-32CE11	YW4K-32CE11
		2							
		3	NC	■					
	1NO-1NC (11N1)	1	NC			■		YW1K-32CE11N1	YW4K-32CE11N1
		2							
		3	NO			●			
	1NO-1NC (11N2)	1	NO	●				YW1K-32CE11N2	YW4K-32CE11N2
		2	NC		●				
		3							
	1NO-1NC (11N3)	1						YW1K-32CE11N3	YW4K-32CE11N3
		2	NC		●				
		3	NO			●			
1NO-1NC (11N4)	1						YW1K-32CE11N4	YW4K-32CE11N4	
	2	NO	●		●				
	3	NC	■						
3NO (30)	1	NO	●				YW1K-32CE30	YW4K-32CE30	
	2	NO	●		●				
	3	NO			●				
3NC (03)	1	NC		■			YW1K-32CE03	YW4K-32CE03	
	2	NC		●					
	3	NC	■						
2NO-1NC (21)	1	NO	●				YW1K-32CE21	YW4K-32CE21	
	2	NC		●					
	3	NO			●				
1NO-2NC (12)	1	NC		■			YW1K-32CE12	YW4K-32CE12	
	2	NO	●		●				
	3	NC	■						

- On the spring-returned types, the key can be removed only from the maintained position. Key retained positions are also available. See the ordering information shown on page 20.
- Each key selector switch is supplied with two identical keys.

No. of Positions	Contact Configuration	Contact Block Mounting Position		Operator Position			Type No.		
				L	C	R	Plastic Bezel	Metal Bezel	
									
<div style="display: flex; align-items: center;"> <div style="margin-right: 10px;"> <p>45° 3-position Spring Return Two-way</p>  </div> </div>	2NO (20)	1	NO	●			YW1K-33DE20	YW4K-33DE20	
		2							
		3	NO			●			
	2NO (20N1)	1						YW1K-33DE20N1	YW4K-33DE20N1
		2	NO	●		●			
		3	NO			●			
	2NC (02)	1	NC			■		YW1K-33DE02	YW4K-33DE02
		2							
		3	NC	■					
	2NC (02N1)	1						YW1K-33DE02N1	YW4K-33DE02N1
		2	NC		●				
		3	NC	■					
	1NO-1NC (11)	1	NO	●				YW1K-33DE11	YW4K-33DE11
		2							
		3	NC	■					
	1NO-1NC (11N1)	1	NC			■		YW1K-33DE11N1	YW4K-33DE11N1
		2							
		3	NO			●			
	1NO-1NC (11N2)	1	NO	●				YW1K-33DE11N2	YW4K-33DE11N2
		2	NC		●				
		3							
	1NO-1NC (11N3)	1						YW1K-33DE11N3	YW4K-33DE11N3
		2	NC		●				
		3	NO			●			
	1NO-1NC (11N4)	1	NO	●				YW1K-33DE11N4	YW4K-33DE11N4
		2	NO	●		●			
		3	NC	■					
	3NO (30)	1	NO	●				YW1K-33DE30	YW4K-33DE30
2		NO	●		●				
3		NO			●				
3NC (03)	1	NC			■		YW1K-33DE03	YW4K-33DE03	
	2	NC		●					
	3	NC	■						
2NO-1NC (21)	1	NO	●				YW1K-33DE21	YW4K-33DE21	
	2	NC		●					
	3	NO			●				
1NO-2NC (12)	1	NC			■		YW1K-33DE12	YW4K-33DE12	
	2	NO	●		●				
	3	NC	■						

- On the spring-returned types, the key can be removed only from the maintained position. Key retained positions are also available. See the ordering information shown on page 20.
- Each key selector switch is supplied with two identical keys.

Dimensions (Key Selector Switch)

• Plastic Bezel

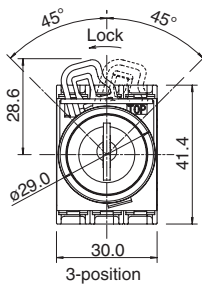
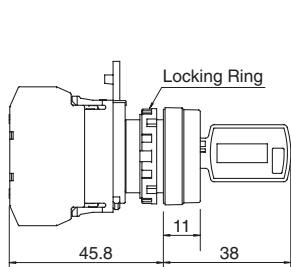
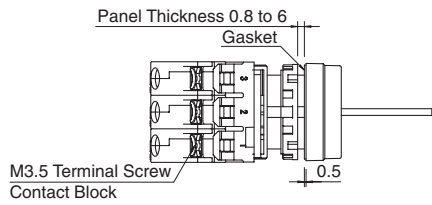



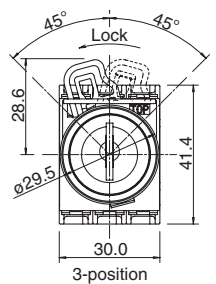
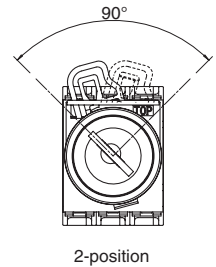
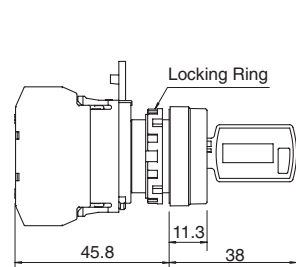
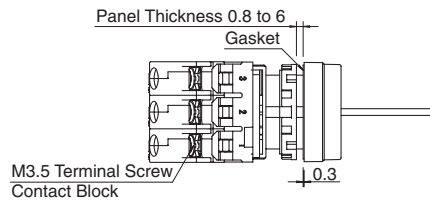





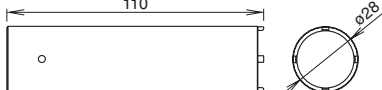

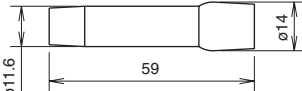

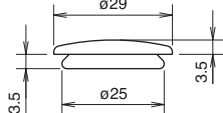

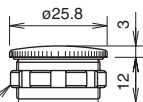

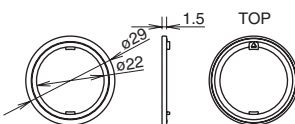



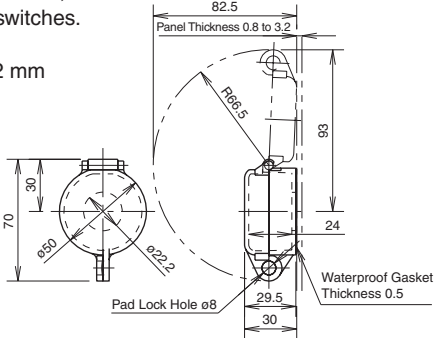

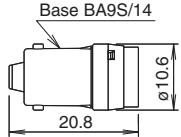
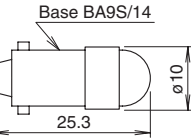
• Metal Bezel

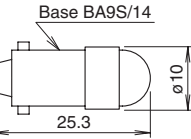

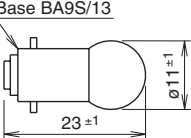
All dimensions in mm.

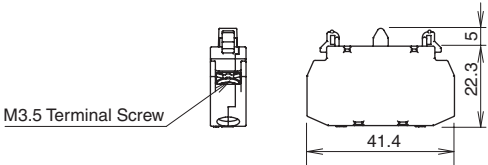
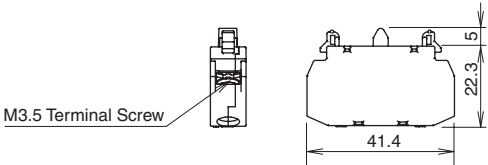
Accessories

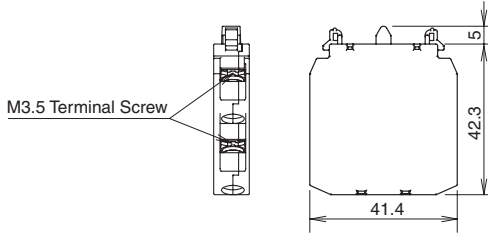
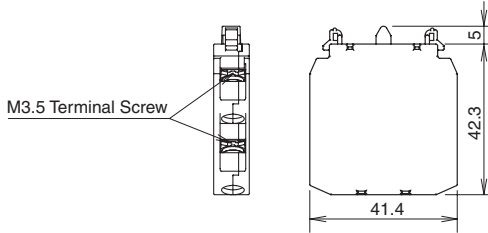
Name & Shape	Ordering Type No.	Description & Dimensions (mm)	Package Quantity
	MW9Z-T1	Metallic tool used to tighten the plastic locking ring when installing the YW series control unit in a panel. 	1
	OR-55	Made of rubber. Used for replacing lamps. 	1
	OB-31PN05	Used for plugging unused mounting holes in the panel. Color: Black 	5
	LW9Z-BM	Used for plugging unused mounting holes in the panel. Weight: Approx. 18g 	1
	HW9Z-RLPN10	Prevents rotation of switches in panel. Mainly used with selector switches when no nameplate is used. With waterproof gasket (IP65). Made of plastic (black). Applicable panel thickness: 1.2 to 4.5 mm 	10

Name & Shape	Ordering Type No.	Description & Dimensions (mm)		Package Quantity		
	HW9Z-KL1	Plastic hinged cover to protect pushbuttons, illuminated pushbuttons, or selector switches. Degree of protection: IP65. Applicable panel thickness: 0.8 to 3.2 mm 		1		
	LSED-6②	6V AC/DC	Specify a color code in place of ② in the Type No.: A (amber), G (green), PW (pure white), R (red), S (blue), Y (yellow) Applicable units: • LED illuminated pilot lights • LED illuminated pushbuttons		1	
	LSED-1②	12V AC/DC				
	LSED-2②	24V AC/DC				
	LSED-H②	110V AC/DC	For the rated current, see page 4. Note: Yellow LED lamps are used for white illumination of pilot lights and illuminated push-buttons.		1	
	LSED-M3②	230/240V AC/DC				
	LS-T6P	6.3V, 1W	One pack contains 100 incandescent lamps.		100	
	LS-T8P	18V, 1W				
	LS-T3P	30V, 1W				
	YW-E10P	Contact: 1NO			10	
	YW-E01P	Contact: 1NC				
	YW-EW20P	Contact: 2NO			10	
	YW-EW11P	Contact: 1NO-1NC				
	YW-EW02P	Contact: 2NC				Note: Double contact blocks cannot be used on emergency stop switches.
	YW9Z-SK00PN02			2		

Ø22 YW Series Control Units

Buttons, Lenses, and Marking Plates

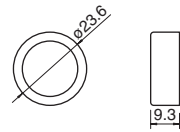
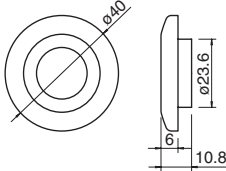
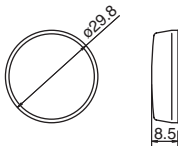
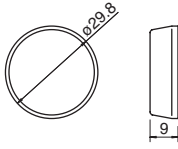
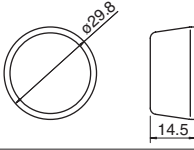
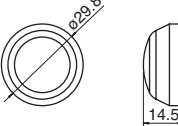
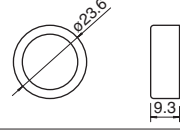
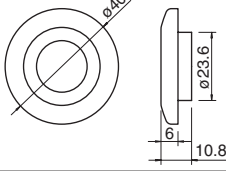
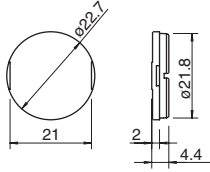
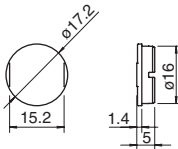
Name	Style	Ordering Type No.	① ② Color Code	Dimensions (mm)	Package Quantity
Button (for pushbuttons)	Extended	YW9Z-B12①PN10	B: black G: green R: red S: blue W: white Y: yellow		10
	Mushroom Ø40mm	YW9Z-B14①PN10			
Lens (for pilot lights)	Flush	YW9Z-PL11②PN10	A: amber C: clear G: green R: red S: blue W: white Y: yellow		10
	Flush Marking	YW9Z-PL11B②PN10	A: :amber C: clear G: green R: red S: blue Y: yellow		10
	Extended	YW9Z-PL12T②PN10	A: amber C: clear G: green R: red S: blue W: white Y: yellow		10
	Dome	YW9Z-PL12②PN10		10	
Lens (for illuminated pushbuttons)	Extended	YW9Z-L12②PN10	A: amber C: clear G: green R: red S: blue Y: yellow		10
	Mushroom Ø40mm	YW9Z-L14②PN10			
Marking Plate (for pilot lights)	—	YW9Z-PP12PN10	—		10
Marking Plate (for illuminated pushbuttons)	—	YW9Z-P12PN10	—		10

Nameplates

• HWAM, HWAQ, HWAS, and HWAV

Type	Legend	Material	Type No.	Ordering Type No.	Package Quantity	Dimensions (mm)
HWAM	Order marking plate separately.	Plastic (black) 1.5 mm thick	HWAM	HWAM	1	
				HWAMPN10	10	
HWAQ	Order marking plate separately.	Plastic (black) 1.5 mm thick	HWAQ	HWAQ	1	
				HWAQPN10	10	
HWAS	Blank	Plastic (black) 1.5 mm thick	HWAS-0	HWAS-0	1	
				HWAS-0PN10	10	
HWAV	Blank	Plastic (yellow) 1.5 mm thick	HWAV-0	HWAV-0	1	
	EMERGENCY STOP		HWAV-27	HWAV-27	1	

• Making Plate

Description	Material	Type No.	Ordering Type No.	Package Quantity	Dimensions (mm)
HWNP	Aluminum (black) 1.0 mm thick	HWNP-*	HWNP-*	1	• White legend on black background.
			HWNP-*PN10	10	

• Specify a legend code in place of * in the Ordering Type No.

Legends

Code	Legend
0	(blank)
1	ON
2	OFF
3	START
4	STOP
31	OFF-ON
35	HAND-AUTO
53	HAND-OFF-AUTO

• Installing the marking plate on a nameplate

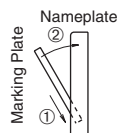



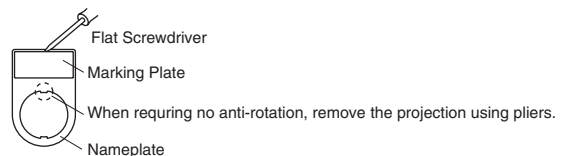



• To remove the marking plate, insert the flat screwdriver between the marking plate and nameplate.

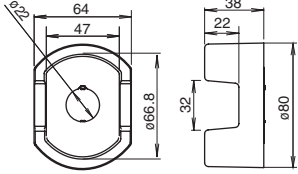

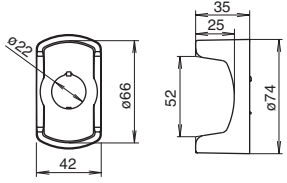
Note: When using an nameplate, the mounting panel thickness is decreased by 1.5 mm.

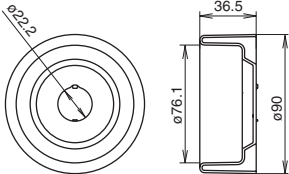
EMO Switch Guards

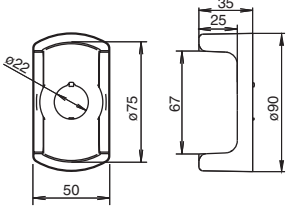
Type No. & Appearance	Dimensions (mm)	Type No. & Appearance	Dimensions (mm)
HW9Z-KG1  EMO Switch Guard SEMI S2 compliant (Note 1)		HW9Z-KG3  EMO Switch Guard SEMI S2 compliant (Note 2)	
HW9Z-KG2  EMO Switch Guard SEMI S2 compliant (Note 1) SEMATECH compliant (Note 3)		HW9Z-KG4  EMO Switch Guard SEMI S2 compliant (Note 2) SEMATECH compliant (Note 3)	

Material: Polyamide (PA6)
 Color: Yellow, Munsell 2.5Y 8/10 equivalent
 Degree of protection: IP65

• Degree of protection IP65 applies to the combination of an emergency stop switch and an EMO switch guard.

Note 1: SEMI S2-0703 12.5.1 compliant.

Note 2: The combination of IDEC's emergency stop switches and EMO switch guards are approved by TÜV Rheinland for compliance with SEMI S2 standard.

Note 3: SEMATECH Application Guide for SEMI S2-93, 12.4.c. compliant.

Separate DIN Rail Mounting Type Transformer

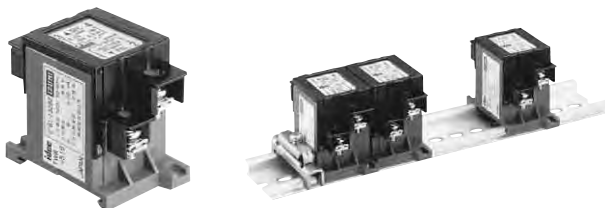

Primary Voltage (50/60 Hz)	Type No.	Applicable Lamp Rating
110V AC	TWR516	One full voltage type illuminated unit containing LED lamp LSED-6 (6V AC/DC) or incandescent lamp LS-T6 (6.3V)
115V AC	TWR5116	
120V AC	TWR5126	
220V AC	TWR526	
230V AC	TWR5236	
240V AC	TWR5246	
380V AC	TWR5386	
440V AC	TWR546	
480V AC	TWR5486	

• Dimensions (mm)

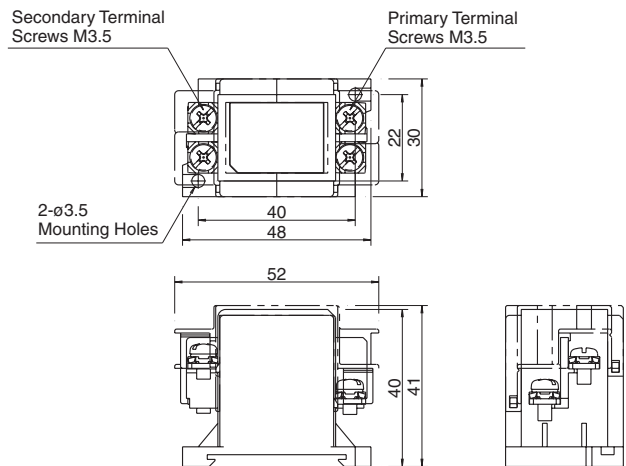

Note: Finger-safe terminal cover is supplied with the transformer.

Safety Precautions

- Turn off the power to the YW series control units before starting installation, removal, wiring, maintenance, and inspection of the products. Failure to turn power off may cause electrical shocks or fire hazard.
- To avoid burning your hand, use the lamp holder tool when replacing lamps.

- For wiring, use wires of a proper size to meet the voltage and current requirements. Tighten the M3.5 terminal screws to a tightening torque of 1.0 N·m. Failure to tighten the terminal screws may cause overheating and fire.

Instructions

Panel Mounting

- Remove the contact block from the operator (for pilot lights, remove the transformer or full voltage unit from the pilot light). Remove the locking ring from the operator. Insert the operator into the panel cut-out from the front, tighten the locking ring from the back, then install the contact block to the operator.
- **Removing and Installing the Contact Block**



- ① Pull up the locking lever.
- ② Turn the lever to the left.
- ③ Pull out the contact block.

1. To remove the operator from the contact block, pull up the locking lever and turn it to the left. Then the operator can be pulled out.
2. To reinstall, place the TOP marking on the operator and the idec marking on the contact block mounting adapter in the same direction, and insert the operator into the contact block mounting adapter. Then turn the locking lever to the right.



• Removing and Installing the Transformer Unit

1. Insert a flat screwdriver (5 mm wide at maximum) into the latch hole on the transformer unit as shown in the photo below, and disengage the latch. Then pull out the operator.
2. To reinstall, place the TOP marking on the operator and the latch in the same direction, and push the operator into the transformer unit.

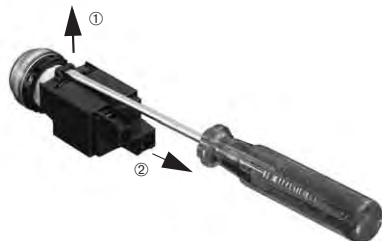

• Removing the Full Voltage Unit

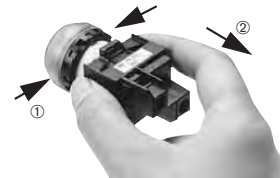

1. To remove the full voltage unit, squeeze the full voltage unit from both sides to disengage the latch as shown, and pull it out. Like the transformer unit, the full voltage unit can also be pulled out by inserting a flat screwdriver into the latch hole as shown.
2. To reinstall, place the TOP markings on the operator and the latch on the full voltage unit in the same direction, and insert the operator into the full voltage unit.

• Notes for Panel Mounting

1. Use the optional locking ring wrench (MW9Z-T1) to mount the operator onto a panel. Tightening torque must not exceed 2.0 N·m. Do not use pliers. Excessive tightening will damage the locking ring.
2. For contact blocks and transformers housing LED and incandescent lamps, make sure not to press the lamps too hard, otherwise the lamp socket may be damaged.

Insertion Order of Lens and Marking Plate

• Illuminated Pushbutton

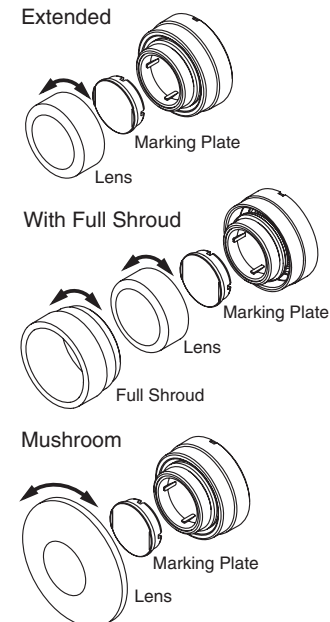

• Pilot Light

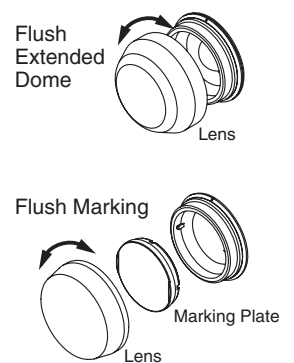

Marking

For YW series pilot lights and illuminated pushbuttons, legends and symbols can be engraved on built-in marking plates, or printed mylar film can be inserted under the lens for labeling purposes. Mylar film is not supplied with the control units and must be supplied by the end user.

• Built-in Marking Plate and Marking Film Size

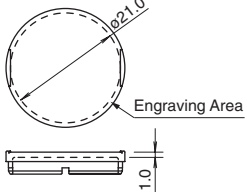
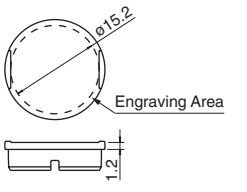
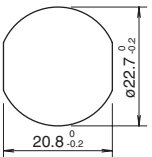
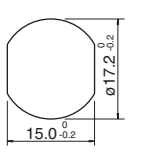
Unit	Pilot Light	Illuminated Pushbutton
Built-in Marking Plate		
	Engraving depth: 0.5 mm maximum Marking plate material: White acrylic	
Applicable Marking Film		
	0.1-mm-thick × 2 sheets or 0.2-mm-thick × 1 sheet Film material: Mylar (recommended) Note: Marking film is not supplied with the pilot light or illuminated pushbutton.	

• Replacement (LED and incandescent lamps)

Lamps can be replaced using the lamp holder tool (OR-55) from the front of the panel, or by removing the contact block from the operator unit.

• Removing the Lamp from the Front of the Panel



To remove, gently insert the lamp holder tool onto the lamp head. Then push slightly, and turn the lamp holder tool to the left.

• Installing the Lamp from the Front of the Panel

1. To install, insert the lamp head into the lamp holder tool, and hold the lamp as shown in the figure below.

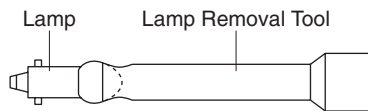

2. Place the pins on the lamp base to the grooves in the lamp socket. Insert the lamp and turn it to the right.

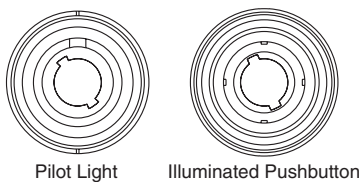

Note: LED lamps in unibody type pilot lights cannot be replaced.

Removing Contact Blocks and Full Voltage Adapter

Insert a flat screwdriver between the latch and contact block mounting adapter, and disengage the latch.



Make sure to remove the lamp and contact blocks before removing the full voltage adapter.

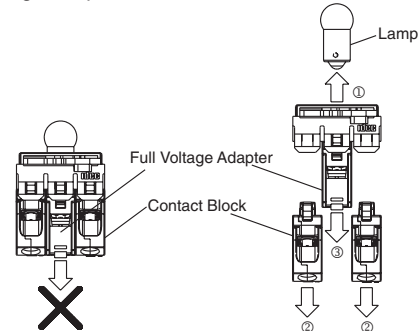

Tightening Torque for Terminal Screws

Tighten terminal screws to a torque of 1.0 N·m.

Anti-rotation Ring and Mounting Panel

Turn the TOP marking on the operator and the ▲ mark on the anti-rotation ring to the recess on the mounting panel.

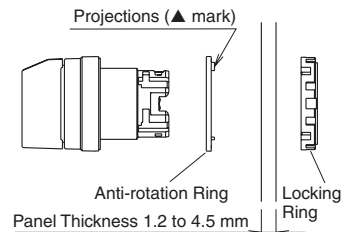

Mounting Panel Thickness

The mounting panel must be 0.8 to 6.0 mm in thickness. When optional accessories are added, the applicable panel thickness changes as shown below.

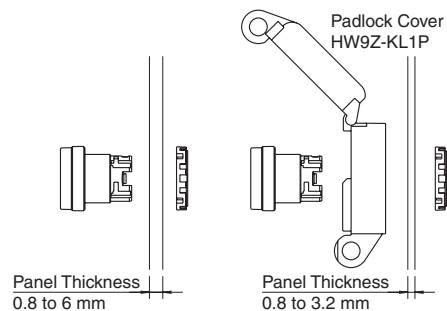

Contact Bounce

When pressing or turning the operator, the NC and NO contacts will bounce. When designing a control circuit, take the contact bounce time into consideration (reference value: 20 ms).

Precautions for Noise

When using the unibody pilot light in an environment where it is subjected to noise, connect a noise suppressor across terminals X1 and X2 as shown below.

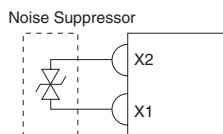

Key Selector Switch

Before operation, ensure that the key is inserted into the key hole completely. Operating the key selector switch with a loose key will cause damage to the key selector switch.

Nameplate

When anti-rotation is not required, remove the projection from the nameplate using pliers.

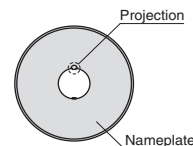

Handling

Do not expose the switch to excessive shock and vibration, otherwise the switch may be deformed or damaged, causing malfunction or operation failure.



Instructions

LED Illumination

LED lamps consist of semiconductors. If the applied voltage exceeds the rated voltage, LED elements deteriorate due to over-heat, resulting in significant decrease in brightness, hue change, or failure of lighting. Also, if extraneous noise, transient voltage, or transient current is applied to the circuit, similar effects will be caused. When using LED lamps, observe the following instructions.

• Rated Voltage

The LED illuminated units are rated at 6V, 12V, 24V, 110V, or 230/240V AC/DC, and can be used within $\pm 10\%$ the rated voltage of either AC or DC, except the 230/240V AC/DC types can be used on 250V AC/DC maximum.

• DC Power

1. Switching power supply
Regulated voltage from a switching power supply is best suited. Make sure to use within the rated voltage of the LED lamp.
2. Rechargeable battery
Note that the battery voltage may exceed the rated voltage of the LED lamp while the battery is being charged and immediately after the charging is complete. Be sure to use the LED lamp on a voltage of $\pm 10\%$ the rated voltage, except the 230/240V AC/DC types on 250V AC/DC maximum.
3. Full-wave rectification
Since the LED lamp is AC/DC compatible, a diode bridge for rectification is not necessary. If the LED lamp is used on a full-wave rectification current through a diode bridge, the rectifier diodes will reduce the voltage, resulting in lower brightness.
4. Single-phase half-wave rectification
This is not suitable for the power source of LED lamps. Use constant-voltage DC power.

• Noise

LED elements deteriorate due to extraneous noise, resulting in significant decrease in brightness, hue change, or failure of lighting. When such effects are anticipated, take a protection measure shown below, such as RC elements or a surge absorber.

[Protection Example 1] For AC circuit

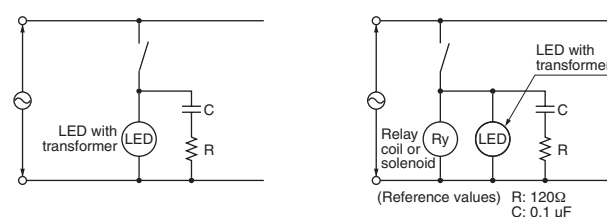

[Protection Example 2] For DC circuit

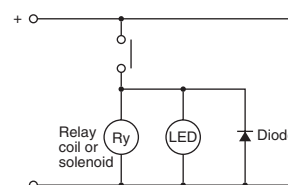

• Countermeasures against Dim Lighting

1. Leakage current through transistors or a contact protection circuit may cause the LED lamp to illuminate dimly even when the output is off.
2. When the LED lamp is illuminated by a transistor output, take the following measure.

[Circuit Example]

Connect shunt resistor R in parallel with the LED lamp.

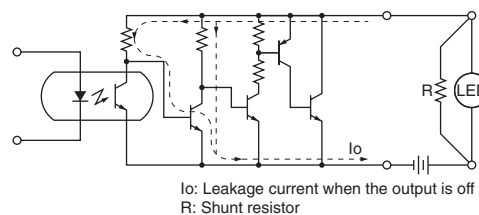

Ordering Information

- When ordering, specify the Type No. and quantity.
- Replacement contact blocks are supplied in a package containing 10 pieces.

Specifications and other descriptions in this catalog are subject to change without notice.



IDEC CORPORATION

7-31, Nishi-Miyahara 1-Chome, Yodogawa-ku, Osaka 532-8550, Japan
Tel: +81-6-6398-2571, Fax: +81-6-6392-9731
E-mail: marketing@idec.co.jp

IDEC CORPORATION (USA)

1175 Elko Drive, Sunnyvale, CA 94089-2209, USA
Tel: +1-408-747-0550 / (800) 262-IDECE (4332)
Fax: +1-408-744-9055 / (800) 635-6246
E-mail: opencontact@idec.com

IDEC CANADA LIMITED

3155 Pepper Mill Court, Unit 4, Mississauga,
Ontario, L5L 4X7, Canada
Tel: +1-905-890-8561, Toll Free: (888) 317-4332
Fax: +1-905-890-8562
E-mail: sales@ca.idec.com

IDEC AUSTRALIA PTY. LTD.

2/3 Macro Court, Rowville, Victoria 3178, Australia
Tel: +61-3-9763-3244, Toll Free: 1800-68-4332
Fax: +61-3-9763-3255
E-mail: sales@au.idec.com

IDEC ELECTRONICS LIMITED

Unit 2, Beechwood, Chineham Business Park,
Basingstoke, Hampshire RG24 8WA, UK
Tel: +44-1256-321000, Fax: +44-1256-327755
E-mail: sales@uk.idec.com

IDEC ELEKTROTECHNIK GmbH

Wendenstrasse 331, 20537 Hamburg, Germany
Tel: +49-40-25 30 54 - 0, Fax: +49-40-25 30 54 - 24
E-mail: service@idec.de

IDEC (SHANGHAI) CORPORATION

Room 608-609, 6F, Gangtai Plaza, No. 700,
Yan'an East Road, Shanghai 200001, PRC
Tel: +86-21-5353-1000, Fax: +86-21-5353-1263
E-mail: idec@cn.idec.com

IDEC (BEIJING) CORPORATION

Room 211B, Tower B, The Grand Pacific Building,
8A Guanghua Road, Chaoyang District,
Beijing 100026, PRC
Tel: +86-10-6581-6131, Fax: +86-10-6581-5119

IDEC (SHENZHEN) CORPORATION

Unit AB-3B2, Tian Xiang Building, Tian'an Cyber Park,
Fu Tian District, Shenzhen, Guang Dong 518040, PRC
Tel: +86-755-8356-2977, Fax: +86-755-8356-2944

IDEC IZUMI (H.K.) CO., LTD.

Units 11-15, Level 27, Tower 1,
Millennium City 1, 388 Kwun Tong Road,
Kwun Tong, Kowloon, Hong Kong
Tel: +852-2803-8989, Fax: +852-2565-0171
E-mail: info@hk.idec.com

IDEC TAIWAN CORPORATION

8F-1, No. 79, Hsin Tai Wu Road, Sec. 1,
Hsi-Chih, Taipei County, Taiwan
Tel: +886-2-2698-3929, Fax: +886-2-2698-3931
E-mail: service@tw.idec.com

IDEC IZUMI ASIA PTE. LTD.

No. 31, Tannery Lane #05-01,
HB Centre 2, Singapore 347788
Tel: +65-6746-1155, Fax: +65-6844-5995
E-mail: info@sg.idec.com