

SERIES 1660 - SINGLE AND DOUBLE-POLE PUSHBUTTON SWITCHES

TO 16 (4) A 250 V AC



PRODUCT FEATURES

- ◆ Illuminated and non-illuminated pushbutton switch
- ◆ Proven jump contact switching system (double interrupting)
- ◆ Opening and closing speed independent of the actuating speed
- ◆ Product-dependent with external lamp connection

ON REQUEST

- ◆ Other colors
- ◆ Other printing variants
- ◆ Other connection types
- ◆ Other lamp variants
- ◆ Cable assembly

Mechanical life endurance	5E4
Contact resistance (new condition)	< 100 mOhm (1 A 12 V DC)
Insulation resistance (new condition)	> 100 MOhm (500 V DC)
Voltage strength at 250 V	1 500 V function insulation / basic insulation 3 000 V reinforced insulation 500 V small contact distance
Proof tracking	250 PTI
Insulation spacing	acc. to EN 61058 for reinforced or double insulation
Protection type	IP 40
Ambient temperature	connection side -20 °C ... +85 °C actuating side -20 °C ... +55 °C
Flammability	UL 94 V-2
Heat and fire resistance	850 °C (category D)
Material	actuator PA / PC (product-dependent) housing PA / PA glass fiber-reinforced (product-dependent) connections Cu / silver-plated
Plug force of the terminals	≤ 80 N
Approval marks	
Suitable for appliances of protection class II	



ROCKER SWITCHES

PUSHBUTTON SWITCHES

TOGGLE SWITCHES

SLIDE SWITCHES

ROTARY SWITCHES

FOOT SWITCHES

POWER TOOL SWITCHES

TACT AND KEY SWITCHES



SNAP-ACTION SWITCHES

MICRO-SIGNAL SWITCHES

SENSORS

SERIES 1660 - SINGLE AND DOUBLE-POLE PUSHBUTTON SWITCHES

TO 16 (4) A 250 V AC

 single-pole		Voltage lamp in V	Actuator color / printing	Housing color	16 (4) A 250 V AC 1E4	16 (4) A 250 V AC	12 (4) A 250 V AC 1E4	12 A 250 V AC 1/2 HP	12 A 125 V AC 1/6 HP	Connection type	Connection description	Contact distance in mm	Contact material	Miscellaneous	Stock version
Normally open contact (SPNO)															
1665.3101	230			●							6.3 / 2 x 4.8	≈ 3	Ag	external lamp connection	
1665.3102	230			●							6.3 / 2 x 4.8	≈ 3	Ag	external lamp connection	●
ON/OFF switch (SPST)															
1662.0201				●							6.3	≈ 3	Ag		●
1662.0203				●							6.3	≈ 3	Ag		
Normally open contact (SPNO)															
1662.0101				●							6.3	≈ 3	Ag		●
1662.0102				●							6.3	≈ 3	Ag		
Changeover switch (SPDT momentary)															
1664.0101					●						4.8	< 3	Ag		●
 double-pole		Voltage lamp in V	Actuator color / printing	Housing color	16 (4) A 250 V AC 1E4	16 (4) A 250 V AC	12 (4) A 250 V AC 1E4	12 A 250 V AC 1/2 HP	12 A 125 V AC 1/6 HP	Connection type	Connection description	Contact distance in mm	Contact material	Miscellaneous	Stock version
ON/OFF switch (SPST)															
1660.0201	230			●							6.3	≈ 3	Ag		●
1660.0202	230			●							6.3	≈ 3	Ag		●
1660.0203	230			●							6.3	≈ 3	Ag		
1660.3202	230			●							6.3 / 2 x 4.8	≈ 3	Ag	external lamp connection	●
1660.0222	110							●			6.3	≈ 3	Ag		
1661.0201				●							6.3	≈ 3	Ag		●
1661.0220					●		●	●			6.3	≈ 3	Ag		

ROCKER SWITCHES

PUSHBUTTON SWITCHES

TOGGLE SWITCHES

SLIDE SWITCHES

ROTARY SWITCHES

FOOT SWITCHES

POWER TOOL SWITCHES

TACT AND KEY SWITCHES



















SNAP-ACTION SWITCHES

MICRO-SIGNAL SWITCHES

SENSORS

SERIES 1660 - SINGLE AND DOUBLE-POLE PUSHBUTTON SWITCHES

TO 16 (4) A 250 V AC

 double-pole		Voltage lamp in V	Actuator color / printing	Housing color	16 (4) A 250 V AC 1E4	16 (4) A 250 V AC	12 (4) A 250 V AC 1E4	12 A 250 V AC 1/2 HP	12 A 125 V AC 1/6 HP	Connection type	Connection description	Contact distance in mm	Contact material	Miscellaneous	Stock version
Normally open contact (SPNO)															
1661.0101					●						6.3	≥ 3	Ag		●
Switch (SPDT)															
1663.0201							●				4.8	< 3	Ag		●
Changeover switch (SPDT momentary)															
1663.0101							●				4.8	< 3	Ag		●
Lamp															
Lamp															
1667.0101	230										6.3				●
1667.0102	230										6.3				●
1667.0104	230										6.3				●

ROCKER SWITCHES
 PUSHBUTTON SWITCHES
 TOGGLE SWITCHES
 SLIDE SWITCHES
 ROTARY SWITCHES
 FOOT SWITCHES
 POWER TOOL SWITCHES
 TACT AND KEY SWITCHES
 SNAP-ACTION SWITCHES
 MICRO-SIGNAL SWITCHES
 SENSORS

SERIES 1660 - SINGLE AND DOUBLE-POLE PUSHBUTTON SWITCHES

TO 16 (4) A 250 V AC



Basic types 1660, 1661, 1662, 1663 and 1665
double-pole
illuminated / non-illuminated

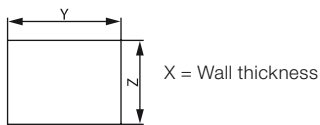

X	Y	Z
0.75 ... 1.0	30 ^{+0.1}	22.2 ^{+0.2}
1.0 ... 1.5	30.2 ^{+0.1}	22.2 ^{+0.2}
1.5 ... 3.0	30.4 ^{+0.1}	22.2 ^{+0.2}

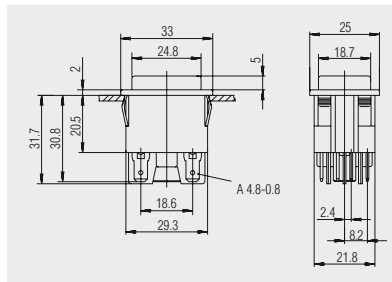

Quick-connect terminal 4.8

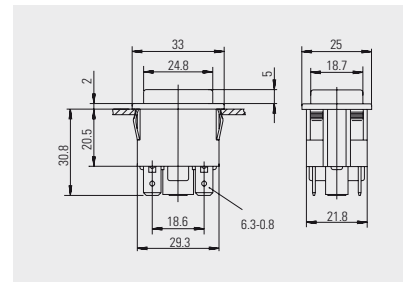

Quick-connect terminal 6.3

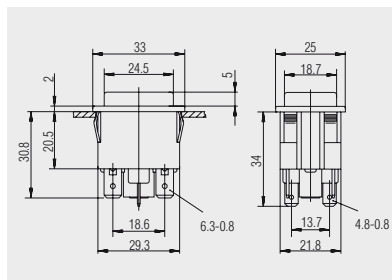

Quick-connect terminal 6.3 / 2 x 4.8
with external lamp connection



Basic type 1667
Lamp

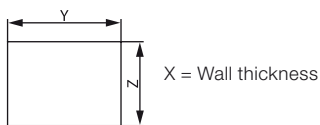

X	Y	Z
0.75 ... 1.0	30 ^{+0.1}	22.2 ^{+0.2}
1.0 ... 1.5	30.2 ^{+0.1}	22.2 ^{+0.2}
1.5 ... 3.0	30.4 ^{+0.1}	22.2 ^{+0.2}

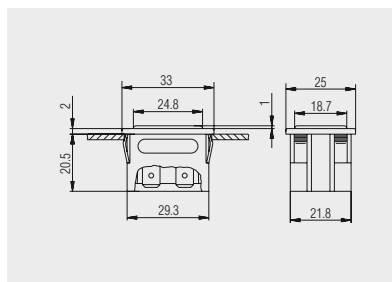

Quick-connect terminal 6.3



Gasket
340.040.011

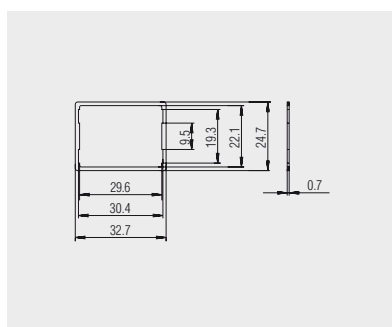

Gasket of EPDM black for sealing
between switch and appliance for
increased dust and water protection

ROCKER SWITCHES

PUSHBUTTON SWITCHES

TOGGLE SWITCHES

SLIDE SWITCHES

ROTARY SWITCHES

FOOT SWITCHES

POWER TOOL SWITCHES

TACT AND KEY SWITCHES

SNAP-ACTION SWITCHES

MICRO-SIGNAL SWITCHES

SENSORS

SERIES 1660 - SINGLE AND DOUBLE-POLE PUSHBUTTON SWITCHES

TO 16 (4) A 250 V AC

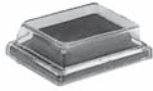

Protection cap
203.201.011

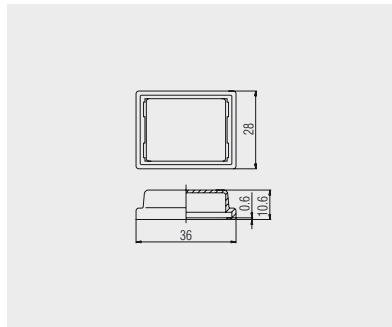

Transparent PVC-protection cap for switches of the basic types 1660, 1662, 1663, 1664, 1665 and 1667. Serves as dust and water protection of the actuation side.



Window
203.107.011 - orange
203.107.031 - green

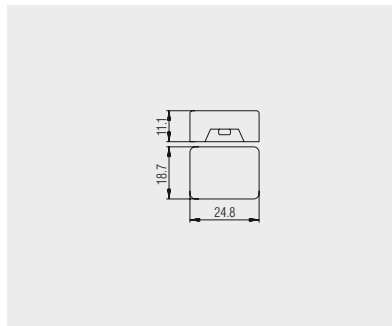

Transparent window for assembly by customer. Switches and lamps without mounted cap are available on request.



Dummy piece
203.028.013

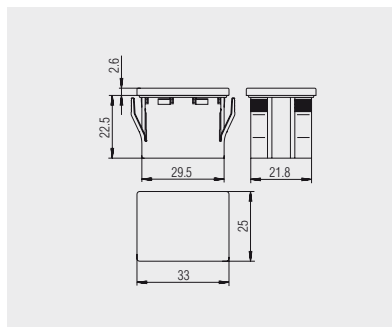

Dummy piece for size of basic type 1667 of PA with housing and cover in black and with mounted gasket (340.040.011) for dust and water protection

ROCKER SWITCHES

PUSHBUTTON SWITCHES

TOGGLE SWITCHES

SLIDE SWITCHES

ROTARY SWITCHES

FOOT SWITCHES

POWER TOOL SWITCHES

TACT AND KEY SWITCHES

SNAP-ACTION SWITCHES

MICRO-SIGNAL SWITCHES

SENSORS