

# SERIES 1683 - SINGLE AND DOUBLE-POLE PUSHBUTTON SWITCHES

TO 16 A 250 V AC

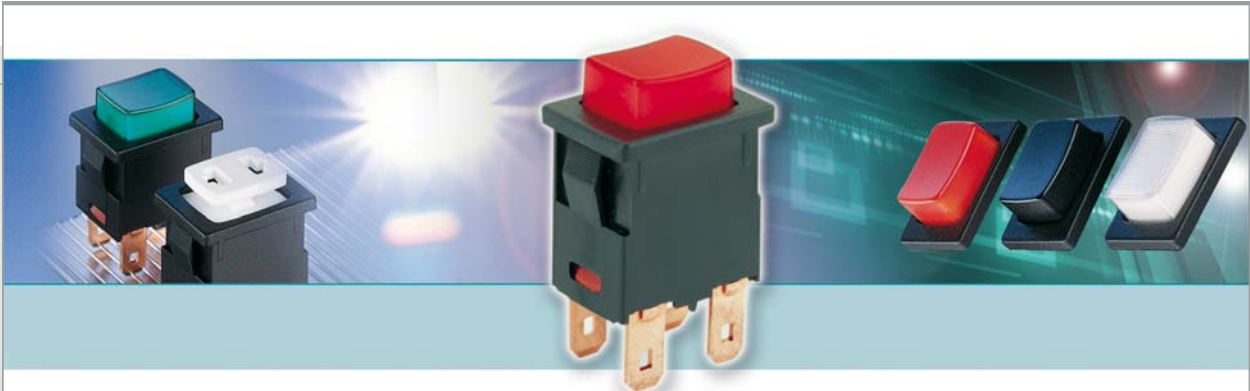



## PRODUCT FEATURES

- ◆ Million times proven, double lifting contact system
- ◆ High electrical rating up to 16 A
- ◆ High rating with 100 000 mechanical switching cycles
- ◆ Illuminated and non-illuminated variants

## ON REQUEST



















- ◆ Other colors
- ◆ Printing
- ◆ Other lamp variants
- ◆ Snap-on customized actuators
- ◆ Other connection variants (e.g. 6.3 x 0.8 mm)
- ◆ Cable assembly
- ◆ Variant with dust and water protection

Mechanical life endurance	10E4
Operating force	ca. 12 N ca. 8 N (basic type 1683)
Contact resistance (new condition)	< 100 mOhm (1 A 12 V DC)
Insulation resistance (new condition)	> 100 MOhm (500 V DC)
Voltage strength at 250 V	1 500 V function insulation / basic insulation 3 000 V reinforced insulation 500 V small contact distance
Proof tracking	250 PTI
Insulation spacing	acc. to EN 61058 for reinforced or double insulation
Ambient temperature	connection side -20 °C ... +100 °C actuating side -20 °C ... +55 °C
Flammability	UL 94 (actuator: V-0, socket: V-1, housing: V-2)
Heat and fire resistance	850 °C (category D)
Material	actuator: PC housing: PA / PA glass fiber-reinforced connections: silver-plated
Plug force of the terminals	≤ 80 N
Approval marks	 /  / 
Suitable for appliances of protection class II	



# SERIES 1683 - SINGLE AND DOUBLE-POLE PUSHBUTTON SWITCHES

TO 16 A 250 V AC

 single-pole		Voltage lamp in V	Actuator color / printing	16 (4) A 250 V AC 1E4	12 (8) A 250 V AC 1E4	10 (8) A 250 V AC 5E4	12 A 125 - 250 V AC 1/2 HP	Connection type	Connection description	Contact distance mm	Contact material	Free position (FP) max. in mm	Operating position (OP) in mm	Permissible total travel position (TP) in mm	Miscellaneous	Actuator description	Stock version
<b>ON/OFF switch (SPST)</b>																	
1686.1101	230		● ● ● ●	● ● ● ●	● ● ● ●	● ● ● ●	⊥	4.8	≈ 3	Ag	23.9	20.85	19.7			●	
1686.1304	230		● ● ● ●	● ● ● ●	● ● ● ●	● ● ● ●	⊥	4.8	≈ 3	Ag	23.9	20.85	19.7				
1683.1101			● ● ● ●	● ● ● ●	● ● ● ●	● ● ● ●	⊥	4.8	≈ 3	Ag	23.9	20.85	19.7				
1683.1701			● ● ● ●	● ● ● ●	● ● ● ●	● ● ● ●	⊥	4.8	≈ 3	Ag	23.5	20.45	19.3	snap-on actuator			
1683.1801			● ● ● ●	● ● ● ●	● ● ● ●	● ● ● ●	⊥	4.8	≈ 3	Ag	23.5	20.45	19.3				
1683.3101			● ● ● ●	● ● ● ●	● ● ● ●	● ● ● ●	⊥	4.8 horizontal	≈ 3	Ag	23.5	20.45	19.3				
<b>Normally open contact (SPNO)</b>																	
1683.1201			● ● ● ●	● ● ● ●	● ● ● ●	● ● ● ●	⊥	4.8	≈ 3	Ag	23.9	20.85	19.7			●	
1683.1802			● ● ● ●	● ● ● ●	● ● ● ●	● ● ● ●	⊥	4.8	≈ 3	Ag	23.5	20.45	19.3				
1683.3601			● ● ● ●	● ● ● ●	● ● ● ●	● ● ● ●	⊥	4.8 horizontal	≈ 3	Ag	23.5	20.45	19.3	snap-on actuator			
<b>double-pole</b>																	
 double-pole		Voltage lamp in V	Actuator color / printing	16 (4) A 250 V AC 1E4	12 (8) A 250 V AC 1E4	10 (8) A 250 V AC 5E4	12 A 125 - 250 V AC 1/2 HP	Connection type	Connection description	Contact distance mm	Contact material	Free position (FP) max. in mm	Operating position (OP) in mm	Permissible total travel position (TP) in mm	Miscellaneous	Actuator description	Stock version
<b>ON/OFF switch (DPST)</b>																	
1687.1104	230		● ● ● ●	● ● ● ●	● ● ● ●	● ● ● ●	⊥	4.8	≈ 3	Ag	23.9	20.85	19.7			●	
1684.1101			● ● ● ●	● ● ● ●	● ● ● ●	● ● ● ●	⊥	4.8	≈ 3	Ag	23.9	20.85	19.7			●	
1684.1104			● ● ● ●	● ● ● ●	● ● ● ●	● ● ● ●	⊥	4.8	≈ 3	Ag	23.9	20.85	19.7				
1684.1701			● ● ● ●	● ● ● ●	● ● ● ●	● ● ● ●	⊥	4.8	≈ 3	Ag	23.5	20.45	19.3	snap-on actuator			
1684.1801			● ● ● ●	● ● ● ●	● ● ● ●	● ● ● ●	⊥	4.8	≈ 3	Ag	23.5	20.45	19.3				
1684.2701			● ● ● ●	● ● ● ●	● ● ● ●	● ● ● ●	⊥	vertical	≈ 3	Ag	23.5	20.45	19.3	snap-on actuator			
<b>Normally open contact (DPNO)</b>																	
1684.1201			● ● ● ●	● ● ● ●	● ● ● ●	● ● ● ●	⊥	4.8	≈ 3	Ag	23.9	20.85	19.7			●	
1684.1802			● ● ● ●	● ● ● ●	● ● ● ●	● ● ● ●	⊥	4.8	≈ 3	Ag	23.5	≤ 20.45	19.3				

ROCKERS SWITCHES  
 PUSHBUTTON SWITCHES  
 TOGGLE SWITCHES  
 SLIDE SWITCHES  
 ROTARY SWITCHES  
 FOOT SWITCHES  
 POWER TOOL SWITCHES  
 TACT AND KEY SWITCHES  
 SNAP-ACTION SWITCHES  
 MICRO-SIGNAL SWITCHES  
 SENSORS

# SERIES 1683 - SINGLE AND DOUBLE-POLE PUSHBUTTON SWITCHES

TO 16 A 250 V AC



Basic type 1683  
single-pole  
non-illuminated

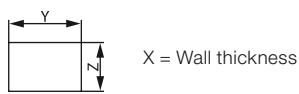

X	Y	Z
0.75 ... 1.25	19.2 <sup>-0.1</sup>	12.9 <sup>+0.1</sup>
1.25 ... 2	19.4 <sup>-0.1</sup>	12.9 <sup>+0.1</sup>
2 ... 3	19.8 <sup>-0.1</sup>	12.9 <sup>+0.1</sup>

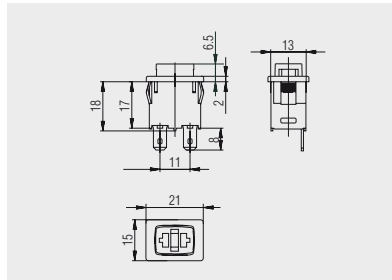

Quick-connect terminal 4.8

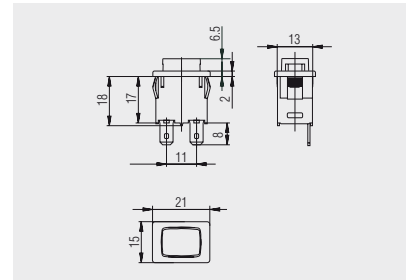

Quick-connect terminal 4.8

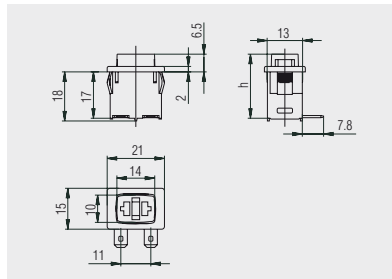

Quick-connect terminal 4.8  
horizontal

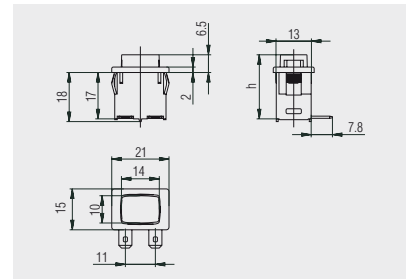

Quick-connect terminal 4.8  
horizontal



Basic types 1684,1686 and 1687  
single and double-pole  
illuminated / non-illuminated

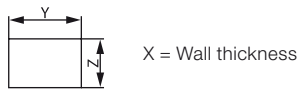

X	Y	Z
0.75 ... 1.25	19.2 <sup>-0.1</sup>	12.9 <sup>+0.1</sup>
1.25 ... 2	19.4 <sup>-0.1</sup>	12.9 <sup>+0.1</sup>
2 ... 3	19.8 <sup>-0.1</sup>	12.9 <sup>+0.1</sup>

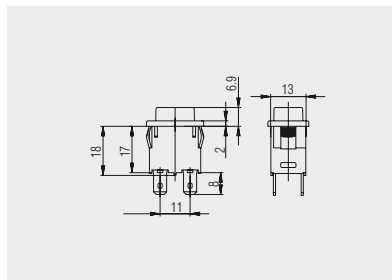

Quick-connect terminal 4.8  
1684.1101, 1684.1104, 1684.1201,  
basic types 1687 and 1686

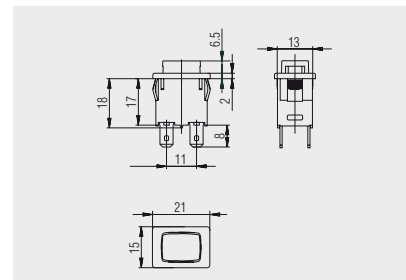

Quick-connect terminal 4.8  
basic type 1684

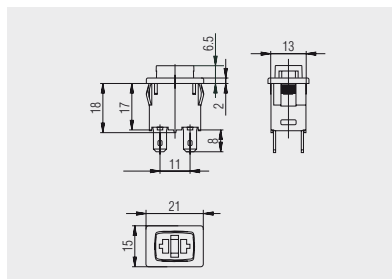

Quick-connect terminal 4.8  
basic type 1684

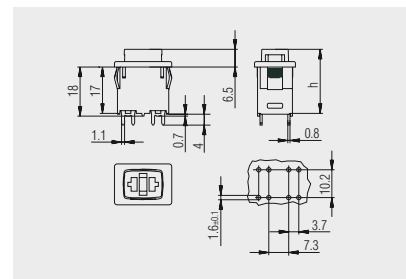

PCB terminal vertical  
1684.2701



Protection cap  
203.701.011

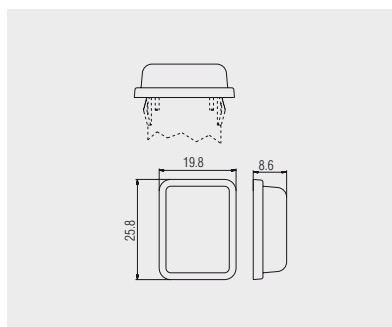

Transparent PVC-protection cap for  
dust and water protection from the  
actuation side

ROCKER SWITCHES

PUSHBUTTON SWITCHES

TOGGLE SWITCHES

SLIDE SWITCHES

ROTARY SWITCHES

FOOT SWITCHES

POWER TOOL SWITCHES

TACT AND KEY SWITCHES

SNAP-ACTION SWITCHES

MICRO-SIGNAL SWITCHES

SENSORS