

SERIES 1840 - SINGLE AND DOUBLE-POLE PUSHBUTTON SWITCHES

TO 6 (4) A 250 V AC



PRODUCT FEATURES

- ◆ 100 million times proven switching principle with longer life endurance with 100 000 mechanical switching cycles
- ◆ Fastening by round nut M12
- ◆ Excellent actuating characteristic
- ◆ Variant for snapping on customized pushbuttons

ON REQUEST

- ◆ Higher power with 6 (6) A 250 V AC
- ◆ Other connection types
- ◆ Cable assembly

Mechanical life endurance	10E4
Contact resistance (new condition)	< 100 mOhm (1 A 12 V DC)
Insulation resistance (new condition)	> 100 MOhm (500 V DC)
Voltage strength at 250 V	1 500 V function insulation / basic insulation 3 000 V reinforced insulation 500 V small contact distance
Proof tracking	250 PTI
Insulation spacing	acc. to EN 61058 for reinforced or double insulation
Protection type	IP 40
Ambient temperature	connection side -20 °C ... +100 °C actuating side -20 °C ... +55 °C
Flammability	UL 94 V-2
Heat and fire resistance	850 °C (category D)
Material	actuator PA housing PA glass fiber-reinforced / PA connections silver-plated
Plug force of the terminals	≤ 80 N
Approval marks	
Suitable for appliances of protection class II	



ROCKER SWITCHES

PUSHBUTTON SWITCHES

TOGGLE SWITCHES

SLIDE SWITCHES

ROTARY SWITCHES

FOOT SWITCHES

POWER TOOL SWITCHES

TACT AND KEY SWITCHES



























SNAP-ACTION SWITCHES

MICRO-SIGNAL SWITCHES

SENSORS

SERIES 1840 - SINGLE AND DOUBLE-POLE PUSHBUTTON SWITCHES

TO 6 (4) A 250 V AC

 single-pole	Actuator color / printing	Housing color	6 (4) A 250 V AC 5E4	6 (2) A 250 V AC 5E4	6 A 250 V AC 1/2 HP	6 A 125 V AC 1/4 HP	6 A 125 - 250 V AC 1/8 HP	Connection type	Connection description	Contact distance in mm	Contact material	Miscellaneous	Stock version
ON/OFF switch (SPST)													
1841.1101			●		●	●			4.8	≥ 3	Ag		●
1841.6101			●		●	●			4.8	≥ 3	Ag	snap-on actuator (caps see page 112)	●
Normally closed contact (SPNC)													
1841.1301				●			●		4.8	≥ 3	Ag		●
Normally open contact (SPNO)													
1841.1201				●			●		4.8	≥ 3	Ag		●
Switch (SPDT)													
1843.1101			●		●	●			4.8	≥ 3	Ag		●
Changeover switch (SPDT momentary)													
1843.1201				●			●		4.8	≥ 3	Ag		●
 double-pole	Actuator color / printing	Housing color	6 (4) A 250 V AC 5E4	6 (2) A 250 V AC 5E4	6 A 250 V AC 1/2 HP	6 A 125 V AC 1/4 HP	6 A 125 - 250 V AC 1/8 HP	Connection type	Connection description	Contact distance in mm	Contact material	Miscellaneous	Stock version
ON/OFF switch (DPST)													
1842.1101			●		●	●			4.8	≥ 3	Ag		●
1842.6101			●		●	●			4.8	≥ 3	Ag	snap-on actuator (caps see page 112)	●

ROCKER SWITCHES

PUSHBUTTON SWITCHES

TOGGLE SWITCHES

SLIDE SWITCHES

ROTARY SWITCHES

FOOT SWITCHES

POWER TOOL SWITCHES

TACT AND KEY SWITCHES

SNAP-ACTION SWITCHES

MICRO-SIGNAL SWITCHES

SENSORS

SERIES 1840 - SINGLE AND DOUBLE-POLE PUSHBUTTON SWITCHES

TO 6 (4) A 250 V AC



Basic types 1841 and 1843
single-pole

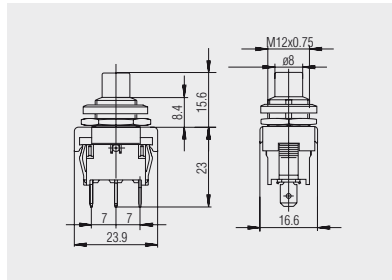

Quick-connect terminal 4.8



Basic type 1842
double-pole

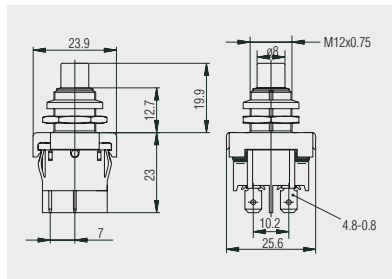

Quick-connect terminal 4.8



Identification plate
240.001.011



Identification plate of aluminum for plugging on with black inscription "ON" and "OFF"



Identification plate
240.002.011

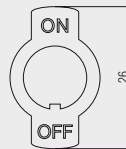

Identification plate of CuZn nickel-plated for plugging on as well as with twist protection and stamped inscription "ON" and "OFF"



Protection cap
343.002.023

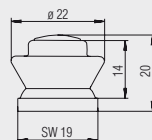

Neopren® - cap for pushbutton (M12 x 0.75) basic type 1840 as dust and water protection. Pushbutton plate on top of cap is CuZn nickel-plated.

ROCKER SWITCHES

PUSHBUTTON SWITCHES

TOGGLE SWITCHES

SLIDE SWITCHES

ROTARY SWITCHES

FOOT SWITCHES

POWER TOOL SWITCHES

TACT AND KEY SWITCHES

SNAP-ACTION SWITCHES

MICRO-SIGNAL SWITCHES

SENSORS

SERIES 1840 - SINGLE AND DOUBLE-POLE PUSHBUTTON SWITCHES

TO 6 (4) A 250 V AC

ROCKER SWITCHES

PUSHBUTTON SWITCHES

TOGGLE SWITCHES

SLIDE SWITCHES

ROTARY SWITCHES

FOOT SWITCHES

POWER TOOL SWITCHES

TACT AND KEY SWITCHES

SNAP-ACTION SWITCHES

MICRO-SIGNAL SWITCHES

SENSORS



Pushbutton
205.008.011

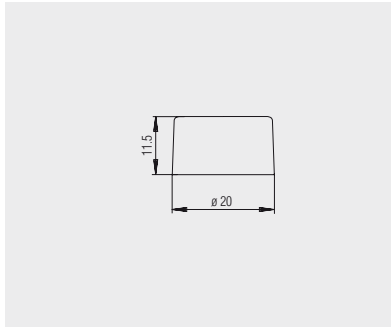

Pushbutton of PA black, with diameter 20 mm for assembly by customer on 1841.6101 and 1842.6101



Pushbutton
203.106.011

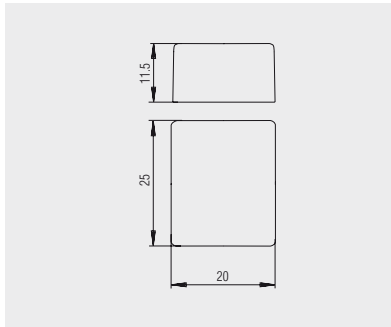

Pushbutton of PA black, rectangular 20 x 25 mm for assembly by customer on 1841.6101 and 1842.6101

Further information under

WWW.MARQUARDT.DE