

SERIES 1855 - SMALLEST DOUBLE-POLE ROCKER SWITCHES

TO 4 (1) A 250 V AC

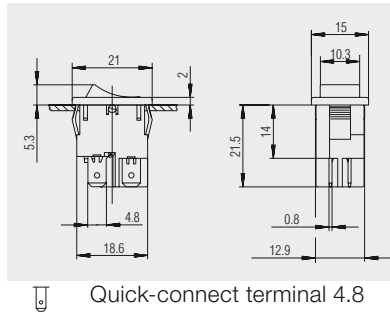

Basic type 1855



Quick-connect terminal 4.8

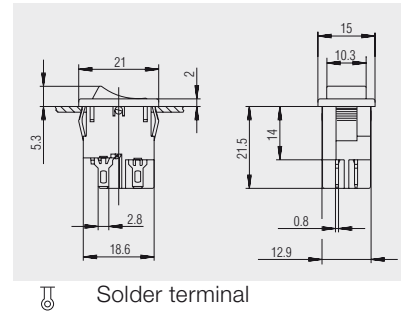

Solder terminal

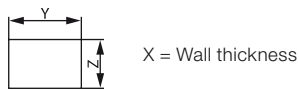

X	Y	Z
0.75 ... 1.25	19.2 ^{-0.1}	12.9 ^{+0.1}
1.25 ... 2	19.4 ^{-0.1}	12.9 ^{+0.1}
2 ... 3	19.8 ^{-0.1}	12.9 ^{+0.1}



Protection cap
203.089.011

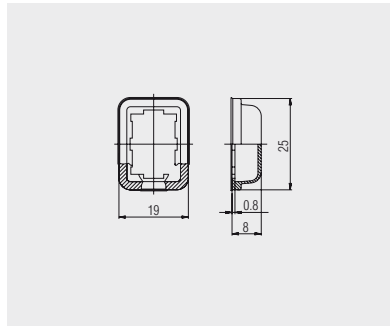

Transparent PVC-protection cap.
Serves as dust and water protection
for the actuating side.

ROCKER SWITCHES

PUSHBUTTON SWITCHES

TOGGLE SWITCHES

SLIDE SWITCHES

ROTARY SWITCHES

FOOT SWITCHES

POWER TOOL SWITCHES

TACT AND KEY SWITCHES

SNAP-ACTION SWITCHES

MICRO-SIGNAL SWITCHES

SENSORS

SERIES 1858 - SMALLEST DOUBLE-POLE ROCKER SWITCHES

TO 12 (4) A 250 V AC





PRODUCT FEATURES

- ◆ Non-illuminated rocker switch
- ◆ Powerful with inrush currents (capacitive) up to 100 A
- ◆ Immediately self-extinguishing due to UL 94 V-0 material
- ◆ Conformant acc. to EN 60065 par. 14.6

ON REQUEST



























- ◆ Other colors
- ◆ Other printing variants
- ◆ Single-pole assembled
- ◆ Cable assembly

Mechanical life endurance	10E4
Operating force	≤ 5 N
Inrush current (capacitive)	100 A
Contact resistance (new condition)	< 100 mOhm (1 A 12 V DC)
Insulation resistance (new condition)	> 100 MOhm (500 V DC)
Voltage strength at 250 V	1 500 V function insulation / basic insulation 3 000 V reinforced insulation 500 V small contact distance
Proof tracking	250 PTI
Insulation spacing	acc. to EN 61058 for reinforced or double insulation
Protection type	IP 40
Ambient temperature	connection side -20 °C ... +100 °C actuating side -20 °C ... +55 °C
Flammability	UL 94 V-0 UL 94 V-2 (in the versions in white)
Heat and fire resistance	850 °C (category D)
Material	actuator PA housing PA connections silver-plated
Plug force of the terminals	≤ 80 N
Approval marks	 /  / 
Suitable for appliances of protection class II	



SERIES 1858 - SMALLEST DOUBLE-POLE ROCKER SWITCHES

TO 12 (4) A 250 V AC

	Actuator color / printing	Housing color	10 (4) A 250 V AC 1E4	6 (4) A 250 V AC 5E4	12 A 250 V AC 1/2 HP	12 A 125 V AC 1/3 HP	Connection type	Connection description	Contact distance in mm	Contact material	EN 60335 cap. 30 conform "G"	Miscellaneous	Stock version
ON/OFF switch (DPST)													
1858.0103			●	●	●	●			≥ 3	Ag	●		●
1858.0104			●	●	●	●			≥ 3	Ag	●		●
1858.1102			●	●	●	●		4.8	≥ 3	Ag	●		●
1858.1103			●	●	●	●		4.8	≥ 3	Ag	●		●
1858.1104			●	●	●	●		4.8	≥ 3	Ag	●		●
1858.1105			●	●	●	●		4.8	≥ 3	Ag		connection spacing 10	
1858.2202			●	●	●	●			≥ 3	Ag	●		●
1858.2204			●	●	●	●			≥ 3	Ag	●		●
1858.4202			●	●	●	●			≥ 3	Ag	●		●
1858.4205			●	●	●	●			≥ 3	Ag	●		●
1858.5104			●	●	●	●			≥ 3	Ag	●	single-pole occupied	
1858.7204			●	●	●	●			≥ 3	Ag	●	single-pole occupied	
1858.9202			●	●	●	●			≥ 3	Ag	●	single-pole occupied	

Further information under

WWW.MARQUARDT.DE

ROCKER SWITCHES

PUSHBUTTON SWITCHES

TOGGLE SWITCHES

SLIDE SWITCHES

ROTARY SWITCHES

FOOT SWITCHES

POWER TOOL SWITCHES

TACT AND KEY SWITCHES

SNAP-ACTION SWITCHES

MICRO-SIGNAL SWITCHES

SENSORS

SERIES 1858 - SMALLEST DOUBLE-POLE ROCKER SWITCHES

T0 12 (4) A 250 V AC



Basic type 1858 double-pole

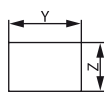

X = Wall thickness

X	Y	Z
0.75 ... 1.25	19.2 ^{-0.1}	12.9 ^{+0.1}
1.25 ... 2	19.4 ^{-0.1}	12.9 ^{+0.1}
2 ... 3	19.8 ^{-0.1}	12.9 ^{+0.1}

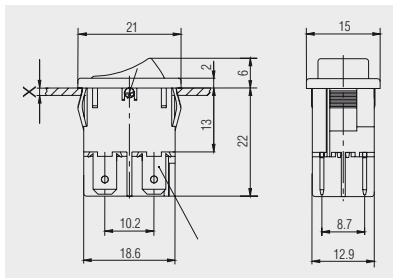

Quick-connect terminal 4.8

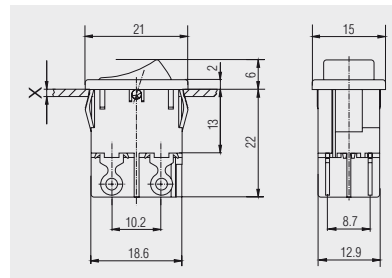

Solder terminal

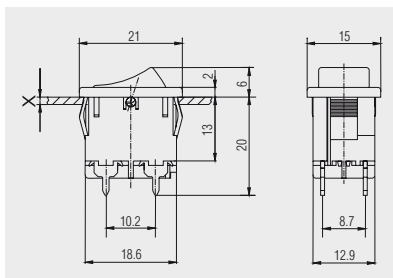

PCB terminal

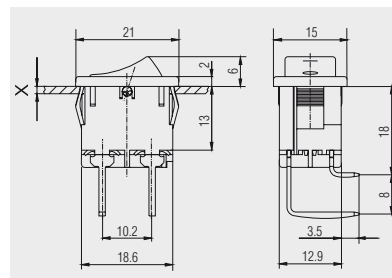

PCB terminal angled to terminal side 1

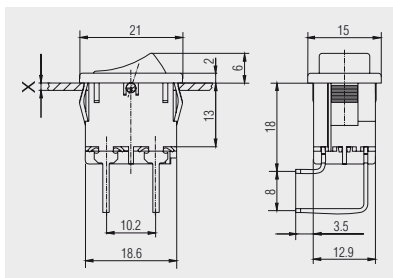

PCB terminal angled to terminal side 2



Protection cap 203.089.011

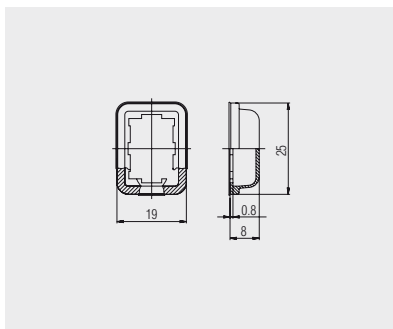

Transparent PVC-protection cap. Serves as dust and water protection of the actuation side.