



**Changeoverswitches, TM, 10 A, centre mounting, 1 contact unit(s),  
Contacts: 2, 60 °, maintained, With 0 (Off) position, HAND-0-AUTO, design  
no. 15431**



**Part no. TM-1-15431/EZ**  
**Catalog No. 000691**

**EL-Nummer 0001456163**  
**(Norway)**

Similar to illustration

## Delivery program

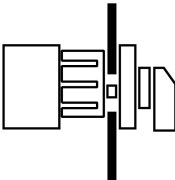
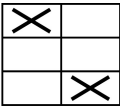
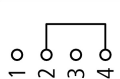
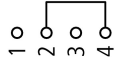
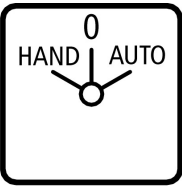
Product range			Control switches
Part group reference			TM
Basic function			Changeoverswitches with black thumb grip and front plate
Contacts			2
Degree of Protection			Front IP65
Design			centre mounting
			
Contact sequence			AUTO  0 HAND  
Switching angle		°	60
Switching performance			maintained With 0 (Off) position
Design number			15431
Front plate no.			 <b>F 085</b>
front plate			HAND-0-AUTO
<b>Motor rating AC-23A, 50 - 60 Hz</b>			
400 V	P	kW	3
Rated uninterrupted current	I <sub>u</sub>	A	10
Note on rated uninterrupted current I <sub>u</sub>			Rated uninterrupted current I <sub>u</sub> is specified for max. cross-section.
Number of contact units		contact unit(s)	1

## Technical data

<b>General</b>			
Standards			IEC/EN 60947, VDE 0660, CSA, UL Control switch as per IEC/EN 60947-5-1 Auxiliary switch as per IEC/EN 60947-5-1
Climatic proofing			Damp heat, constant, to IEC 60068-2-78 Damp heat, cyclic, to IEC 60068-2-30

Ambient temperature			
Open		°C	-25 - +50
Overvoltage category/pollution degree			III/3
Rated impulse withstand voltage	$U_{imp}$	V AC	4000
Mounting position			As required

## Contacts

Electrical characteristics			
Rated operational voltage	$U_e$	V AC	500
Rated uninterrupted current	$I_u$	A	10
Note on rated uninterrupted current $I_u$			Rated uninterrupted current $I_u$ is specified for max. cross-section.
Short-circuit rating			
Fuse		A gG/gL	10

## Switching capacity

Safe isolation to EN 61140			
Current heat loss per contact at $I_e$		W	0.15
Current heat loss per auxiliary circuit at $I_e$ (AC-15/230 V)		CO	0.15
Lifespan, mechanical	Operations	$\times 10^6$	> 1
Maximum operating frequency	Operations/h		1200
AC			
AC-21A			
Rated operational current switch			
400 V 415 V	$I_e$	A	10
AC-23A			
Motor rating AC-23A, 50 - 60 Hz	P	kW	
400 V 415 V	P	kW	3
Control circuit reliability at 24 V DC, 10 mA	Fault probability	$H_F$	$< 10^{-5}$ , < 1 failure in 100,000 switching operations

## Terminal capacities

Solid or stranded		mm <sup>2</sup>	1 x 1,5 2 x 1,5
Flexible with ferrules to DIN 46228		mm <sup>2</sup>	1 x 1.0 2 x 1.0
Flexible		mm <sup>2</sup>	1 x 1.5 2 x 1.5
Terminal screw			M2.5
Tightening torque for terminal screw		Nm	0.4

## Rating data for approved types

Contacts			
Rated operational voltage	$U_e$	V AC	300
Rated uninterrupted current max.			
Main conducting paths			
General use		A	10
Auxiliary contacts			
General Use	$I_u$	A	10
Pilot Duty			A 300
Switching capacity			
Maximum motor rating			
Single-phase			
120 V AC		HP	0.33
240 V AC		HP	0.75
277 V AC		HP	0.75
Three-phase			
120 V AC		HP	0.75
240 V AC		HP	1
Terminal capacity			
Solid or flexible conductor with ferrule		AWG	14
Terminal screw			M2.5

Tightening torque		lb-in	3.5
-------------------	--	-------	-----

## Design verification as per IEC/EN 61439

Technical data for design verification			
Rated operational current for specified heat dissipation	$I_n$	A	10
Heat dissipation per pole, current-dependent	$P_{vid}$	W	0.15
Equipment heat dissipation, current-dependent	$P_{vid}$	W	0
Static heat dissipation, non-current-dependent	$P_{vs}$	W	0
Heat dissipation capacity	$P_{diss}$	W	0
Operating ambient temperature min.		°C	-25
Operating ambient temperature max.		°C	50
IEC/EN 61439 design verification			
10.2 Strength of materials and parts			
10.2.2 Corrosion resistance			
10.2.3.1 Verification of thermal stability of enclosures			
10.2.3.2 Verification of resistance of insulating materials to normal heat			
10.2.3.3 Verification of resistance of insulating materials to abnormal heat and fire due to internal electric effects			
10.2.4 Resistance to ultra-violet (UV) radiation			
10.2.5 Lifting			
10.2.6 Mechanical impact			
10.2.7 Inscriptions			
10.3 Degree of protection of ASSEMBLIES			
10.4 Clearances and creepage distances			
10.5 Protection against electric shock			
10.6 Incorporation of switching devices and components			
10.7 Internal electrical circuits and connections			
10.8 Connections for external conductors			
10.9 Insulation properties			
10.9.2 Power-frequency electric strength			
10.9.3 Impulse withstand voltage			
10.9.4 Testing of enclosures made of insulating material			
10.10 Temperature rise			
10.11 Short-circuit rating			
10.12 Electromagnetic compatibility			
10.13 Mechanical function			

## Technical data ETIM 7.0

Low-voltage industrial components (EG000017) / Control switch (EC002611)			
Electric engineering, automation, process control engineering / Low-voltage switch technology / Off-load switch, circuit breaker, control switch / Control switch (ec1@ss10.0.1-27-37-14-14 [ACN998011])			
Type of switch			Reverser
Number of poles			1
Max. rated operation voltage $U_e$ AC		V	500
Rated permanent current $I_u$		A	10
Number of switch positions			3
With 0 (off) position			Yes
With retraction in 0-position			No
Device construction			Built-in device
Width in number of modular spacings			0
Suitable for ground mounting			No
Suitable for front mounting 4-hole			Yes
Suitable for distribution board installation			No

Suitable for intermediate mounting		No
Complete device in housing		No
Type of control element		Toggle
Front shield size		30x30 mm
Degree of protection (IP), front side		IP65
Degree of protection (NEMA), front side		Other

## Approvals

Product Standards		UL 508; CSA-C22.2 No. 14-05; CSA-C22.2 No. 94; IEC/EN 60947-3; CE marking
UL File No.		E36332
UL Category Control No.		NLRV
CSA File No.		UL report applies to both US and Canada
North America Certification		UL listed, certified by UL for use in Canada
Degree of Protection		IEC: IP65; UL/CSA Type: –

## Dimensions

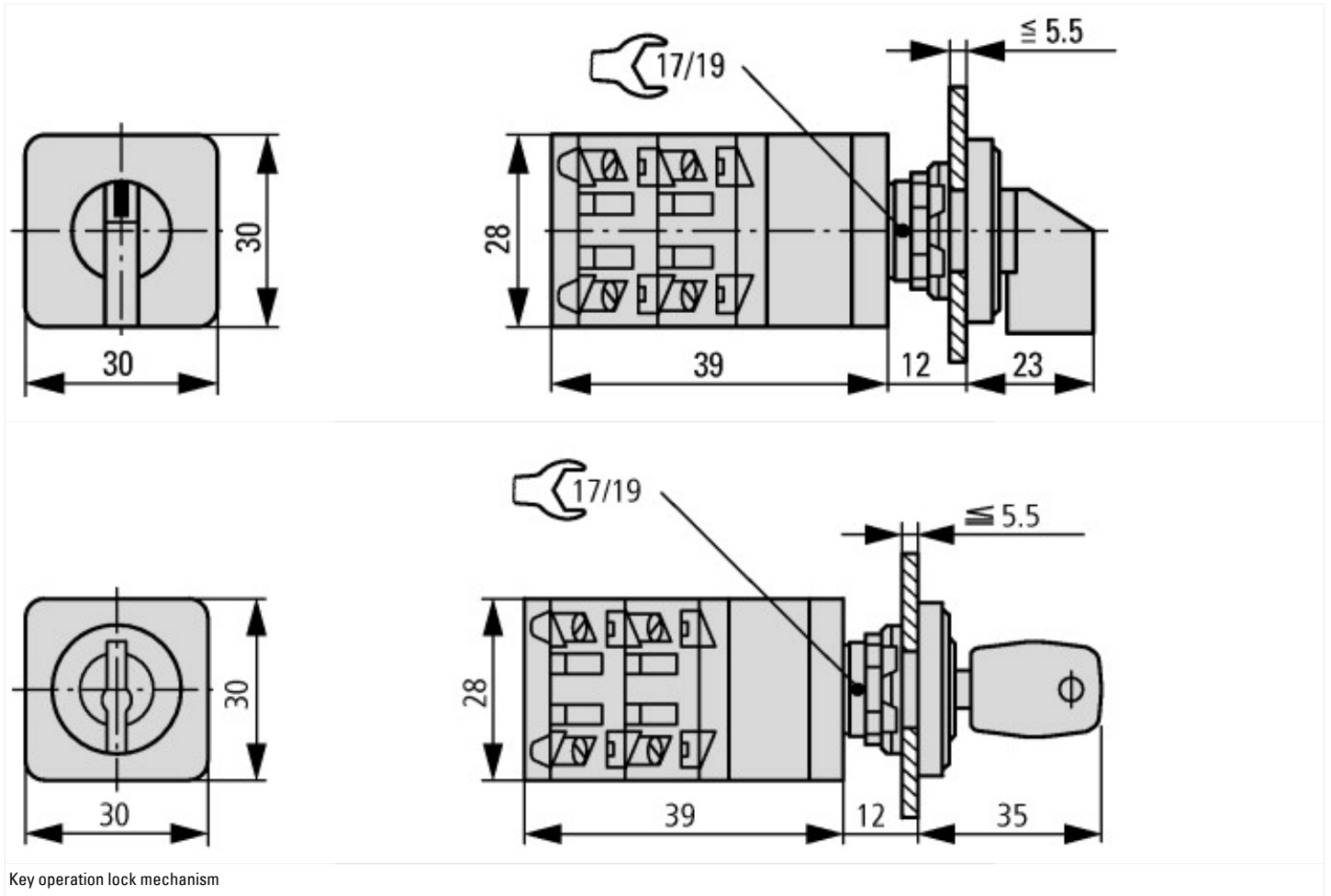

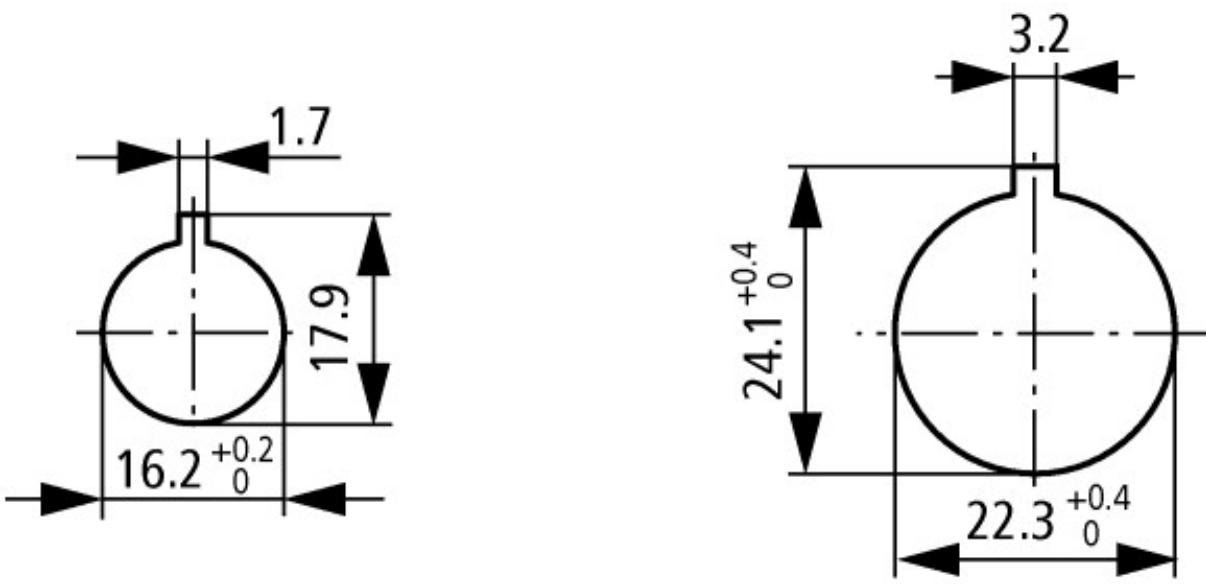

Door drilling dimensions

Drilling dimensions: either 16.2 mm = without reduction  $\triangle$  RMQ16 or 22.3 mm = with reduction  $\triangle$  RMQ Titan