

DIMENSIONS

DS(R)

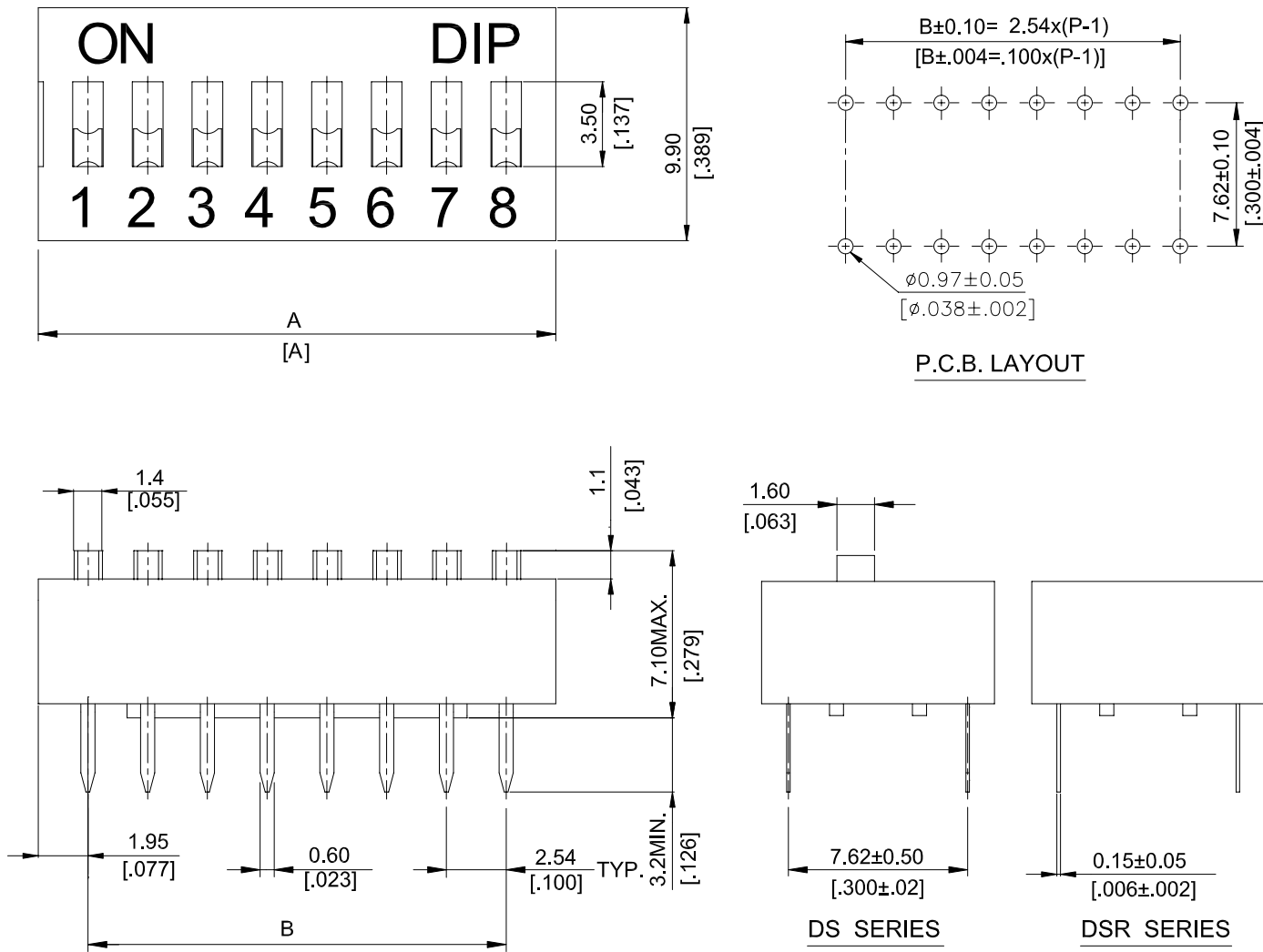

DS -12-V	12	31.84[1.254]	27.94[1.100]
DSR-12-V	12	31.84[1.254]	27.94[1.100]
DS -10-V	10	26.76[1.054]	22.86[.900]
DSR-10-V	10	26.76[1.054]	22.86[.900]
DS -09-V	9	24.22[.954]	20.32[.800]
DSR-09-V	9	24.22[.954]	20.32[.800]
DS -08-V	8	21.68[.854]	17.78[.700]
DSR-08-V	8	21.68[.854]	17.78[.700]
DS -07-V	7	19.14[.754]	15.24[.600]
DSR-07-V	7	19.14[.754]	15.24[.600]
DS -06-V	6	16.60[.654]	12.70[.500]
DSR-06-V	6	16.60[.654]	12.70[.500]
DS -05-V	5	14.06[.554]	10.16[.400]
DSR-05-V	5	14.06[.554]	10.16[.400]
DS -04-V	4	11.52[.454]	7.62[.300]
DSR-04-V	4	11.52[.454]	7.62[.300]
DS -03-V	3	8.98[.354]	5.08[.200]
DSR-03-V	3	8.98[.354]	5.08[.200]
DS -02-V	2	6.44[.254]	2.54[.100]
DSR-02-V	2	6.44[.254]	2.54[.100]
DS -01-V	1	3.90[.153]	-
DSR-01-V	1	3.90[.153]	-
PROD. NO.	NO. OF POS.	DIM. A	DIM. B

SCHEMATIC(TYP.)

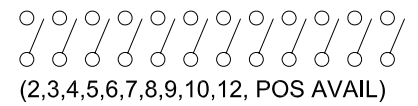

General Tolerance : ±0.2mm

DA

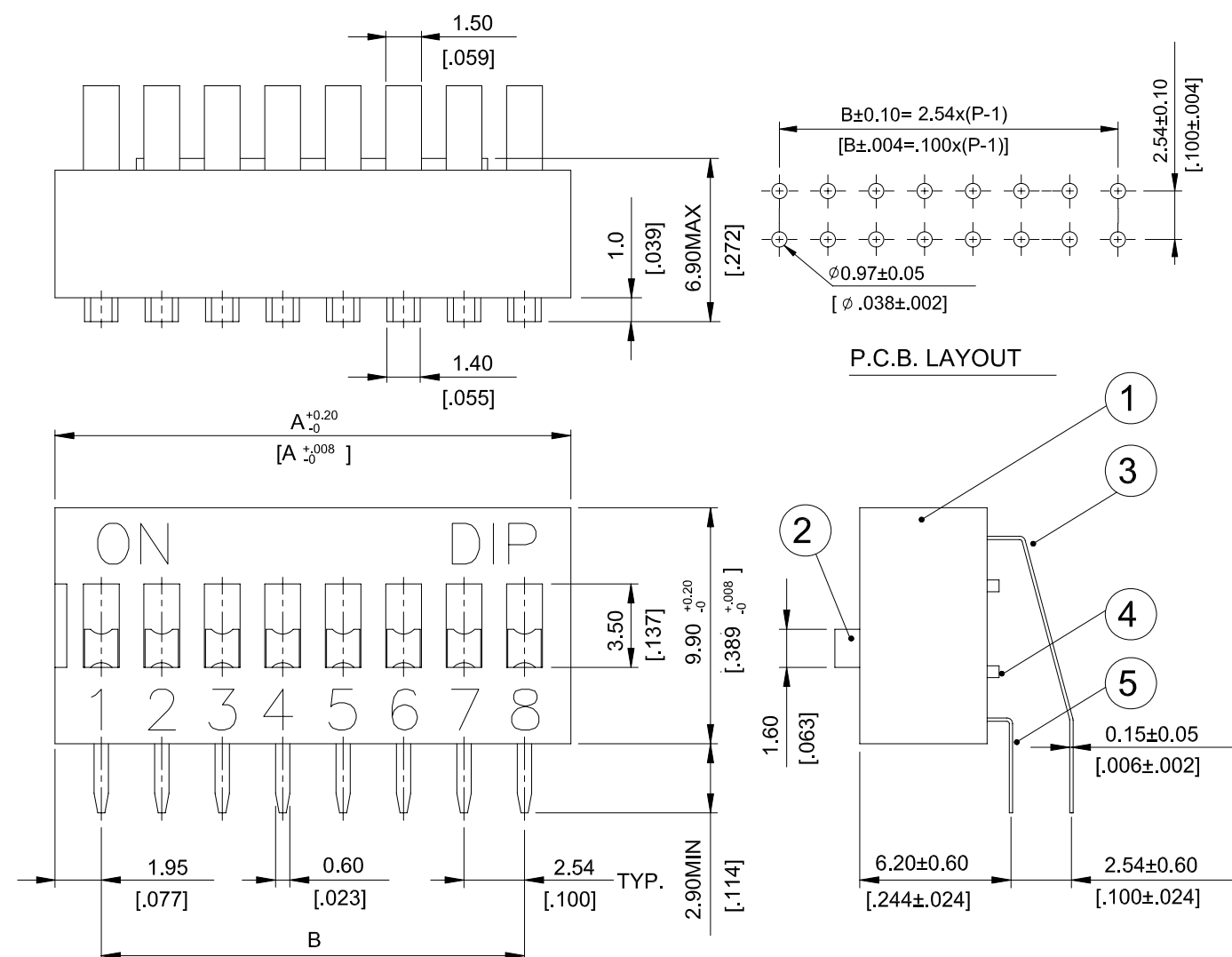

DA-12-V	12	31.84[1.254]	27.94[1.100]
DA-10-V	10	26.76[1.054]	22.86[.900]
DA-09-V	9	24.22[.954]	20.32[.800]
DA-08-V	8	21.68[.854]	17.78[.700]
DA-07-V	7	19.14[.754]	15.24[.600]
DA-06-V	6	16.60[.654]	12.70[.500]
DA-05-V	5	14.06[.554]	10.16[.400]
DA-04-V	4	11.52[.454]	7.62[.300]
DA-03-V	3	8.98[.354]	5.08[.200]
DA-02-V	2	6.44[.254]	2.54[.100]
PROD. NO.	NO. OF POS.	DIM. A	DIM. B

SCHEMATIC(TYP.)

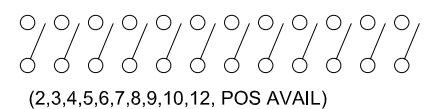

General Tolerance : ±0.2mm

DP(L)

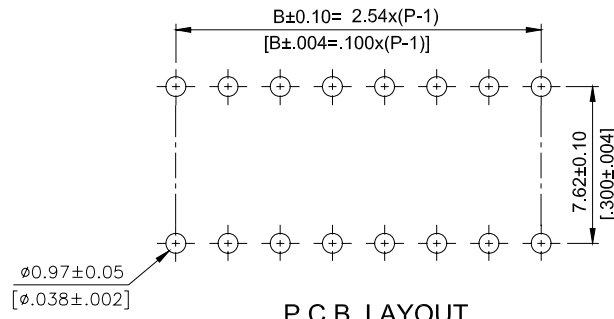
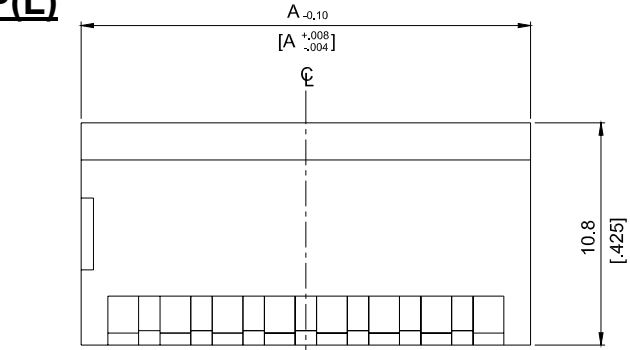

P.C.B. LAYOUT

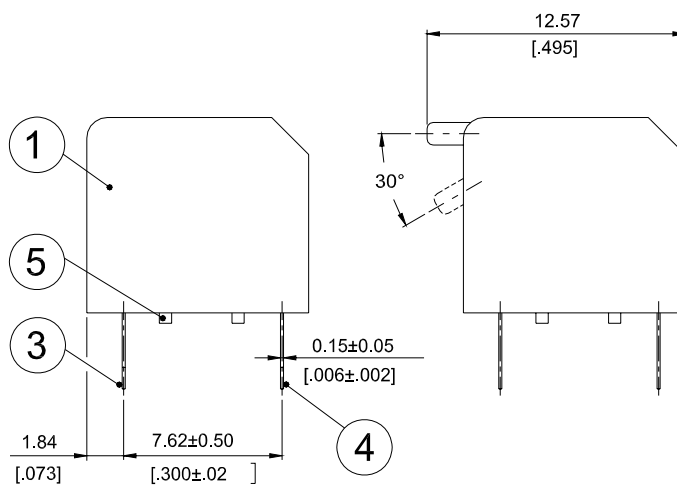
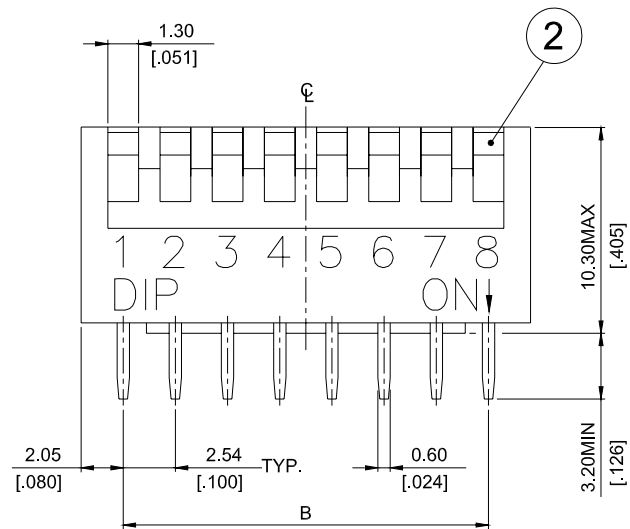

DP SERIES

DPL SERIES

DP -12-V DPL-12 -V	12	32.04[1.261]	27.94[1.100]
DP -10-V DPL-10-V	10	26.96[1.061]	22.86[.900]
DP -09-V DPL-09-V	9	24.42[.961]	20.32[.800]
DP -08-V DPL-08-V	8	21.88[.861]	17.78[.700]
DP -07-V DPL-07-V	7	19.34[.761]	15.24[.600]
DP -06-V DPL-06-V	6	16.80[.661]	12.70[.500]
DP -05-V DPL-05-V	5	14.26[.561]	10.16[.400]
DP -04-V DPL-04-V	4	11.72[.461]	7.62[.300]
DP -03-V DPL-03-V	3	9.18[.361]	5.08[.200]
DP -02-V DPL-02-V	2	6.64[.261]	2.54[.100]
PROD. NO.	NO. OF POS.	DIM. A	DIM. B

SCHEMATIC(TYP.)

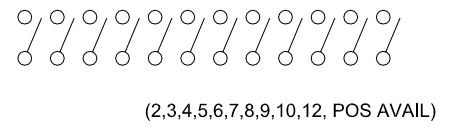

General Tolerance : ±0.2mm

HOW TO ORDER

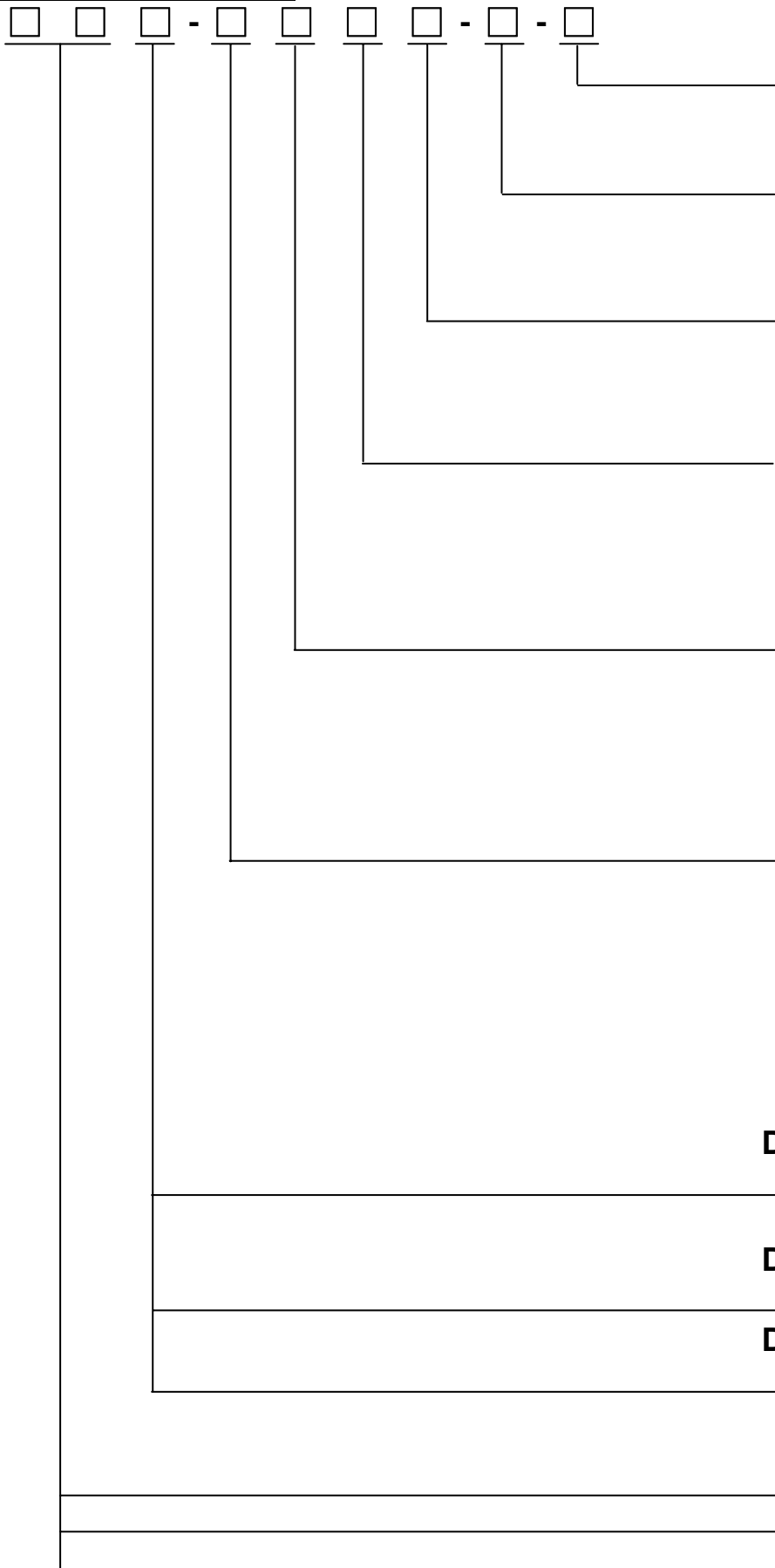

Package :

= Tube

Soldering :

V = Lead Free Solderable

Q=Halogen Free(Only for Black)

Sealed :

= Without Tape

T = Top Tape Sealed

▲ On/Off Position :

= Push Down On

U = Push Down Off

<▲ U Only For DP(L)>

Color Of Cover :

= Red

▲ B = Blue

▲ K = Black

<▲ Subject to Our Final Confirmation>

Number Of Position :

01 = 1 Positions <Only For DS(R)>

02 = 2 Positions 07 = 7 Positions

03 = 3 Positions 08 = 8 Positions

04 = 4 Positions 09 = 9 Positions

05 = 5 Positions 10 = 10 Positions

06 = 6 Positions 12 = 12 Positions

DS

= Raised Actuator

R = Recessed Actuator

DA

= Raised Actuator

DP

= Short Key

L = Long Key

DS = Slide Type Dip Switch

DA = Right Angle Type Dip Switch

DP = Piano Type Dip Switch

SPECIFICATION

△MECHANICAL

Mechanical Life: 2,000 operations per switch.
Operation Force: 400gf max. (DP Series)
1,000gf max. (DS & DA Series)
Stroke: 2.0mm
Operation Temperature: -20°C to +70°C
Storage Temperature: -40°C to +85°C

△ELECTRICAL

Electrical Life: 2,000 operations per switch 24VDC,
25mA
Non-Switching Rating: 100mA , 50VDC
Switching Rating: 25mA , 24VDC
Contact Resistance: 50mΩ max. at initial
Insulation Resistance:{at 500 VDC} 100MΩ min.
Dielectric Strength: 500VAC / 1 minute
Circuit: SPST

MATERIAL

△BASE: UL94V-0 PBT High Thermoplastic

Color: Black

△COVER UL94V-0 PBT High Thermoplastic

Color: Red, Black, Blue

△ACTUATOR: UL94V-0 PBT High Thermoplastic

Color: White

△CONTACT: Phosphor bronze with gold plating over
nickel

△TOP SEAL: Polyester Film

△POTTING MATERIAL: Epoxy

SOLDERING PROCESS

△Keep all switch contacts in their “OFF” position for all operations.

△WAVE SOLDERING: Recommended temperature at 500°F (260°C) max. 5 seconds for through hole type.

△HAND SOLDERING: Use a soldering iron of 30 watts, controlled at 350°C approximately max 5 seconds.

△Make sure switch is in “OFF” position during soldering process, or it will decrease the operating force and meanwhile increase the contact resistance.

△Do not wash the switch body except top tape sealed type, which suitable for spray cleaning method from top of the s/w.

PACKING

Part Number	Number Per Tube	Part Number	Number Per Tube
DS(R)-01	120	DS(R)-01-T	113
DS(R)-02	72	DS(R)-02-T	72
DS(R)-03	51	DS(R)-03-T	51
DS(R)-04	40	DS(R)-04-T	40
DS(R)-05	32	DS(R)-05-T	32
DS(R)-06	27	DS(R)-06-T	27
DS(R)-07	24	DS(R)-07-T	24
DS(R)-08	21	DS(R)-08-T	21
DS(R)-09	19	DS(R)-09-T	19
DS(R)-10	17	DS(R)-10-T	17
DS(R)-12	14	DS(R)-12-T	14
DP(L)-02	70	DP(L)-02-T	65
DP(L)-03	50	DP(L)-03-T	49
DP(L)-04	39	DP(L)-04-T	39
DP(L)-05	32	DP(L)-05-T	32
DP(L)-06	27	DP(L)-06-T	27
DP(L)-07	24	DP(L)-07-T	24
DP(L)-08	21	DP(L)-08-T	21
DP(L)-09	19	DP(L)-09-T	19
DP(L)-10	17	DP(L)-10-T	17
DP(L)-12	14	DP(L)-12-T	14
DA-02	73	DA-02-T	70
DA-03	52	DA-03-T	50
DA-04	40	DA-04-T	39
DA-05	33	DA-05-T	32
DA-06	28	DA-06-T	28
DA-07	24	DA-07-T	24
DA-08	21	DA-08-T	21
DA-09	19	DA-09-T	19
DA-10	17	DA-10-T	17
DA-12	14	DA-12-T	14

DSR

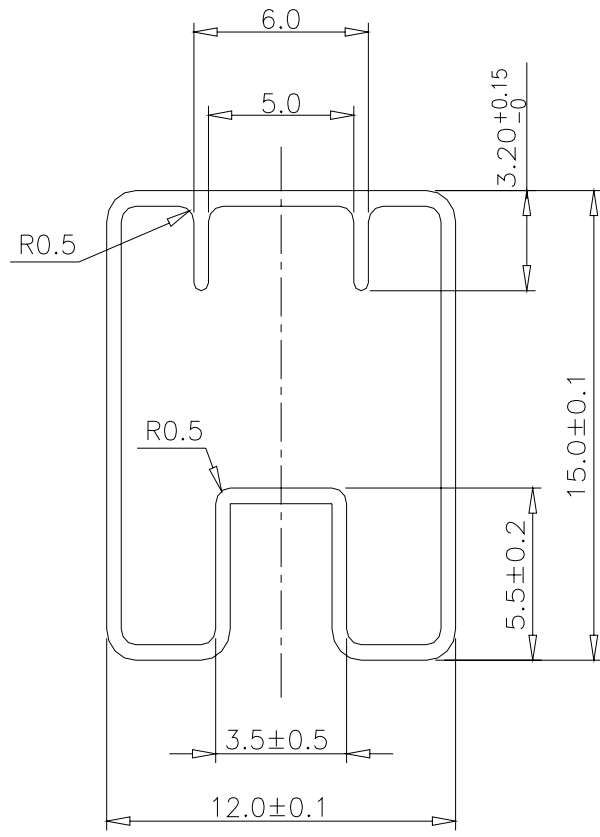

General Tolerance : $\pm 0.2\text{mm}$

DS

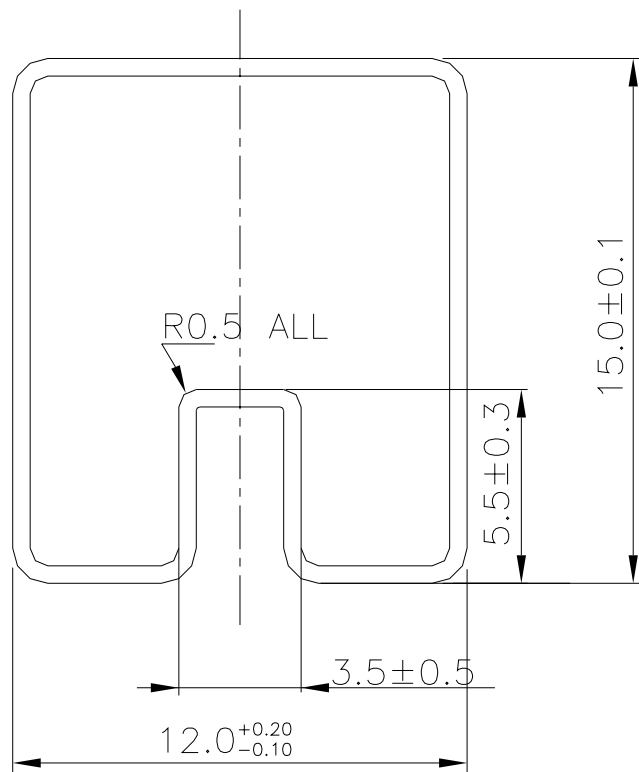

General Tolerance : $\pm 0.2\text{mm}$

DP(L)

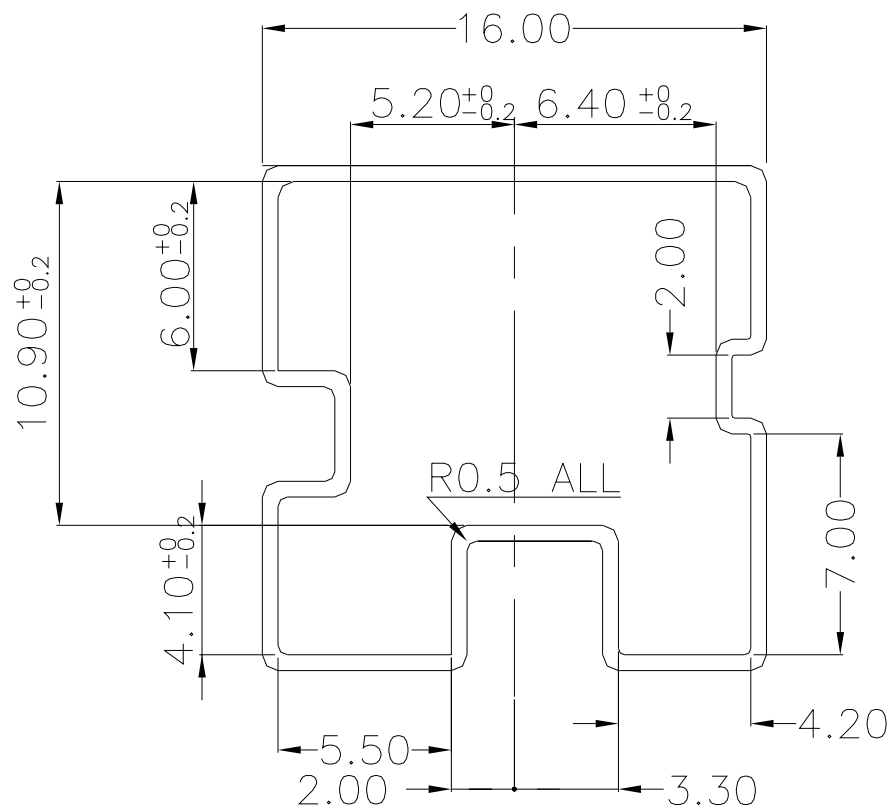

General Tolerance : $\pm 0.2\text{mm}$

DA

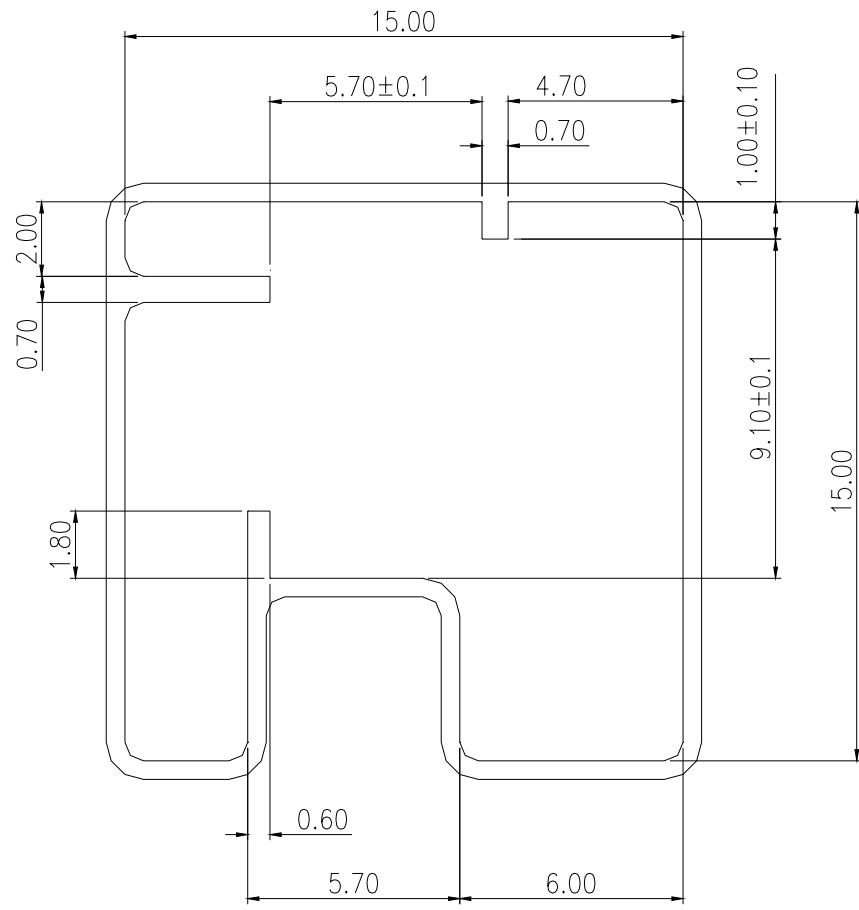

General Tolerance : $\pm 0.2\text{mm}$