

# Technical datasheet: KPCM-G97H45-43DB-1186

## Specifications:

Standard operation voltage	4.5VDC
Max operating voltage	10VDC
Output impedance	2.2k $\Omega$
Frequency	100 Hz to 10,000 Hz
Sensitivity	-43dB $\pm$ 3dB
Sensitivity reduction	-3dB
Max. Current Consumption	0.5mA
Signal to noise ration	60dB
Directivity	Omni-directional

## Dimensions:

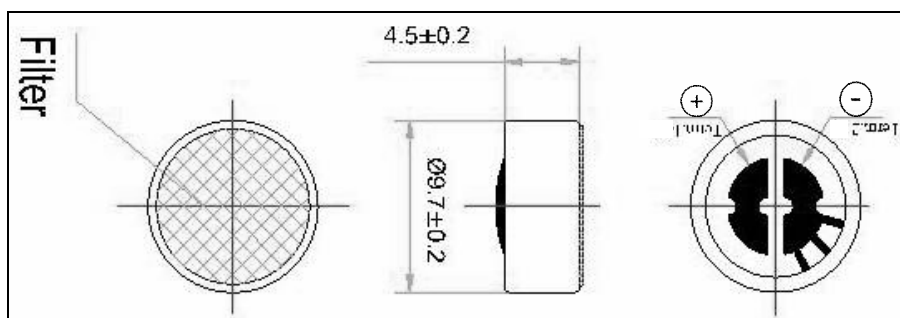

## Frequency Response:

