

Technical datasheet: KPX-G1203UB-K6397

Specifications:

Operating Temperature	-20°C to +70°C
Storage Temperature	-30°C to +80°C
Rated Voltage	3 VDC
Operating Voltage	2VDC to 5VDC
Max. Rated Current	30mA at 3 VDC
Resonant Frequency	2.3kHz±0.5kHz
Min SPL	85dB/ 3VDC/ 10cm
Weight	2g
Case Material/Color	PBT/Black
Tone Nature	Continuous

Dimensions:

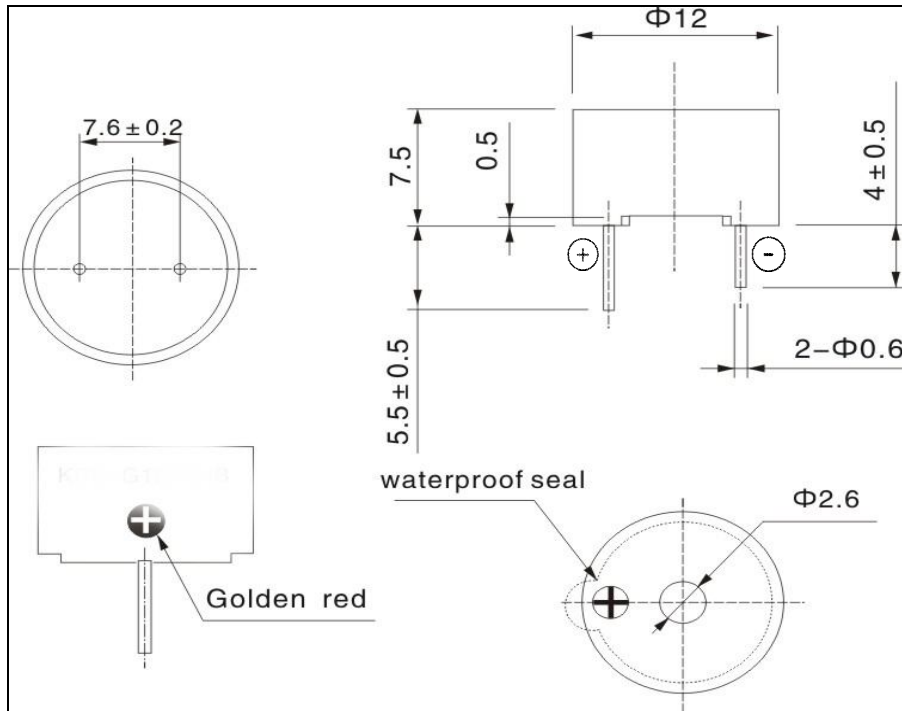

Frequency Response:

