

# Sensor/actuator box - SACB-8/16-L-10,0PUR SCO P - 1452738

Please be informed that the data shown in this PDF Document is generated from our Online Catalog. Please find the complete data in the user's documentation. Our General Terms of Use for Downloads are valid (<http://download.phoenixcontact.com>)



Sensor/actuator box, Connection method: M12-SPEEDCON-socket Plastic, Number of slots: 8, Number of positions: 5, Slot assignment: Double, Status indication: Yes, prnp; Master cable connection: Fixed connection 180°, PUR/PVC, Cable length: 10 m, Shielding: No

## Product Features

- Safety in the field, thanks to molded housing and high degree of protection
- Flexible, distributed bundling of signals in one master cable
- Convenient: increased machine availability thanks to quick and easy diagnostics
- Save space: distributor box with double occupancy for two sensors in one slot
- Save time, thanks to installation with SPEEDCON rapid interlock system



## Key commercial data

package_quantity	1
GTIN	4046356554015

## Technical data

### General

Rated voltage	24 V DC
Max. operating voltage $U_{max}$	30 V DC
Current carrying capacity per I/O signal	2 A
Current carrying capacity per slot	4 A
Total rated current	12 A
Number of positions	5
Number of slots	8
Sensor/actuator connection system	M12-SPEEDCON-socket

### Ambient conditions

Degree of protection	IP65
Degree of protection	IP67
Ambient temperature (operation)	-25 °C ... 80 °C
Ambient temperature (operation)	-40 °C ... 90 °C (for fixed installation)
Ambient temperature (operation)	-5 °C ... 80 °C (for flexible installation)

### Local diagnostics function

Local diagnostics	Supply voltage Green LED
-------------------	--------------------------

# Sensor/actuator box - SACB-8/16-L-10,0PUR SCO P - 1452738

## Technical data

### Local diagnostics function

Local diagnostics	Status display I/O Yellow LED
-------------------	-------------------------------

### Master cable connection data

Connection method	Fixed connection
Length of cable	10 m
Tightening torque slot sensor/actuator cable	0.4 Nm
Tightening torque screw plug	0.4 Nm

### Insulation material

Housing material	PBT
Material of the moulding mass	PUR
Contact material	Cu alloy
Contact surface material	Gold-plated
Contact carrier material	PA
Material of threaded sleeve	PBT
Material, O-ring	NBR

### Pin assignment

Slot/position = Wire color or connection	1 / 4 (A) = WH
Slot/position = Wire color or connection	1 / 2 (B) = GY/PK
Slot/position = Wire color or connection	2 / 4 (A) = GN
Slot/position = Wire color or connection	2 / 2 (B) = RD/BU
Slot/position = Wire color or connection	3 / 4 (A) = YE
Slot/position = Wire color or connection	3 / 2 (B) = WH/GN
Slot/position = Wire color or connection	4 / 4 (A) = GY
Slot/position = Wire color or connection	4 / 2 (B) = BN/GN
Slot/position = Wire color or connection	5 / 4 (A) = PK
Slot/position = Wire color or connection	5 / 2 (B) = WH/YE
Slot/position = Wire color or connection	6 / 4 (A) = RD
Slot/position = Wire color or connection	6 / 2 (B) = YE/BN
Slot/position = Wire color or connection	7 / 4 (A) = BK
Slot/position = Wire color or connection	7 / 2 (B) = WH/GY
Slot/position = Wire color or connection	8 / 4 (A) = VT
Slot/position = Wire color or connection	8 / 2 (B) = GY/BN
Slot/position = Wire color or connection	1-4 / 1 (+ 24 V) = BN
Slot/position = Wire color or connection	1-8 / 3 (0 V) = BU
Slot/position = Wire color or connection	1-8 / 5 (PE) = GN/YE

### Cable

Cable type	PUR/PVC black
Cable type (abbreviation)	PUR
Cable abbreviation	LiYY11Y-HF
UL AWM style	20549 (80°C/300 V)
Conductor cross section	16x 0.5 mm <sup>2</sup> (signal line)

## Sensor/actuator box - SACB-8/16-L-10,0PUR SCO P - 1452738

### Technical data

#### Cable

<b>Conductor cross section</b>	3x 1 mm <sup>2</sup> (power line)
<b>AWG signal line</b>	20
<b>AWG power supply</b>	17
<b>Conductor structure signal line</b>	28x 0.15 mm
<b>Conductor structure, voltage supply</b>	56x 0.15 mm
<b>Core diameter including insulation</b>	1.5 mm ±0.1 mm (signal line)
<b>Core diameter including insulation</b>	2.1 mm ±0.1 mm (power line)
<b>Wire colors</b>	Brown, blue, green-yellow, white, green, yellow, gray, pink, red, black, violet, gray-pink, red-blue, white-green, brown-green, white-yellow, yellow-brown, white-gray, gray-brown
<b>Overall twist</b>	Wires twisted in layers
<b>External sheath, color</b>	Black RAL 9005
<b>Inner sheath thickness</b>	≥ 0.15 mm
<b>Outer sheath thickness</b>	≥ 0.76 mm
<b>External cable diameter D</b>	10.5 mm ± 0.2 mm
<b>Minimum bending radius, fixed installation</b>	7.5 x D
<b>Minimum bending radius, flexible installation</b>	10 x D
<b>Number of bending cycles</b>	1500000
<b>Minimum bending radius, drag chain applications</b>	10 x D
<b>Traversing path</b>	2 m
<b>Traversing rate</b>	2 m/s
<b>Cable weight</b>	183.7 kg/km
<b>Outer sheath, material</b>	PUR
<b>Material, inner sheath</b>	PVC
<b>Material conductor insulation</b>	PVC
<b>Conductor material</b>	Bare Cu litz wires
<b>Nominal voltage, cable</b>	300 V
<b>Test voltage, cable</b>	2000 V
<b>Special properties</b>	Silicone-free
<b>Flame resistance</b>	According to DIN EN 50265
<b>Resistance to oil</b>	As per VDE 0472 Part 803
<b>Other resistance</b>	Highly resistant to acids, alkaline solutions and solvents
<b>Ambient temperature (operation)</b>	-40 °C ... 90 °C (cable, fixed installation)
<b>Ambient temperature (operation)</b>	-5 °C ... 80 °C (cable, flexible installation)

### classifications

#### eCl@ss

<b>eCl@ss 4.0</b>	27140815
<b>eCl@ss 4.1</b>	27140815
<b>eCl@ss 5.0</b>	27143423
<b>eCl@ss 5.1</b>	27143423

# Sensor/actuator box - SACB-8/16-L-10,0PUR SCO P - 1452738

## classifications

### eCl@ss

eCl@ss 6.0	27279219
eCl@ss 7.0	27279219
eCl@ss 8.0	27279219

### ETIM

ETIM 4.0	EC002585
ETIM 5.0	EC002585

### UNSPSC

UNSPSC 6.01	31261501
UNSPSC 7.0901	31261501
UNSPSC 11	31261501
UNSPSC 12.01	31261501
UNSPSC 13.2	31261501

## approvals

UL Recognized / cUL Recognized / GOST / cULus Recognized /

### Approval details

<b>UL Recognized</b> 	
Nominal voltage UN	24 V
Nominal current IN	
mm <sup>2</sup> /AWG/kcmil	

<b>cUL Recognized</b> 	
Nominal voltage UN	24 V
Nominal current IN	
mm <sup>2</sup> /AWG/kcmil	

<b>GOST</b> 	
---	--

# Sensor/actuator box - SACB-8/16-L-10,0PUR SCO P - 1452738

approvals

cULus Recognized  US

accessories

**Protective cap**

PROT-MS SCO - 1553129



---

**Device marking**

SS-ZB 17,5 WH - 0804963



SS-ZB 17,5 YE - 0804976



---

**Labeled device marker**

SS-ZB 17,5 WH CUS - 0824468



## Sensor/actuator box - SACB-8/16-L-10,0PUR SCO P - 1452738

### accessories

SS-ZB 17,5 YE CUS - 0824469



---

### Torque tool

TSD 04 SAC - 1208429



---

### Screwdriver tools

SAC BIT M12-D15 - 1208432



SACC BIT M12-D20 - 1208445



---

### Drawings

# Sensor/actuator box - SACB-8/16-L-10,0PUR SCO P - 1452738

Dimensioned drawing

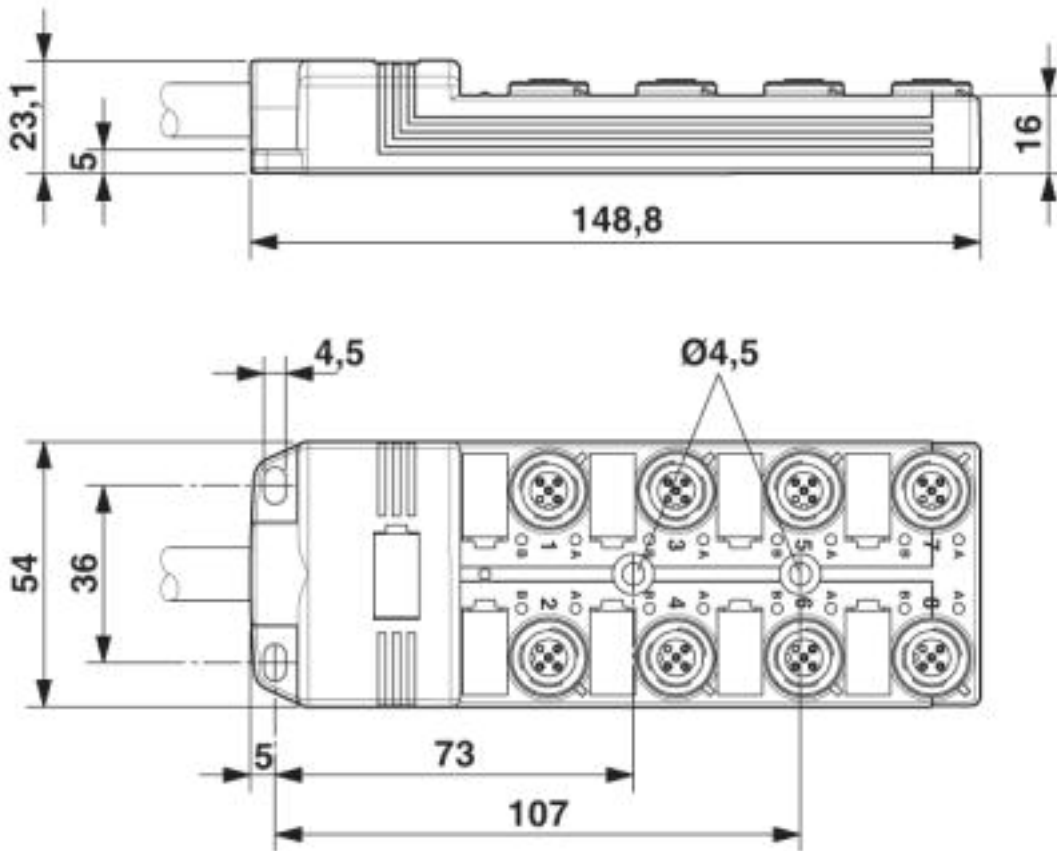

Circuit diagram

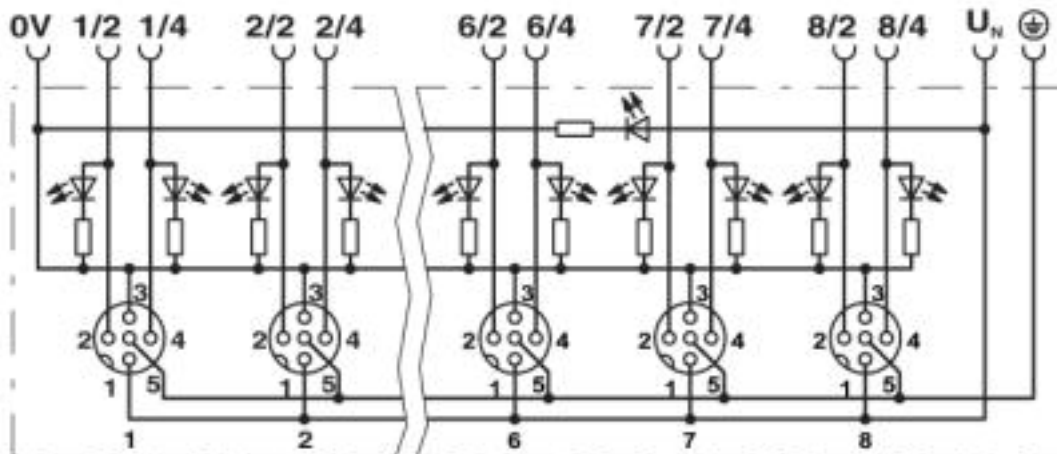

# Sensor/actuator box - SACB-8/16-L-10,0PUR SCO P - 1452738

Schematic diagram

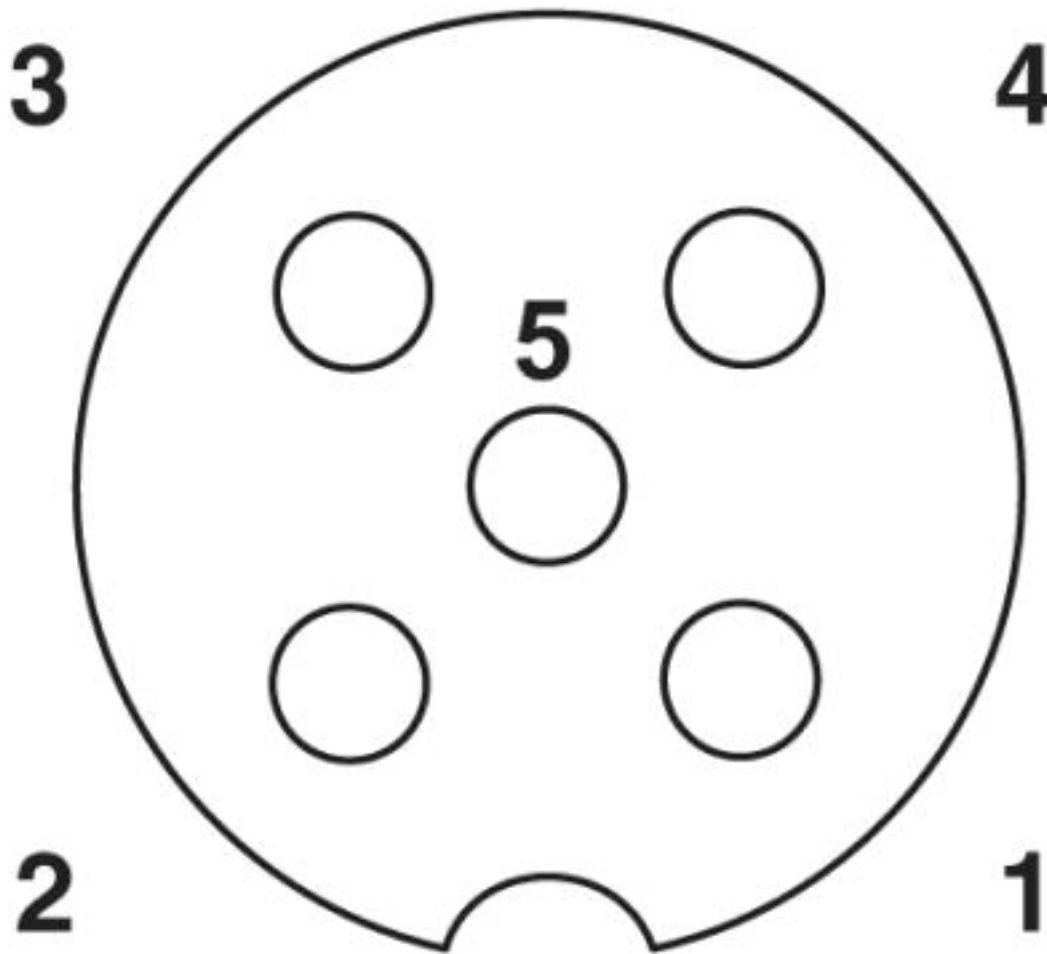

M12 slot, socket, 5-pos.



## Sensor/actuator box - SACB-8/16-L-10,0PUR SCO P - 1452738

Cable cross section

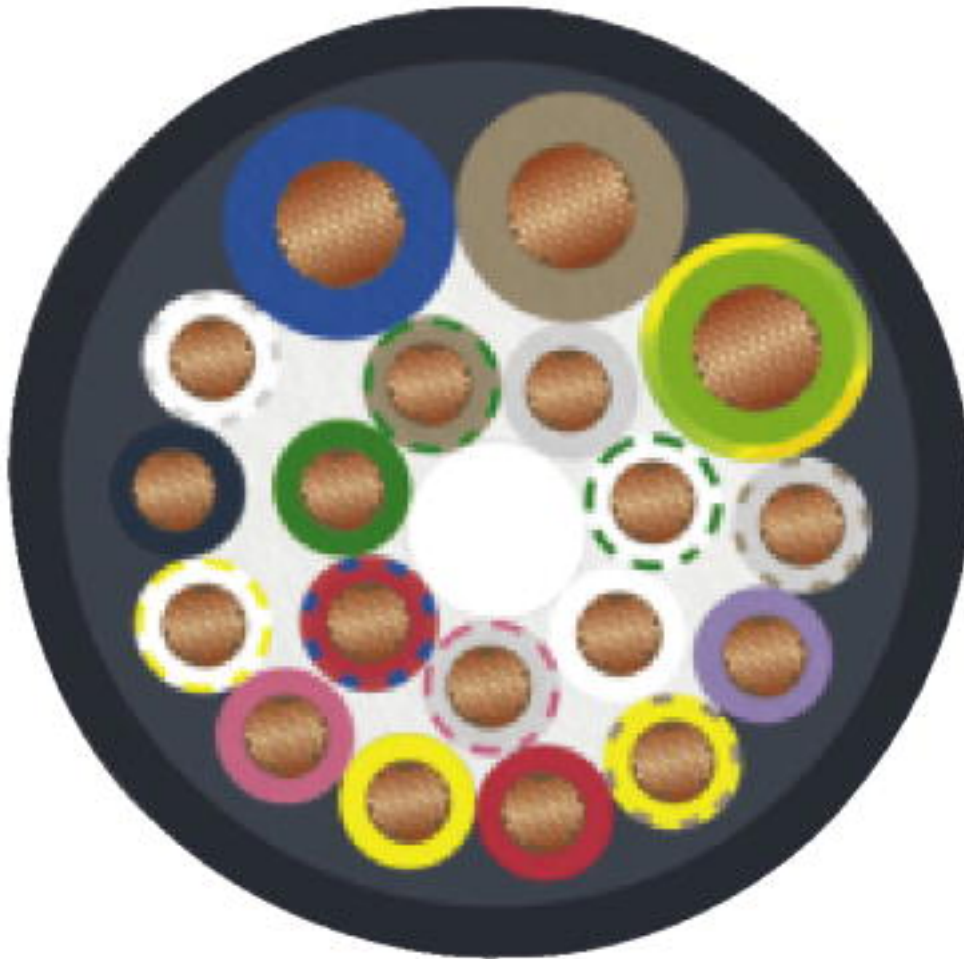

PUR/PVC black [PUR]

© Phoenix Contact 2013 - all rights reserved  
<http://www.phoenixcontact.com>