

FO converters - PSI-MOS-PROFIB/FO1300 T - 2708892

Please be informed that the data shown in this PDF Document is generated from our Online Catalog. Please find the complete data in the user's documentation. Our General Terms of Use for Downloads are valid (<http://download.phoenixcontact.com>)



Fiber optic converter with integrated optical diagnostics, alarm contact, for PROFIBUS up to 12 Mbps, T-coupler with two fiber optic interfaces (SC-Duplex), 1300 nm, for fiberglass cable

Product Features

- Supply voltage and data signals routed through via DIN rail connectors
- Can be combined with the PSI copper repeater in a modular way using DIN rail connectors
- Connections can be plugged in using a COMBICON screw terminal block
- Automatic data rate detection or fixed data rate setting via DIP switches
- Redundant power supply possible by means of optional system power supply unit
- High-quality electrical isolation between all interfaces (PROFIBUS // fiber optic ports // power supply // DIN rail connector)
- Approved for use in zone 2
- Integrated optical diagnostics for continuous monitoring of fiber optic paths
- Floating switch contact for leading alarm generation in relation to critical fiber optic paths
- Bit retiming for any cascading depth
- Suitable for all data rates up to 12 Mbps



Key commercial data

package_quantity	1
GTIN	4046356174053

Technical data

Note:

Utilization restriction	EMC: class A product, see manufacturer's declaration in the download area
--------------------------------	---

Dimensions

Width	35 mm
Height	105 mm
Depth	106 mm

Ambient conditions

Ambient temperature (operation)	-20 °C ... 60 °C
Ambient temperature (storage/transport)	-40 °C ... 85 °C
Permissible humidity (operation)	30 % ... 95 % (no condensation)

FO converters - PSI-MOS-PROFIB/FO1300 T - 2708892

Technical data

Ambient conditions

Altitude	5000 m (For restrictions see manufacturer's declaration)
Degree of protection	IP20
Noise immunity	EN 61000-6-2:2005

Serial interface

Interface 1	PROFIBUS acc. to IEC 61158, RS-485 2-wire, half duplex, automatic control
Operating mode	Semi-duplex
Connection method	D-SUB-9 female connector
File format/coding	UART (11 Bit, NRZ)
Data direction switching	Automatic control
Transmission medium	Copper
Transmission length	max. 1200 m (depending on the data rate, with shielded, twisted pair data cable)
Conductor cross section solid min.	0.2 mm ²
Conductor cross section solid max.	2.5 mm ²
Conductor cross section stranded min.	0.2 mm ²
Conductor cross section stranded max.	2.5 mm ²
Conductor cross section AWG/kcmil min.	24
Conductor cross section AWG/kcmil max	14
Serial transmission speed	≤ 12 Mbps

Optical interface FO

Wavelength	1300 nm
Transmission length incl. 3 dB system reserve	25 km (With F-G 50/125 0.7 dB/km at 1300 nm)
Transmission length incl. 3 dB system reserve	22 km (with F-G 62.5/125 0.8 dB/km at 1300 nm)
Transmission length incl. 3 dB system reserve	45 km (With F-E 9/125 0,4 dB/km at 1300 nm)
Transmission medium	Multi-mode fiberglass
Transmission medium	Single-mode fiberglass
Transmission protocol	Protocol-transparent to the RS-485 interface
Connection method	SC duplex

Fault warning output

Maximum switching voltage	60 V DC
Maximum switching voltage	42 V AC
Limiting continuous current	1 A

Power supply

Nominal supply voltage	24 V DC
Supply voltage range	18 V DC ... 32 V DC
Typical current consumption	170 mA (24 V DC)
Connection method	COMBICON plug-in screw terminal block

General

Bit distortion, input	± 35 % (permitted)
------------------------------	--------------------

FO converters - PSI-MOS-PROFIB/FO1300 T - 2708892

Technical data

General

Bit distortion, output	< 6.25 %
Electrical isolation	(VCC // RS-485)
Test voltage data interface/power supply	1.5 kV _{rms} (50 Hz, 1 min.)
Electromagnetic compatibility	Conformance with EMC directive 89/336/EC
Noise emission	EN 55011
Net weight	243 g
Housing material	PA 6.6-FR
Color	green
MTBF	307 Years (Telcordia standard, 25°C temperature, 21% operating cycle (5 days a week, 8 hours a day))
MTBF	64 Years (Telcordia standard, 40°C temperature, 34.25% operating cycle (5 days a week, 12 hours a day))
Conformance	CE-compliant
ATEX	# II 3 G Ex nA nC IIC T4 Gc X
UL, USA / Canada	508 listed
UL, USA / Canada	508 recognized

classifications

eCl@ss

eCl@ss 4.0	27230207
eCl@ss 4.1	27230207
eCl@ss 5.0	27230207
eCl@ss 5.1	27230207
eCl@ss 6.0	27230207
eCl@ss 7.0	27230207
eCl@ss 8.0	27230207

ETIM

ETIM 2.0	EC001423
ETIM 3.0	EC001423
ETIM 4.0	EC001423
ETIM 5.0	EC001423

UNSPSC

UNSPSC 6.01	30211506
UNSPSC 7.0901	39121008
UNSPSC 11	39121008
UNSPSC 12.01	39121008
UNSPSC 13.2	43201553

FO converters - PSI-MOS-PROFIB/FO1300 T - 2708892

approvals

ATEX / UL Recognized / cUL Recognized / UL Listed / cUL Listed / UL Recognized / UL Listed / cUL Recognized / cUL Listed / cULus Recognized / cULus Listed /

Approval details

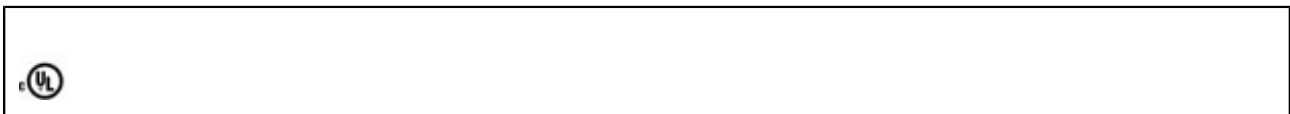
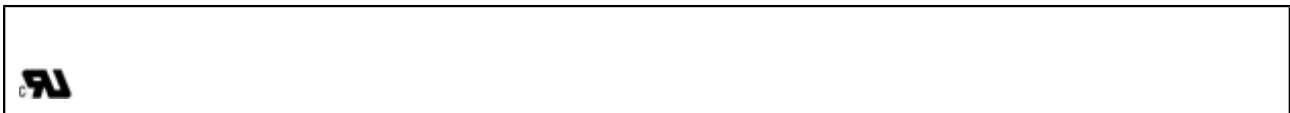
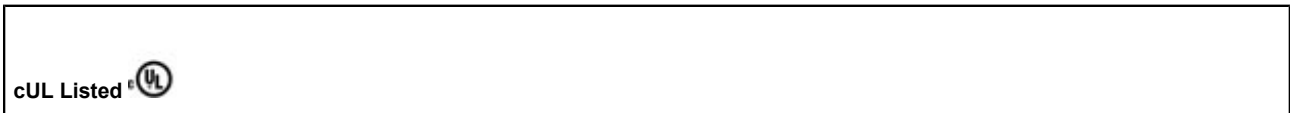
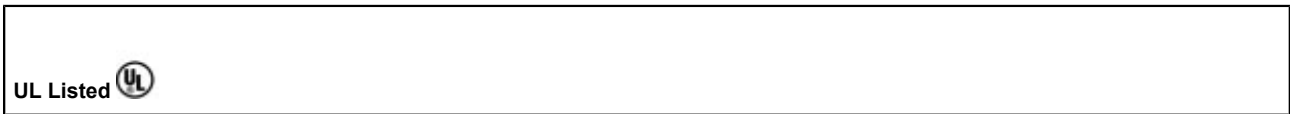
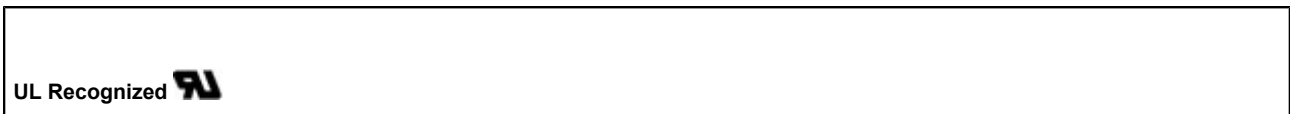

FO converters - PSI-MOS-PROFIB/FO1300 T - 2708892

approvals



accessories

Data cable preassembled

FL MM PATCH 1,0 LC-SC - 2989161



FL MM PATCH 2,0 LC-SC - 2989268



FL MM PATCH 5,0 LC-SC - 2901800



FL MM PATCH 1,0 SC-SC - 2901805



FO converters - PSI-MOS-PROFIB/FO1300 T - 2708892

accessories

FL MM PATCH 2,0 SC-SC - 2901807



FL MM PATCH 5,0 SC-SC - 2901808



FL MM PATCH 1,0 SC-ST - 2901809



FL MM PATCH 2,0 SC-ST - 2901810



FL MM PATCH 5,0 SC-ST - 2901811



FL MM PATCH 1,0 SC-SCRJ - 2901812



FO converters - PSI-MOS-PROFIB/FO1300 T - 2708892

accessories

FL MM PATCH 2,0 SC-SCRJ - 2901813



FL MM PATCH 5,0 SC-SCRJ - 2901814



FL SM PATCH 1,0 LC-SC - 2989190



FL SM PATCH 2,0 LC-SC - 2989297



FL SM PATCH 5,0 LC-SC - 2901827



FO converters - PSI-MOS-PROFIB/FO1300 T - 2708892

accessories

FL SM PATCH 1,0 SC-SC - 2901829



FL SM PATCH 2,0 SC-SC - 2901830



FL SM PATCH 5,0 SC-SC - 2901831



FL SM PATCH 1,0 SC-ST - 2901832



FL SM PATCH 2,0 SC-ST - 2901833



FL SM PATCH 5,0 SC-ST - 2901834



FO converters - PSI-MOS-PROFIB/FO1300 T - 2708892

accessories

FOC-GDM-RUGGED-1016/IP20/... - 2901558



FOC-GDM-RUGGED-1016/... - 1402193



FOC-GDO-1017/IP20/... - 2901559



FOC-GDO-1017/... - 1402194



Data cable by the meter

PSM-LWL-GDO- 50/125 - 2799432



FO converters - PSI-MOS-PROFIB/FO1300 T - 2708892

accessories

PSM-LWL-GDM-RUGGED- 50/125 - 2799322



Data plug

SUBCON-PLUS-PROFIB/90/P/SC - 2313708



SUBCON-PLUS-PROFIB/90/P/IDC - 2313685



Drawings

FO converters - PSI-MOS-PROFIB/FO1300 T - 2708892

Application drawing

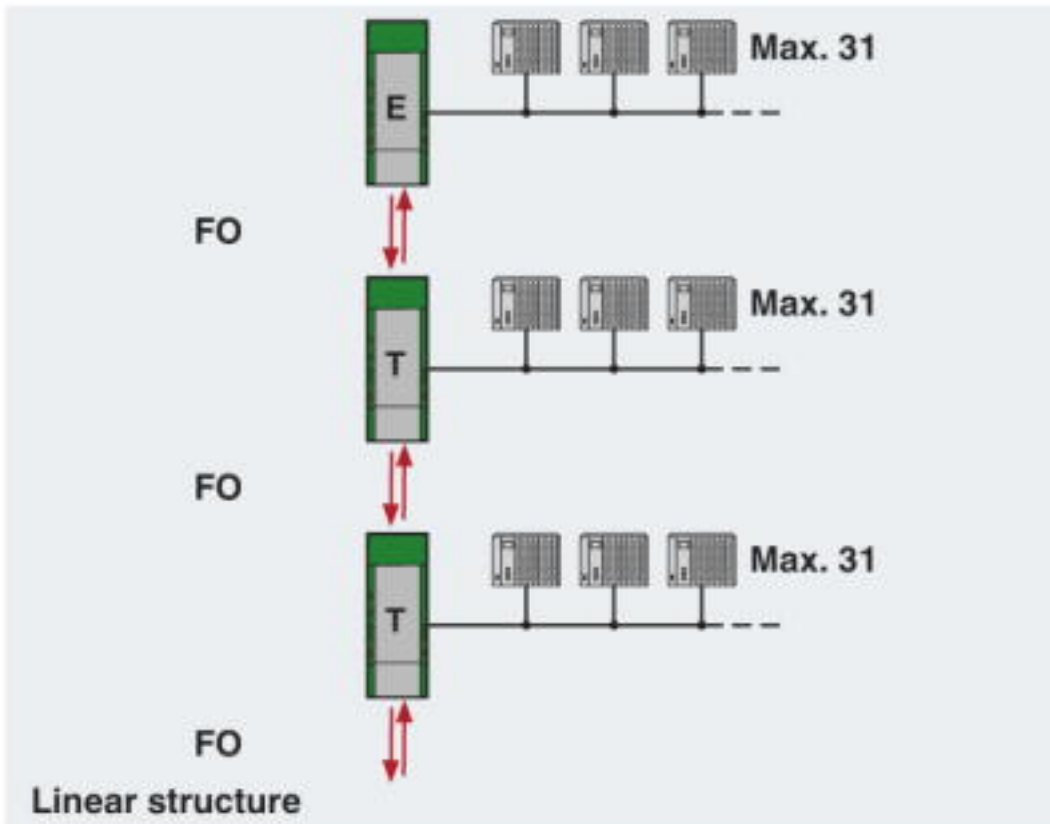

FO converters - PSI-MOS-PROFIB/FO1300 T - 2708892

Application drawing

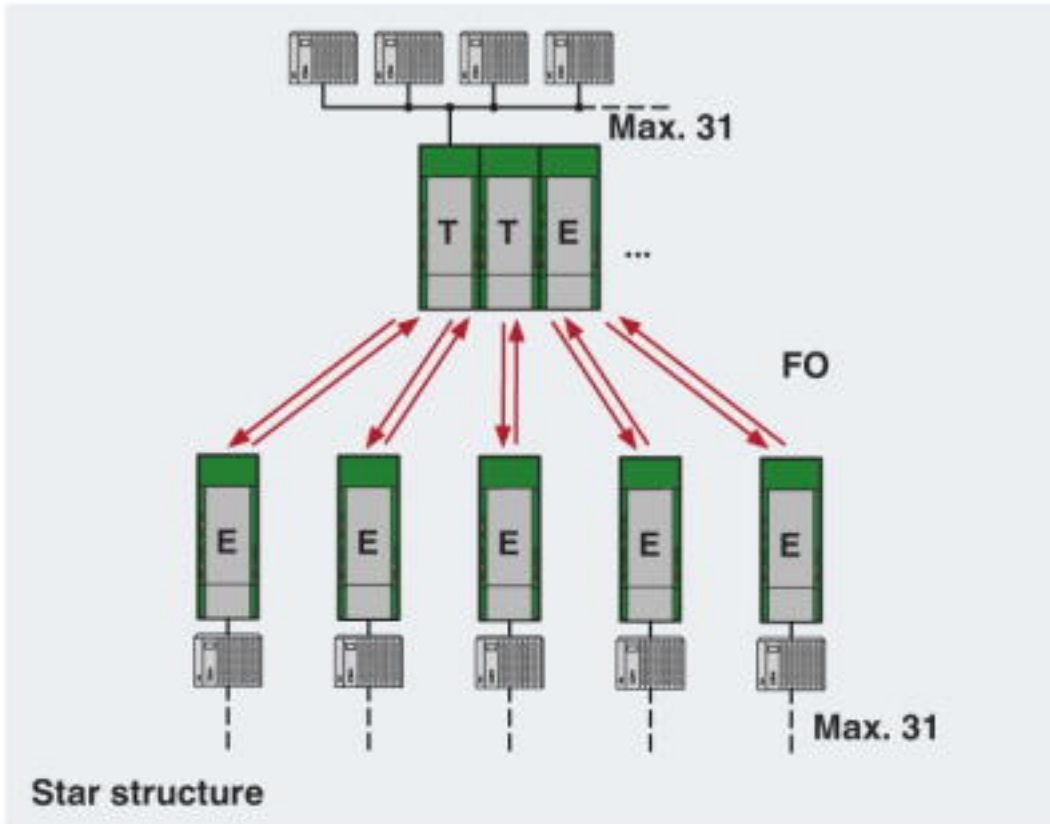

FO converters - PSI-MOS-PROFIB/FO1300 T - 2708892

Application drawing

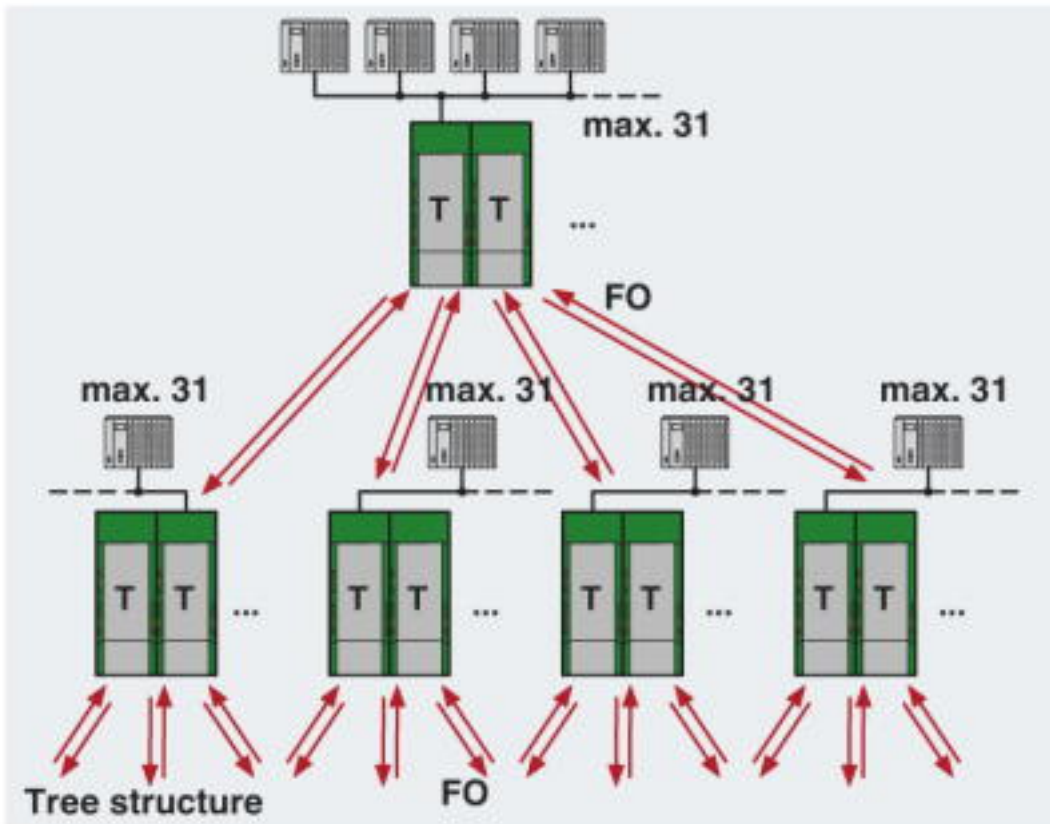

FO converters - PSI-MOS-PROFIB/FO1300 T - 2708892

Application drawing

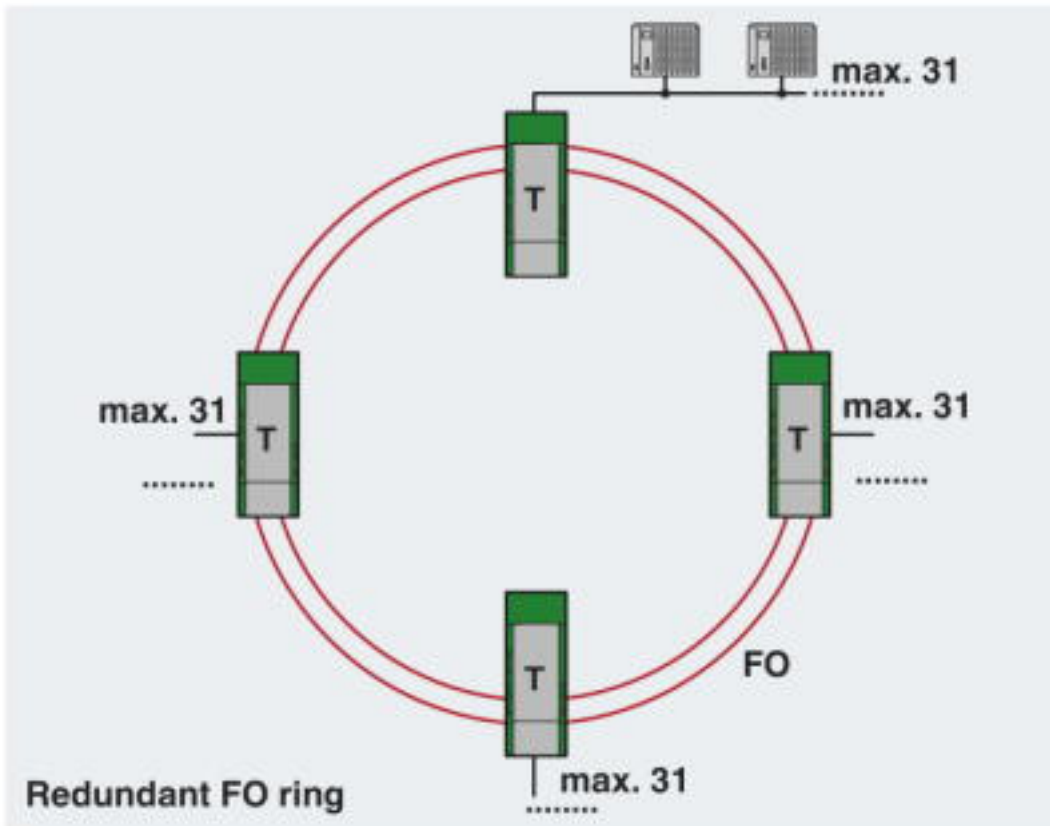

FO converters - PSI-MOS-PROFIB/FO1300 T - 2708892

Application drawing

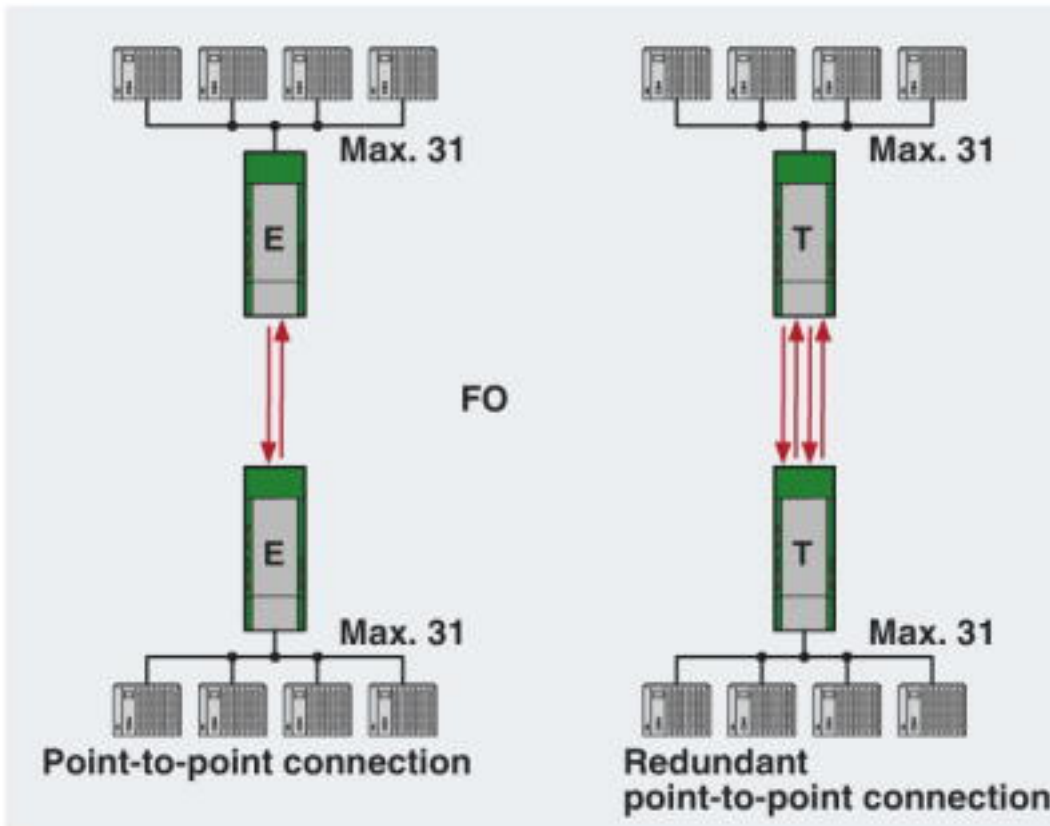

© Phoenix Contact 2013 - all rights reserved
<http://www.phoenixcontact.com>