

## LAS1 Series A Type Pushbutton Switches

### Characteristic

#### Specs

Having three head shape: round ( $\Phi 18\text{mm}$ ), square ( $18 \times 18\text{mm}$ ) and rectangular ( $18 \times 24\text{mm}$ ), containing pilot lamps, pushbuttons, illuminated push buttons, selector switches, key-lock switches, buzzer and emergency switches. The normal diameter of the installation hole is  $\Phi 16\text{mm}$ , and some type can be installed in  $\Phi 22\text{mm}$  hole easily with the diameter changing circle.

#### Functions

The product has stable property, small contact resistance, strong insulation resistance, anti-vibration and so on. It meets to standards of IEC60947-5-1, GB14048.5 etc.

#### Structure

The switch have the advantage of fast-break and self-cleaning, and each of them contains 1NO and 1NC terminal. Every pushbutton also can possess from one to two switch units.

#### Protective Degree

Its protective degree is IP40, IP65, some of type can reach IP67 with the seal cover.

### Lamp Ratings

Lamp Type	AC LED Lamp (Standard)			Neon Lamp		
	AC/DC6V	AC/DC12V	AC/DC24V	AC110V	AC230V	
Rated Voltage	AC/DC110V		AC/DC230V			
Cover Color:	R	G	Y	O	B	W
Life	About 40,000 hours			About 20,000 hours		

Note: the lamp contains a current-limiting resistor inside and doesn't need external connection.

DC LED lamp, dual-color LED lamp and other voltages can be customized.

### Installation Dimensions

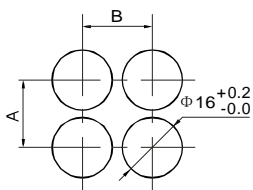

Category	A	B
Round	$\geq 18\text{mm}$	$\geq 18\text{mm}$
Square	$\geq 18\text{mm}$	$\geq 18\text{mm}$
Rectangular	$\geq 18\text{mm}$	$\geq 24\text{mm}$
Mushroom	$\geq 24\text{mm}$	$\geq 24\text{mm}$
Big square	$\geq 24\text{mm}$	$\geq 24\text{mm}$
Big rectangular	$\geq 18\text{mm}$	$\geq 24\text{mm}$

### Implication of Type

LAS1-A	★	-	□	■	/	◇	◆	/	△	/	▲	/	◎
Code of series	The front shape: Y round F square J rectangular M mushroom DF big square DJ big rectangular	Contact Structure: 11 1NO1NC 22 2NO2NC	Code name of derivative products: D pilot lamp Z alternate type X selector type Y key-lock type TS emergency B buzzer type No letter means momentary	◇: expresses selector and key-lock series: 2 two position 3 three position ◆: expresses key-lock retention position	color: : R red G green Y yellow O orange B blue W white N black	Lamp Voltage (Please check the lamp rating)	Protective Degree: P IP65 FP IP67 No letter means IP40						

### Switch Ratings

Thermal Current I <sub>th</sub>	5A		
Rated Voltage	24V	125V (110V)	250V (230V)
Direct Current	1A	0.2A	0.1A
Alternating Current	P.F=1	5A	3A
	P.F=0.7	3A	2A

### Specifications

Operating Temperature	-25°C ~ +55°C (no freezing)	
Operating Humidity	45 ~ 85%RH (no condensation)	
Contact Material	- silver - silver alloy - gold-clad silver, cladding thickness is 3 μm	
Contact Resistance	$\leq 50\text{M}\Omega$	
Insulation Resistance	$\geq 100\text{M}\Omega$	
Dielectric strength	Between contact and lamp terminals: 2000V, AC 50Hz, 1 min	
	Between terminal of the same pole: 1000V, AC 50Hz, 1 min	
	Between terminal of different pole: 2000V, AC 50Hz, 1 min	
Vibration Resistance	50Hz, Amplitude 1.2mm p-p	
Shock Resistance	$\geq 10\text{g}$	
Life	Mechanical	Momentary Type: 1,000,000 times Alternate and Selector Type: 500,000 times Key-lock and Emergency Type: 200,000 times
	Electrical	$\geq 50,000$ times
	Terminal	Diameter of welded wire: $2 \times 0.8\text{mm}$ Area of copper wire: $0.75\text{mm}^2$ max Connecting link: $2.8 \times 0.5\text{mm}$
	Solder Heat Resistance	230°C (no more than 3 second)
Operating Travel	(Pushbuttons) about 3mm	

### Bottom View

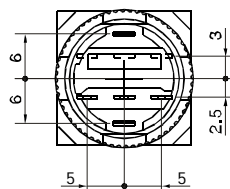

### Terminal Arrangement

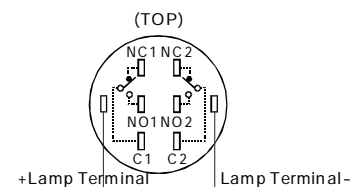

# LAS1 Series A Type Pushbutton Switches

## LAS1-A Pilot Lamp

### Product Outline

Model Number	LAS1-AY-D/ $\Delta$ / $\blacktriangle$ / $\bigcirc$	LAS1-AF-D/ $\Delta$ / $\blacktriangle$ / $\bigcirc$	LAS1-AJ-D/ $\Delta$ / $\blacktriangle$ / $\bigcirc$
Shape			
Remarks	<span style="color: red;">R</span> <span style="color: green;">G</span> <span style="color: yellow;">Y</span> <span style="color: orange;">O</span> <span style="color: blue;">B</span> <span style="border: 1px solid black; padding: 0 2px;">W</span>		



## LAS1-A Pushbuttons, Illuminated Pushbuttons

### Product Outline

Note: SPDT single - pole double - throw, DPDT double - pole double Throw.

Shape	Contact	Operating Type	Type Number	Remarks
Round (can be illuminated) 	SPDT	Momentary	LAS1-AY-11/ $\Delta$ / $\blacktriangle$ / $\bigcirc$	<div style="display: flex; justify-content: space-around; align-items: center;"> <span style="color: red;">R</span> <span style="color: green;">G</span> <span style="color: yellow;">Y</span> <span style="color: orange;">O</span> <span style="color: blue;">B</span> <span style="border: 1px solid black; padding: 0 2px;">W</span> <span style="border: 1px solid black; padding: 0 2px;">N</span> </div> <ul style="list-style-type: none"> <li><math>\bigcirc</math> The black cover can't be used with the illuminated push buttons</li> <li><math>\bigcirc</math> Protective Degree: IP40, IP65, IP67; IP67 should be installed with seal covers.</li> </ul>
		Alternate	LAS1-AY-11Z/ $\Delta$ / $\blacktriangle$ / $\bigcirc$	
	DPDT	Momentary	LAS1-AY-22/ $\Delta$ / $\blacktriangle$ / $\bigcirc$	
		Alternate	LAS1-AY-22Z/ $\Delta$ / $\blacktriangle$ / $\bigcirc$	
Square (can be illuminated) 	SPDT	Momentary	LAS1-AF-11/ $\Delta$ / $\blacktriangle$ / $\bigcirc$	
		Alternate	LAS1-AF-11Z/ $\Delta$ / $\blacktriangle$ / $\bigcirc$	
	DPDT	Momentary	LAS1-AF-22/ $\Delta$ / $\blacktriangle$ / $\bigcirc$	
		Alternate	LAS1-AF-22Z/ $\Delta$ / $\blacktriangle$ / $\bigcirc$	
Rectangular (can be illuminated) 	SPDT	Momentary	LAS1-AJ-11/ $\Delta$ / $\blacktriangle$ / $\bigcirc$	
		Alternate	LAS1-AJ-11Z/ $\Delta$ / $\blacktriangle$ / $\bigcirc$	
	DPDT	Momentary	LAS1-AJ-22/ $\Delta$ / $\blacktriangle$ / $\bigcirc$	
		Alternate	LAS1-AJ-22Z/ $\Delta$ / $\blacktriangle$ / $\bigcirc$	
Mushroom (can be illuminated) 	SPDT	Momentary	LAS1-AM-11/ $\Delta$ / $\blacktriangle$ / $\bigcirc$	<div style="display: flex; justify-content: space-around; align-items: center;"> <span style="color: red;">R</span> <span style="color: green;">G</span> <span style="color: yellow;">Y</span> </div> <ul style="list-style-type: none"> <li><math>\bigcirc</math> Protective Degree: IP40, IP65.</li> </ul>
		Alternate	LAS1-AM-11Z/ $\Delta$ / $\blacktriangle$ / $\bigcirc$	
	DPDT	Momentary	LAS1-AM-22/ $\Delta$ / $\blacktriangle$ / $\bigcirc$	
		Alternate	LAS1-AM-22Z/ $\Delta$ / $\blacktriangle$ / $\bigcirc$	

Note: SPDT signal-pole double-throw, DPDT double-pole double-throw.

Shape	Contact	Operating Type	Type Number	Remarks
Big Square(can be illuminated) 	SPDT	Momentary	LAS1-ADF-11/△/▲/◎	 ◎ Protective Degree: IP40, IP65.
		Alternate	LAS1-ADF-11Z/△/▲/◎	
	DPDT	Momentary	LAS1-ADF-22/△/▲/◎	
		Alternate	LAS1-ADF-22Z/△/▲/◎	
Big Rectangular(can be illuminated) 	SPDT	Momentary	LAS1-ADJ-11/△/▲/◎	
		Alternate	LAS1-ADJ-11Z/△/▲/◎	
	DPDT	Momentary	LAS1-ADJ-22/△/▲/◎	
		Alternate	LAS1-ADJ-22Z/△/▲/◎	



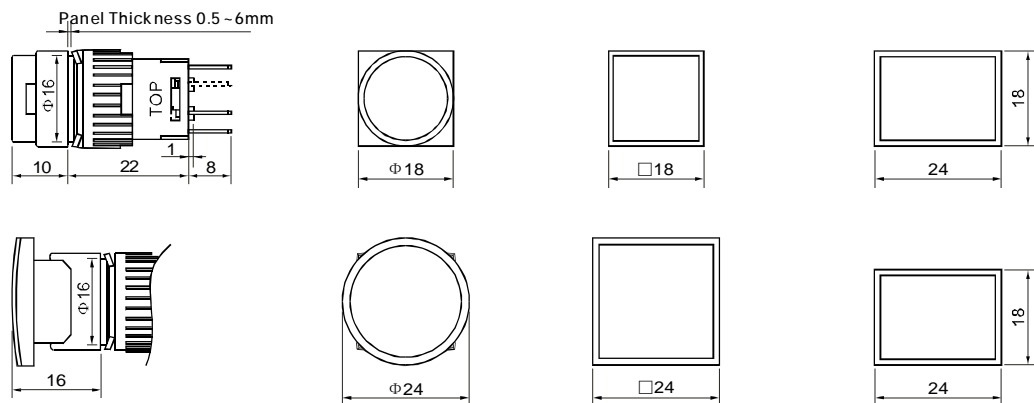





### Shape and Dimensions



# LAS1 Series A Type Pushbutton Switches

## LAS1-A Selector Switches



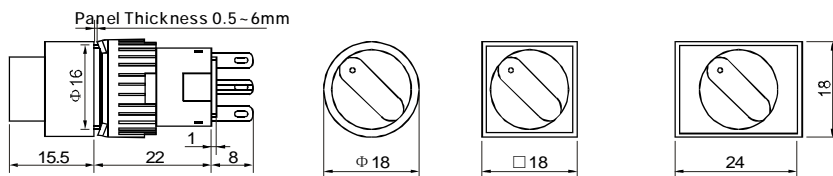

### Product Outline

Shape	Position	Contact	Type Number	Remarks
Round(can be illuminated) 	 90° 2 Position	SPDT	LAS1-AY-11X/2/△/▲/◎	<div style="display: flex; align-items: center; gap: 5px;"> <span style="background-color: red; color: white; padding: 2px;">R</span> <span style="background-color: green; color: white; padding: 2px;">G</span> <span style="background-color: yellow; color: black; padding: 2px;">Y</span> <span style="background-color: black; color: white; padding: 2px;">N</span> </div> <ul style="list-style-type: none"> <li>◎ The black cover can't be used with the illuminated push buttons</li> <li>◎ Protective Degree: IP40, IP65.</li> </ul>
		DPDT	LAS1-AY-22X/2/△/▲/◎	
	 45° 3 Position	DPDT	LAS1-AY-22X/3/△/▲/◎	
Square(can be illuminated) 	 90° 2 Position	SPDT	LAS1-AF-11X/2/△/▲/◎	
		DPDT	LAS1-AF-22X/2/△/▲/◎	
	 45° 3 Position	DPDT	LAS1-AF-22X/3/△/▲/◎	
Rectangular(can be illuminated) 	 90° 2 Position	SPDT	LAS1-AJ-11X/2/△/▲/◎	
		DPDT	LAS1-AJ-22X/2/△/▲/◎	
	 45° 3 Position	DPDT	LAS1-AJ-22X/3/△/▲/◎	

### Shape and Dimensions



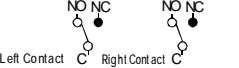

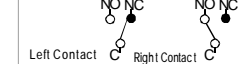









































### Contact Operation

Position	Contact	Operating Position & Contact Operation		
		Left	Center	Right
90° 2 Position	1C		/	
	2C		/	
45° 3 Position	2C			

## LAS1-A Key-lock Switches

### Product Cutline

Shape	Position	Key Retained at Position ●	Contact	Type	Remarks
<p>Round</p> 	<p>90° 2 Position</p> <p style="text-align: center;">L      R</p>		SPDT	LAS1-AY-11Y/2A/○	<ul style="list-style-type: none"> <li>○ Two keys are supplied.</li> <li>○ All the keys are same.</li> <li>○ Protective Degree: IP40, IP65</li> </ul>
			DPDT	LAS1-AY-22Y/2A/○	
			SPDT	LAS1-AY-11Y/2B/○	
			DPDT	LAS1-AY-22Y/2B/○	
			SPDT	LAS1-AY-11Y/2C/○	
			DPDT	LAS1-AY-22Y/2C/○	
	<p>45° 3 Position</p> <p style="text-align: center;">L      C      R</p>		DPDT	LAS1-AY-22Y/3A/○	
			DPDT	LAS1-AY-22Y/3B/○	
			DPDT	LAS1-AY-22Y/3C/○	
			DPDT	LAS1-AY-22Y/3D/○	
			DPDT	LAS1-AY-22Y/3E/○	
			DPDT	LAS1-AY-22Y/3G/○	
			DPDT	LAS1-AY-22Y/3H/○	
			DPDT	LAS1-AY-22Y/3H/○	
<p>Square</p> 	<p>90° 2 Position</p> <p style="text-align: center;">L      R</p>		SPDT	LAS1-AF-11Y/2A/○	
			DPDT	LAS1-AF-22Y/2A/○	
			SPDT	LAS1-AF-11Y/2B/○	
			DPDT	LAS1-AF-22Y/2B/○	
			SPDT	LAS1-AF-11Y/2C/○	
			DPDT	LAS1-AF-22Y/2C/○	
	<p>45° 3 Position</p> <p style="text-align: center;">L      C      R</p>		DPDT	LAS1-AF-22Y/3A/○	
			DPDT	LAS1-AF-22Y/3B/○	
			DPDT	LAS1-AF-22Y/3C/○	
			DPDT	LAS1-AF-22Y/3D/○	
			DPDT	LAS1-AF-22Y/3E/○	
			DPDT	LAS1-AF-22Y/3G/○	
			DPDT	LAS1-AF-22Y/3H/○	
			DPDT	LAS1-AF-22Y/3H/○	
<p>rectangular</p> 	<p>90° 2 Position</p> <p style="text-align: center;">L      R</p>		SPDT	LAS1-AJ-11Y/2A/○	
			DPDT	LAS1-AJ-22Y/2A/○	
			SPDT	LAS1-AJ-11Y/2B/○	
			DPDT	LAS1-AJ-22Y/2B/○	
			SPDT	LAS1-AJ-11Y/2C/○	
			DPDT	LAS1-AJ-22Y/2C/○	
	<p>45° 3 Position</p> <p style="text-align: center;">L      C      R</p>		DPDT	LAS1-AJ-22Y/3A/○	
			DPDT	LAS1-AJ-22Y/3B/○	
			DPDT	LAS1-AJ-22Y/3C/○	
			DPDT	LAS1-AJ-22Y/3D/○	
			DPDT	LAS1-AJ-22Y/3E/○	
			DPDT	LAS1-AJ-22Y/3G/○	
			DPDT	LAS1-AJ-22Y/3H/○	
			DPDT	LAS1-AJ-22Y/3H/○	

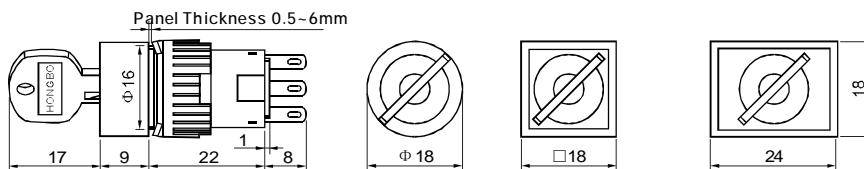

### Shape and Dimensions



# LAS1 Series A Type Pushbutton Switches

## LAS1-A Emergency Pushbutton

### Product Cutline

Shape	Contact	Type Number	Remrks
	SPDT	LAS1-AY-11TS/Δ/⊙	 ⊙ Protective Degree: IP40, IP65
	DPDT	LAS1-AY-22TS/Δ/⊙	

### Shape and Dimensions

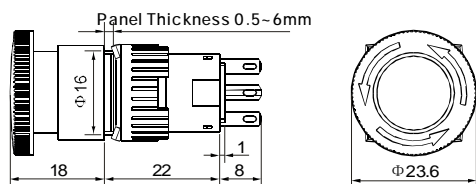

## LAS1-A Buzzer Units

### Specifications

Operating Temperature	-25°C ~ 55°C
Operating Humidity	45 - 85%RH
Dielectric Strength	1000V
Sound Duration	Continuous, Discontinuous
Rated Sound Pressure & Frequency	75dB(1m)(Rated Voltage) 2300 ± 300Hz
Operating Voltage	6VDC; 12VDC; 24VDC; 110VAC; 230VAC
Rated Operating Current:	≤28 mA

### Shape and Dimensions

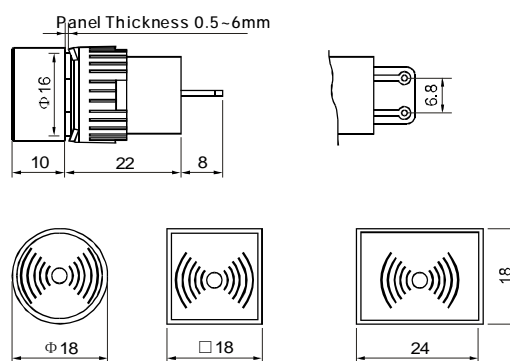

### Product Cutline

Type Number	LAS1-AY-B/▲	LAS1-AF-B/▲	LAS1-AJ-B/▲
Shape			