

# Ring cable lug - C-RCI 10/M8 - 3240221

Please be informed that the data shown in this PDF Document is generated from our Online Catalog. Please find the complete data in the user's documentation. Our General Terms of Use for Downloads are valid (<http://download.phoenixcontact.com>)



Ring cable lug, red, 10 mm<sup>2</sup>, M8

## Product Features

- The insulated ring cable lugs with plastic sleeve are hard-soldered and feature the 'EASY ENTRY' system
- The sleeves are conically tapered to facilitate easy and correct insertion of the conductor

## Key commercial data

<b>package_quantity</b>	50
<b>GTIN</b>	4046356452113

## Technical data

### Dimensions

<b>Length (b)</b>	37.3 mm
<b>Width (a)</b>	14 mm
<b>Length of insulation sleeve (c)</b>	16 mm
<b>Inner dimension of the insulating collar (d)</b>	7.5 mm
<b>Distance between the center and the insulation sleeve (e)</b>	13.8 mm
<b>Inner diameter (f)</b>	8.4 mm
<b>Material thickness (g)</b>	1.1 mm

### Ambient conditions

<b>Ambient temperature (operation)</b>	-20 °C ... 105 °C
--	-------------------

### General

<b>Color</b>	red
<b>Stripping length</b>	11 mm
<b>Components</b>	Halogen-free
<b>Inflammability class according to UL 94</b>	V2
<b>Material</b>	Copper

## classifications

### eCl@ss

<b>eCl@ss 4.0</b>	27060701
<b>eCl@ss 4.1</b>	27060701

# Ring cable lug - C-RCI 10/M8 - 3240221

## classifications

### eCl@ss

eCl@ss 5.0	27400201
eCl@ss 5.1	27400201
eCl@ss 6.0	27400201
eCl@ss 7.0	27400201
eCl@ss 8.0	27400201

### ETIM

ETIM 2.0	EC000005
ETIM 3.0	EC000005
ETIM 4.0	EC001052
ETIM 5.0	EC001052

### UNSPSC

UNSPSC 6.01	27113201
UNSPSC 7.0901	27121703
UNSPSC 11	27121703
UNSPSC 12.01	27121703
UNSPSC 13.2	27121703

## Drawings

# Ring cable lug - C-RCI 10/M8 - 3240221

Dimensioned drawing

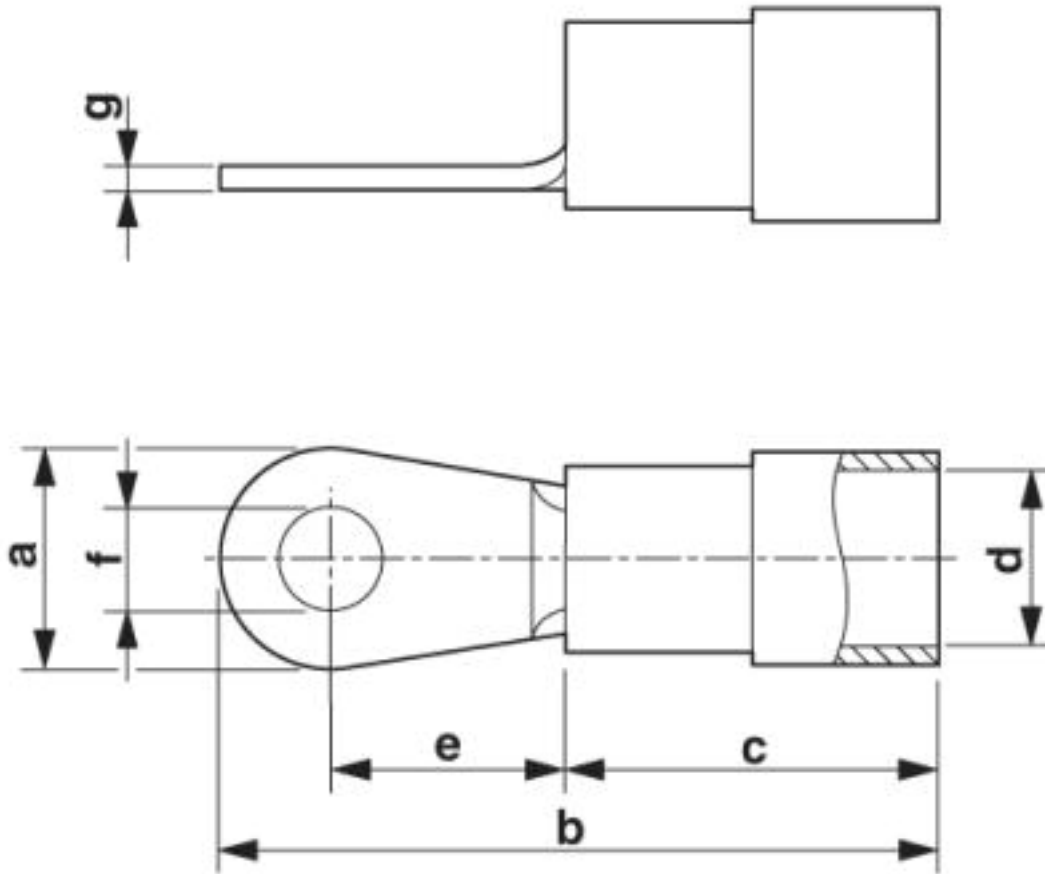

© Phoenix Contact 2013 - all rights reserved  
<http://www.phoenixcontact.com>