

Data sheet | Item number: 216-123

Ferrule; Sleeve for 1 mm² / AWG 18; uninsulated; electro-tin plated

www.wago.com/216-123

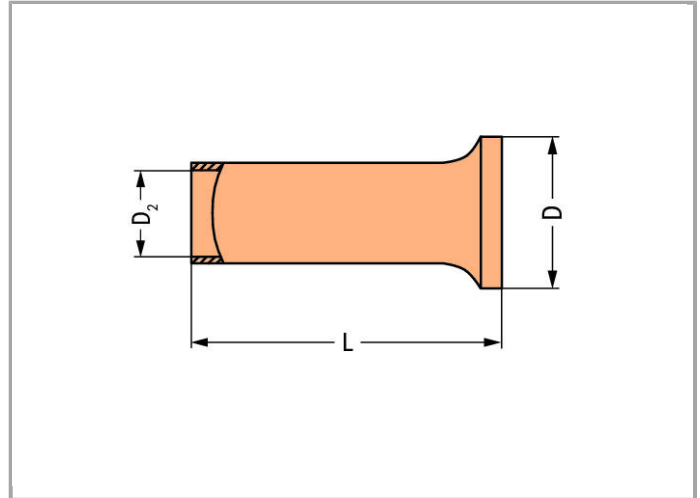
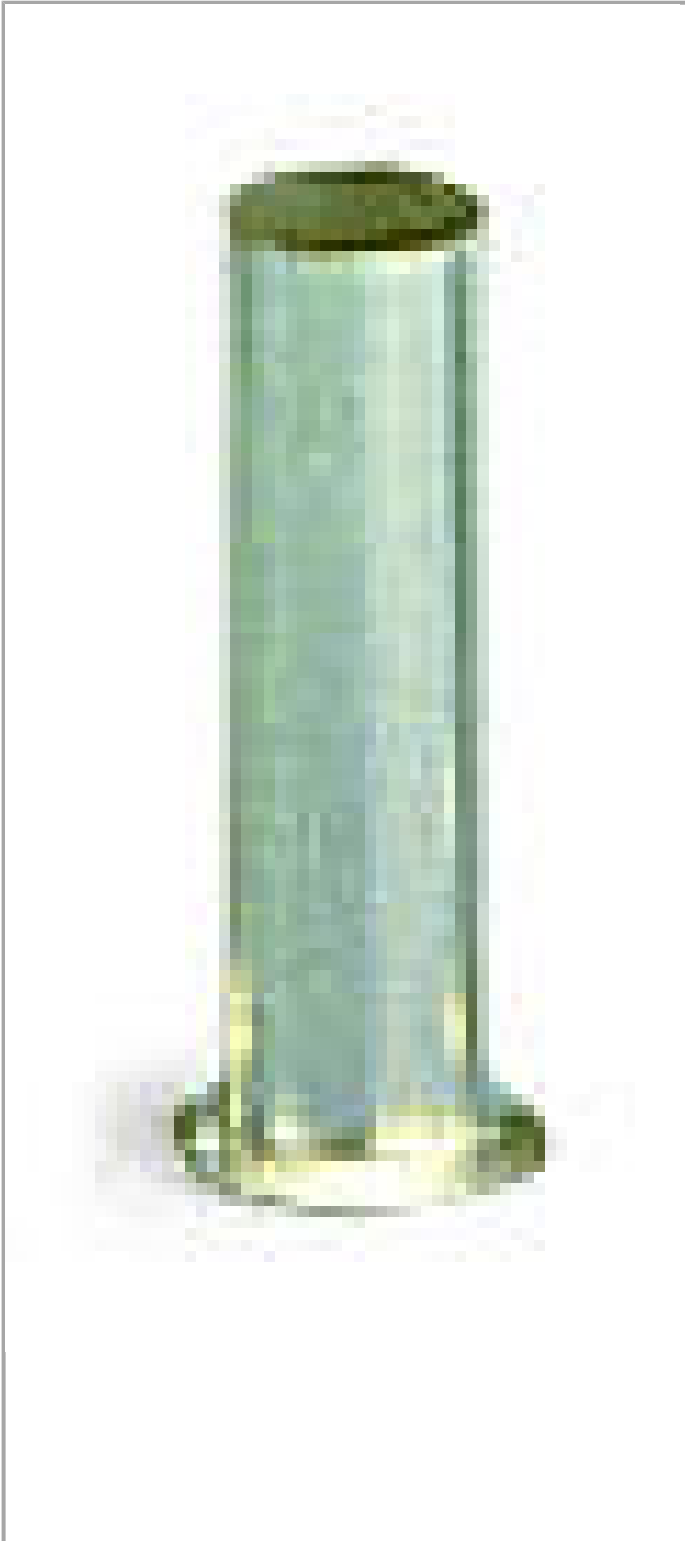

RoHS 
Compliant

[BOMcheck.net](https://www.bomcheck.net)

Data

Technical Data

Main product function	Ferrule
Querschnitt Hülse AWG	18 AWG
Hülse für	1 mm ²

Connection data

Strip length	6 mm / 0.24 Inch
--------------	------------------

Geometrical Data

Length	6 mm
Diameter	2.5 mm
Diameter 2	1.4 mm

Material Data

Weight	0.042 g
--------	---------

Commercial data

Country of origin	DE
GTIN	4017332277648
Customs Tariff No.	85369010000
Product Group	2 (Terminal Block Accessories)

Downloads

Documentation

Bid Text

216-123	Oct 10, 2017	DOC 25.1 kB	Download
---------	--------------	----------------	----------



Subject to changes.

WAGO Kontakttechnik GmbH & Co. KG
Hansastr. 27
32423 Minden
Phone: +49571 887-0 | Fax: +49571 887-169
Email: info.de@wago.com | Web: www.wago.com

Do you have any questions about our products?
We are always happy to take your call at +49 (571) 887-44222.