

Data sheet | Item number: 216-132

Ferrule; Sleeve for 0.34 mm² / AWG 24; uninsulated; electro-tin plated

www.wago.com/216-132

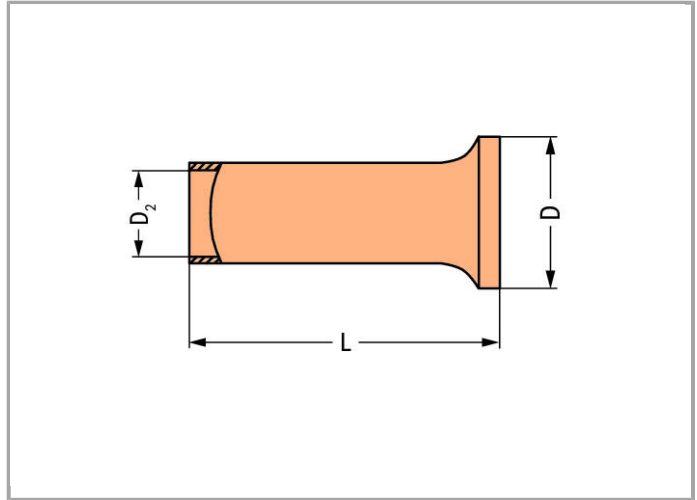

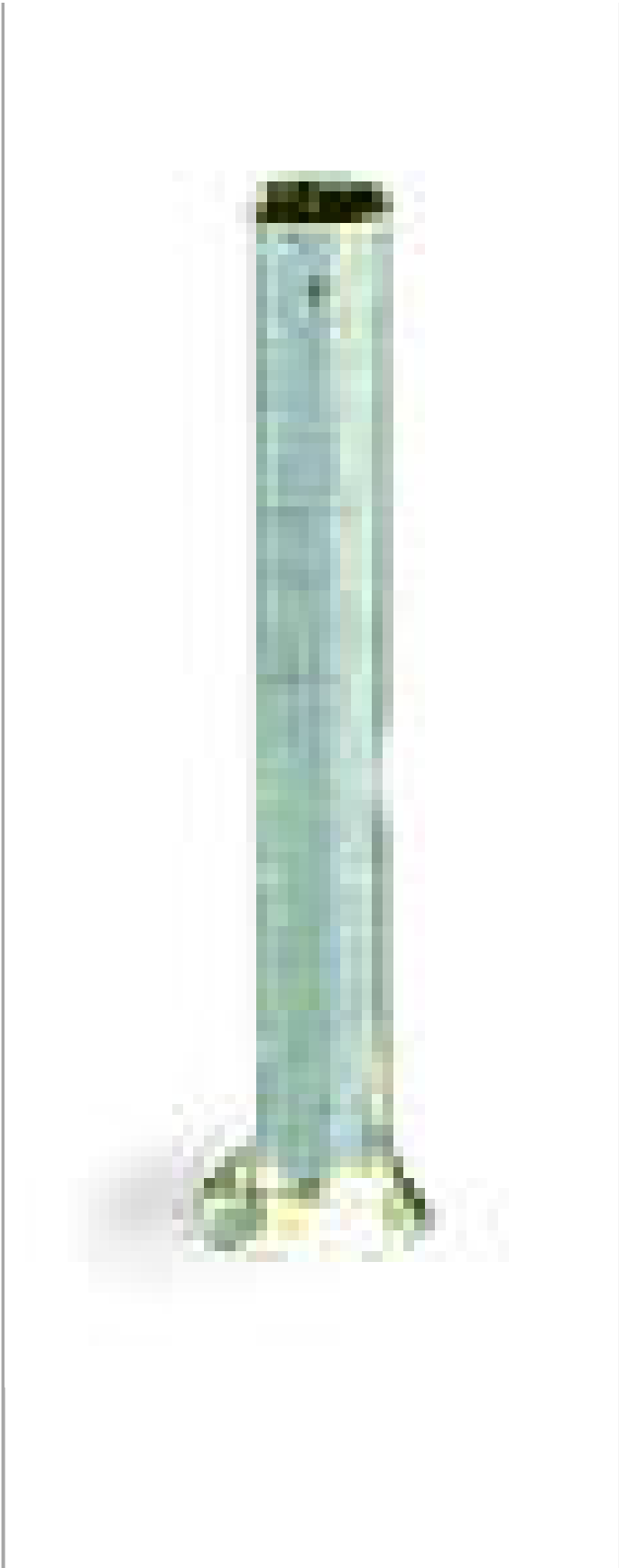

RoHS 
Compliant

[BOMcheck.net](https://www.bomcheck.net)

Data

Technical Data

Main product function	Ferrule
Querschnitt Hülse AWG	22 AWG
Hülse für	0.34 mm ²

Connection data

Strip length	7 mm / 0.28 Inch
--------------	------------------

Geometrical Data

Length	7 mm
Diameter	1.8 mm
Diameter 2	0.85 mm

Material Data

Weight	0.034 g
--------	---------

Commercial data

Country of origin	DE
GTIN	4017332277594
Customs Tariff No.	85369010000
Product Group	2 (Terminal Block Accessories)

Downloads

Documentation

Bid Text

216-132	Oct 10, 2017	DOC 24.6 kB	Download
---------	--------------	----------------	----------



Subject to changes.

WAGO Kontakttechnik GmbH & Co. KG
Hansastr. 27
32423 Minden
Phone: +49571 887-0 | Fax: +49571 887-169
Email: info.de@wago.com | Web: www.wago.com

Do you have any questions about our products?
We are always happy to take your call at +49 (571) 887-44222.