

Data sheet | Item number: 226-102

Feedthrough terminal block; Wire-wrap pin 1 x 1 mm; 1-pole; for plate thickness 1.5 mm

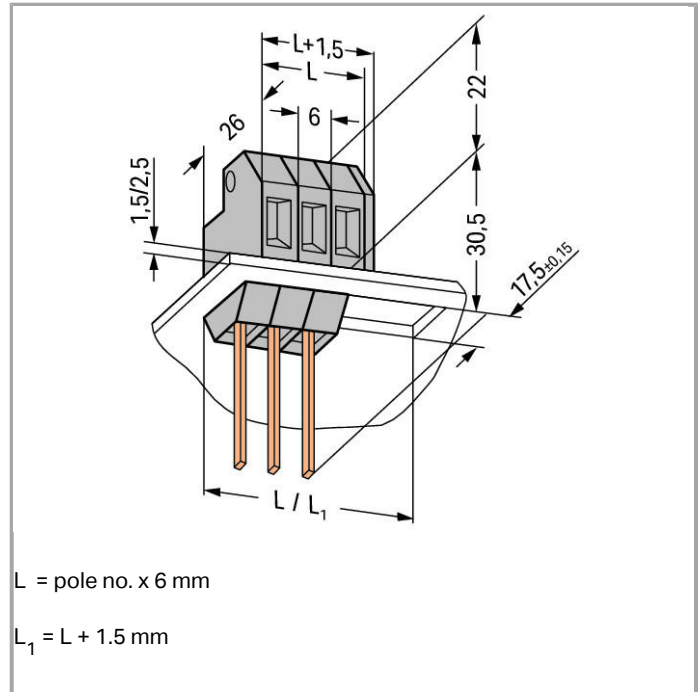

www.wago.com/226-102



Item description

- Modular feedthrough terminal blocks with screwdriver-actuated CAGE CLAMP®
- Tool-free insertion into sheet metal cutout
- Conductor entry parallel to enclosure wall saves space

Data

Electrical data

Ratings per IEC/EN 60664-1

| Ratings note | Wire-wrap pin |
|---------------------------------|---|
| Rated voltage (III / 3) | 320 V |
| Rated impulse voltage (III / 3) | 4 kV |
| Rated voltage (III / 2) | 320 V |
| Rated impulse voltage (III / 2) | 4 kV |
| Rated voltage (II / 2) | 630 V |
| Rated impulse voltage (II / 2) | 4 kV |
| Rated current | 4 A |
| Legend (ratings) | (III / 2) ≙ Overvoltage category III / Pollution degree 2 |

Approvals per UL 1059

| | |
|--------------------------------|-------|
| Rated voltage UL (Use Group B) | 300 V |
| Rated current UL (Use Group B) | 4 A |
| Rated voltage UL (Use Group C) | 300 V |
| Rated current UL (Use Group C) | 4 A |
| Rated voltage UL (Use Group D) | 600 V |
| Rated current UL (Use Group D) | 4 A |

Approvals per CSA

| | |
|---------------------------------|-------|
| Rated voltage CSA (Use Group B) | 300 V |
| Rated current CSA (Use Group B) | 4 A |
| Rated voltage CSA (Use Group C) | 300 V |
| Rated current CSA (Use Group C) | 4 A |
| Rated voltage CSA (Use Group D) | 600 V |
| Rated current CSA (Use Group D) | 4 A |

Connection data

| | |
|---|-------------|
| Connection technology | CAGE CLAMP® |
| Number of connection points (connection type) | 1 |



| | |
|---|--|
| Actuation type | Operating tool |
| Solid conductor | 0.08 ... 4 mm ² / 28 ... 12 AWG |
| Fine-stranded conductor | 0.08 ... 4 mm ² / 28 ... 12 AWG |
| Fine-stranded conductor with ferrule with plastic collar | 0.25 ... 2.5 mm ² |
| Fine-stranded conductor with ferrule without plastic collar | 0.25 ... 2.5 mm ² |
| Strip length | 9 ... 10 mm / 0.35 ... 0.39 Inch |
| Connection technology 2 | Wire-wrap pin |
| Number of connection points | 1 |
| No. of poles | 1 |
| Total number of connection points | 1 |
| Total number of potentials | 1 |
| Number of connection types | 2 |
| Number of levels | 1 |

Geometrical Data

| | |
|-------------------------|----------------------|
| Pin spacing | 6 mm (0.236 inch) |
| Width | 6 mm / 0.236 inch |
| Height | 38.5 mm / 1.516 inch |
| Height from the surface | 22 mm / 0.866 inch |
| Depth | 26 mm / 1.024 inch |

Mechanical data

| | |
|--------------------|---------------------------------------|
| Gehäuseblechstärke | 1.5 ... 1.5 mm / 0.059 ... 0.059 inch |
| Mounting type | Snap-in mounting foot |
| Type of mounting | Feed-through mounting |

Material Data

| | |
|-----------------------------|-----------------------------------|
| Color | gray |
| Material group | I |
| Insulating material | Polyamide 66 (PA 66) |
| Flammability class per UL94 | V0 |
| Clamping spring material | Chrome nickel spring steel (CrNi) |
| Contact material | Electrolytic copper (Ecu) |
| Contact plating | tin-plated |
| Weight | 3.407 g |

Environmental Requirements

| | |
|-------------------------|-----------------|
| Limit temperature range | -60 ... +105 °C |
|-------------------------|-----------------|

Commercial data

| | |
|--------------------|---------------------|
| Packaging type | bag |
| Country of origin | DE |
| GTIN | 4045454071677 |
| Customs Tariff No. | 85369010000 |
| Product Group | 4 (Printed Circuit) |

Approvals / Certificates

Country specific Approvals

| Logo | Approval | Certificate name |
|--|---------------------------------|------------------|
|  | CSA DEKRA Certification B.V. | 70010891 |

Ship Approvals





| Logo | Approval | Certificate name |
|---|---------------------------|------------------|
|  | BV Bureau Veritas S.A. | 07436/E0 BV |



UL-Approvals

| Logo | Approval | Certificate name |
|--|-------------------------------------|------------------|
|  | UL UL International Germany GmbH | E45172 |

Compatible products

ferrule

| | | |
|--|--|--|
|  | Item no.: 216-106 Ferrule; Sleeve for 2.5 mm ² / AWG 14; uninsulated; electro-tin plated | www.wago.com/216-106 |
|  | Item no.: 216-141 Ferrule; Sleeve for 0.5 mm ² / AWG 22; uninsulated; electro-tin plated; electrolytic copper; gastight crimped; acc. to DIN 46228, Part 1/08.92 | www.wago.com/216-141 |
|  | Item no.: 216-142 Ferrule; Sleeve for 0.75 mm ² / AWG 20; uninsulated; electro-tin plated; electrolytic copper; gastight crimped; acc. to DIN 46228, Part 1/08.92 | www.wago.com/216-142 |
|  | Item no.: 216-143 Ferrule; Sleeve for 1 mm ² / AWG 18; uninsulated; electro-tin plated; electrolytic copper; gastight crimped; acc. to DIN 46228, Part 1/08.92 | www.wago.com/216-143 |
| | Item no.: 216-144 | |

| | | |
|--|--|--|
|  | Ferrule; Sleeve for 1.5 mm ² / AWG 16; uninsulated; electro-tin plated; electrolytic copper; gastight crimped; acc. to DIN 46228, Part 1/08.92 | www.wago.com/216-144 |
|  | Item no.: 216-241 Ferrule; Sleeve for 0.5 mm ² / AWG 22; insulated; electro-tin plated; electrolytic copper; gastight crimped; acc. to DIN 46228, Part 4/09.90 | www.wago.com/216-241 |
|  | Item no.: 216-242 Ferrule; Sleeve for 0.75 mm ² / AWG 20; insulated; electro-tin plated; electrolytic copper; gastight crimped; acc. to DIN 46228, Part 4/09.90 | www.wago.com/216-242 |
|  | Item no.: 216-243 Ferrule; Sleeve for 1 mm ² / AWG 18; insulated; electro-tin plated; electrolytic copper; gastight crimped; acc. to DIN 46228, Part 4/09.90 | www.wago.com/216-243 |
|  | Item no.: 216-244 Ferrule; Sleeve for 1.5 mm ² / AWG 16; insulated; electro-tin plated; electrolytic copper; gastight crimped; acc. to DIN 46228, Part 4/09.90 | www.wago.com/216-244 |
|  | Item no.: 216-246 Ferrule; Sleeve for 2.5 mm ² / AWG 14; insulated; electro-tin plated; electrolytic copper; gastight crimped; acc. to DIN 46228, Part 4/09.90 | www.wago.com/216-246 |
|  | Item no.: 216-262 Ferrule; Sleeve for 0.75 mm ² / AWG 20; insulated; electro-tin plated; electrolytic copper; gastight crimped; acc. to DIN 46228, Part 4/09.90 | www.wago.com/216-262 |
|  | Item no.: 216-263 Ferrule; Sleeve for 1 mm ² / AWG 18; insulated; electro-tin plated; electrolytic copper; gastight crimped; acc. to DIN 46228, Part 4/09.90 | www.wago.com/216-263 |
|  | Item no.: 216-264 Ferrule; Sleeve for 1.5 mm ² / AWG 16; insulated; electro-tin plated; electrolytic copper; gastight crimped; acc. to DIN 46228, Part 4/09.90 | www.wago.com/216-264 |
|  | Item no.: 216-266 Ferrule; Sleeve for 2.5 mm ² / AWG 14; insulated; electro-tin plated; electrolytic copper; gastight crimped; acc. to DIN 46228, Part 4/09.90 | www.wago.com/216-266 |
|  | Item no.: 216-284 Ferrule; Sleeve for 1.5 mm ² / AWG 16; insulated; electro-tin plated; electrolytic copper; gastight crimped; acc. to DIN 46228, Part 4/09.90 | www.wago.com/216-284 |
|  | Item no.: 216-286 Ferrule; Sleeve for 2.5 mm ² / AWG 14; insulated; electro-tin plated; electrolytic copper; gastight crimped; acc. to DIN 46228, Part 4/09.90 | www.wago.com/216-286 |

General accessories

| | | |
|--|---|--|
|  | Item no.: 226-109 Spacer; for plate thickness 1.5 mm; 6 mm wide | www.wago.com/226-109 |
|  | Item no.: 226-119 Spacer; for plate thickness 2.5 mm; 6 mm wide | www.wago.com/226-119 |

check

| | | |
|--|--|--|
|  | Item no.: 210-136 Test plug; 2 mm Ø; with 500 mm cable | www.wago.com/210-136 |
|--|--|--|

tools

| | | |
|--|--|--|
|  | Item no.: 210-657 Operating tool with partially insulated shaft; Blade (3.5 x 0.5) mm; short | www.wago.com/210-657 |
|--|--|--|



Item no.: 210-720

Operating tool with partially insulated shaft; Type 2, blade (3.5 x 0.5) mm

www.wago.com/210-720

End plate



Item no.: 226-110

End plate; for 630 V, cut-out dimensions L1; 1.5 mm thick

www.wago.com/226-110



Item no.: 226-120

End plate; for 400 V, cut-out dimensions L1; 1.5 mm thick

www.wago.com/226-120

Subject to changes.

WAGO Kontakttechnik GmbH & Co. KG

Hansastr. 27

32423 Minden

Phone: +49571 887-0 | Fax: +49571 887-169

Email: info.de@wago.com | Web: www.wago.com

Do you have any questions about our products?

We are always happy to take your call at +49 (571) 887-44222.