

RoHS Compliant

Color:

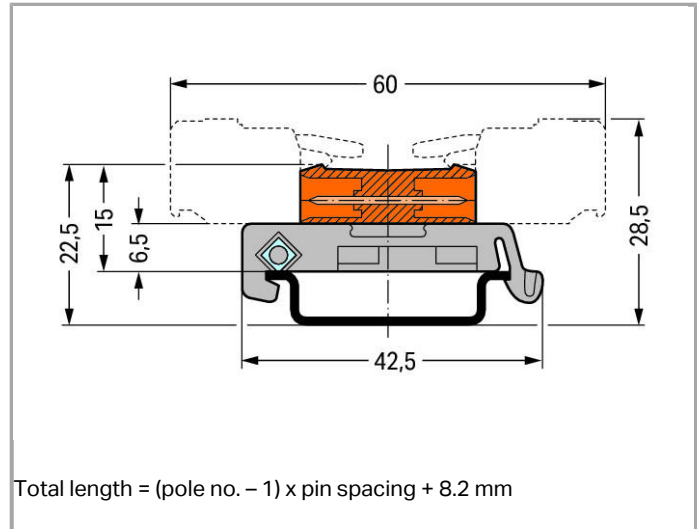

Item description

- Allow MCS Female Connectors fitted with wire harness or cable assembly to be plugged together
- Adapter for DIN-35 rail mounting
- Coding via coding keys on both sides

Other variants can be requested via the WAGO sales department or, if necessary, configured at <https://configurator.wago.com/>: Other pole numbers

Data

Electrical data

Ratings per IEC/EN 60664-1

Ratings note	Notice: Male connectors shall not be live when disconnected!
Rated voltage (III / 3)	500 V
Rated impulse voltage (III / 3)	6 kV
Rated voltage (III / 2)	630 V
Rated impulse voltage (III / 2)	6 kV



Rated voltage (II / 2)	1000 V
Rated impulse voltage (II / 2)	6 kV
Rated current	12 A
Legend (ratings)	(III / 2) \triangleq Overvoltage category III / Pollution degree 2

Approvals per UL 1059

Rated voltage UL (Use Group B)	300 V
Rated current UL (Use Group B)	15 A
Rated voltage UL (Use Group D)	300 V
Rated current UL (Use Group D)	10 A

Approvals per CSA

Rated voltage CSA (Use Group B)	300 V
Rated current CSA (Use Group B)	15 A
Rated voltage CSA (Use Group D)	300 V
Rated current CSA (Use Group D)	10 A

Connection data

No. of poles	2
Total number of potentials	2
Number of levels	1

Geometrical Data

Pin spacing	7.62 mm (0.3 inch)
Width	15.62 mm / 0.615 inch
Height from upper-edge of DIN-35 rail	15 mm / 0.591 inch
Depth	42.5 mm / 1.673 inch

Mechanical data

Type of mounting	DIN-35 rail
------------------	-------------

Plug connection

Contact type (pluggable connector)	Male connector/plug
Connector connection type	for pluggable connectors
Mismating protection	No

Material Data

Color	orange
Material group	I

Insulating material	Polyamide 66 (PA 66)
Flammability class per UL94	V0
Contact material	Electrolytic copper (Ecu)
Contact plating	tin-plated
Fire load	0.128 MJ
Weight	4.888 g

Environmental Requirements

Limit temperature range	-60 ... +100 °C
-------------------------	-----------------

Commercial data



Country of origin	DE
GTIN	4045454340483
Customs Tariff No.	85366990990
Product Group	3 (Multi Conn. System)

Approvals / Certificates



Country specific Approvals

Logo	Approval	Certificate name
	KEMA/KEUR DEKRA Certification B.V.	2190761.01

Ship Approvals

Logo	Approval	Certificate name
	ABS American Bureau of Shipping	14-HG1241537-PDA
	DNV GL Det Norske Veritas, Germanischer Lloyd	TAE000016Z

UL-Approvals

Logo	Approval	Certificate name
	UR Underwriters Laboratories Inc.	E45172
	UR Underwriters Laboratories Inc.	E45171



Compatible products

Coding



Item no.: 231-130
Coding key; snap-on type

www.wago.com/231-130

Marking accessories



Item no.: 210-833
Marking strips; on reel; 6 mm wide; plain; Self-adhesive

www.wago.com/210-833



Item no.: 210-834
Marking strips; on reel; 5 mm wide; plain; Self-adhesive

www.wago.com/210-834

Carrier rail



Item no.: 210-112
Steel carrier rail; 35 x 7.5 mm; 1 mm thick; 2 m long; slotted; according to EN 60715; "Hole width 25 mm

www.wago.com/210-112

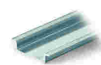

Item no.: 210-113
Steel carrier rail; 35 x 7.5 mm; 1 mm thick; 2 m long; unslotted; according to EN 60715

www.wago.com/210-113



Item no.: 210-114
Steel carrier rail; 35 x 15 mm; 1.5 mm thick; 2 m long; unslotted; similar to EN 60715

www.wago.com/210-114



Item no.: 210-115
Steel carrier rail; 35 x 7.5 mm; 1 mm thick; 2 m long; slotted; according to EN 60715; "Hole width 18 mm

www.wago.com/210-115



Item no.: 210-118
Steel carrier rail; 35 x 15 mm; 2.3 mm thick; 2 m long; unslotted; according to EN 60715

www.wago.com/210-118

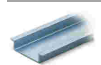

Item no.: 210-196
Aluminum carrier rail; 35 x 8.2 mm; 1.6 mm thick; 2 m long; unslotted; similar to EN 60715

www.wago.com/210-196



Item no.: 210-197
Steel carrier rail; 35 x 15 mm; 1.5 mm thick; 2 m long; slotted; similar to EN 60715

www.wago.com/210-197



Item no.: 210-198
Copper carrier rail; 35 x 15 mm; 2.3 mm thick; 2 m long; unslotted; according to EN 60715

www.wago.com/210-198



Item no.: 210-504
Steel carrier rail; 35 x 7.5 mm; 1 mm thick; 2 m long; slotted; galvanized; according to EN 60715

www.wago.com/210-504

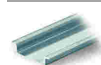

Item no.: 210-505
Steel carrier rail; 35 x 7.5 mm; 1 mm thick; 2 m long; unslotted; galvanized; according to EN 60715

www.wago.com/210-505



Item no.: 210-506
Steel carrier rail; 35 x 15 mm; 1.5 mm thick; 2 m long; unslotted; galvanized; similar to EN 60715

www.wago.com/210-506



Item no.: 210-508
Steel carrier rail; 35 x 15 mm; 1.5 mm thick; 2 m long; slotted; galvanized; similar to EN 60715

www.wago.com/210-508



Subject to changes.

WAGO Kontakttechnik GmbH & Co. KG
Hansastr. 27
32423 Minden
Phone: +49571 887-0 | Fax: +49571 887-169
Email: info.de@wago.com | Web: www.wago.com

Do you have any questions about our products?
We are always happy to take your call at +49 (571) 887-44222.