

## Data sheet | Item number: 233-148

PCB terminal block; 0.5 mm<sup>2</sup>; Pin spacing 2.5 mm; 48-pole; CAGE CLAMP®

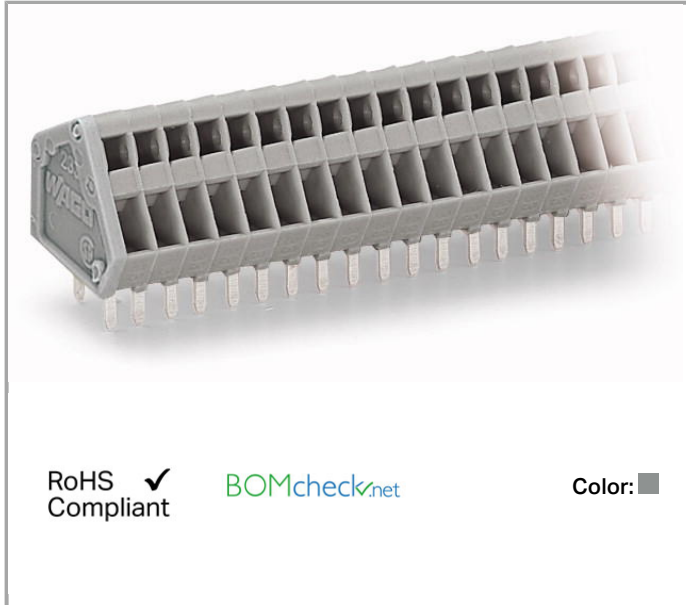

[www.wago.com/233-148](http://www.wago.com/233-148)



RoHS Compliant

Color:

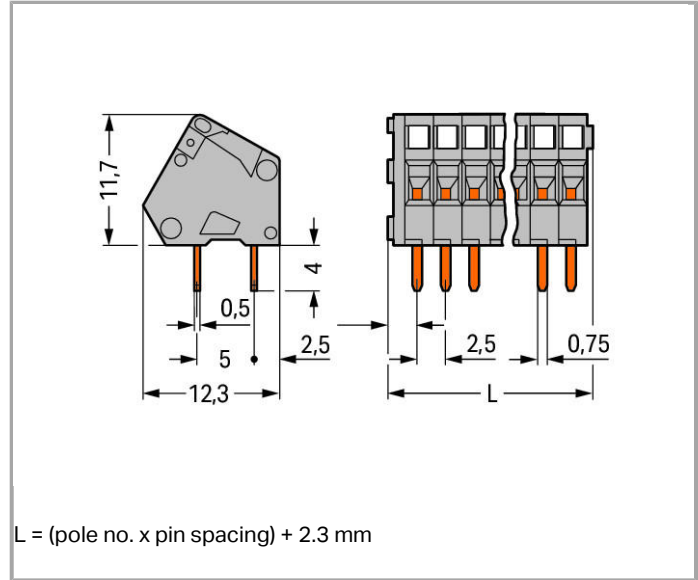

### Item description

- Compact terminal strips with CAGE CLAMP® connection and screwdriver actuation parallel or perpendicular to conductor entry
- Double solder pins for high mechanical stability
- Custom color combinations

Other variants can be requested via the WAGO sales department or, if necessary, configured at <https://configurator.wago.com/>: Direct marking, Mixed-color terminal strips, Other colors, Other pole numbers

### Data

#### Electrical data

#### Ratings per IEC/EN 60664-1

Rated voltage (III / 3)	63 V
Rated impulse voltage (III / 3)	2.5 kV
Rated voltage (III / 2)	160 V
Rated impulse voltage (III / 2)	2.5 kV
Rated voltage (II / 2)	320 V
Rated impulse voltage (II / 2)	2.5 kV
Rated current	6 A
Legend (ratings)	(III / 2) $\hat{=}$ Overvoltage category III / Pollution degree 2



### Approvals per UL 1059

Rated voltage UL (Use Group B)	150 V
Rated current UL (Use Group B)	4 A

### Approvals per CSA

Rated voltage CSA (Use Group B)	150 V
Rated current CSA (Use Group B)	4 A

### Connection data

Connection technology	CAGE CLAMP®
Actuation type	Operating tool
Solid conductor	0.08 ... 0.5 mm <sup>2</sup> / 28 ... 20 AWG
Fine-stranded conductor	0.08 ... 0.5 mm <sup>2</sup> / 28 ... 20 AWG
Fine-stranded conductor with ferrule with plastic collar	0.25 mm <sup>2</sup>
Fine-stranded conductor with ferrule without plastic collar	0.25 mm <sup>2</sup>
Strip length	5 ... 6 mm / 0.2 ... 0.24 Inch
Conductor entry angle to the PCB	30°
No. of poles	48
Total number of connection points	48
Total number of potentials	48
Number of connection types	1
Number of levels	1

### Geometrical Data

Pin spacing	2.5 mm (0.098 inch)
Width	122.3 mm / 4.815 inch
Height	15.7 mm / 0.618 inch
Height from the surface	11.7 mm / 0.461 inch
Depth	12.1 mm / 0.476 inch
Solder pin length	4 mm
Solder pin dimensions	0.5 x 0.75 mm
Drilled hole diameter (tolerance)	1.1 <sup>(+0.1)</sup> mm

### PCB contact

PCB contact	THT
Solder pin arrangement	over the entire terminal strip, in line
Number of solder pins per potential	2

## Material Data

Color	gray
Material group	I
Insulating material	Polyamide 66 (PA 66)
Flammability class per UL94	V0
Clamping spring material	Chrome nickel spring steel (CrNi)
Contact material	Electrolytic copper (Ecu)
Contact plating	tin-plated
Fire load	0.196 MJ
Weight	16.11 g

## Environmental Requirements

Limit temperature range	-60 ... +105 °C
-------------------------	-----------------

## Commercial data

Country of origin	CH
GTIN	4045454050818
Customs Tariff No.	85369010000
Product Group	4 (Printed Circuit)

## Approvals / Certificates

### Country specific Approvals

Logo	Approval	Certificate name
	CCA DEKRA Certification B.V.	NTR NL 6946
	CCA DEKRA Certification B.V.	2153951.01
	CSA DEKRA Certification B.V.	1465035
	CSA DEKRA Certification B.V.	1465035

### Ship Approvals

Logo	Approval	Certificate name



**DNV GL**  
Det Norske Veritas, Germanischer Lloyd







TAE000016Z

### UL-Approvals





Logo	Approval	Certificate name
	UL UL International Germany GmbH	E45172

### Compatible products

#### tools

	<b>Item no.: 210-647</b> Operating tool with partially insulated shaft; Blade (2.5 x 0.4) mm; short	<a href="http://www.wago.com/210-647">www.wago.com/210-647</a>
	<b>Item no.: 210-648</b> Operating tool with partially insulated shaft; Blade (2.5 x 0.4) mm; short; angled	<a href="http://www.wago.com/210-648">www.wago.com/210-648</a>
	<b>Item no.: 210-719</b> Operating tool with partially insulated shaft; Type 1, blade (2.5 x 0.4) mm	<a href="http://www.wago.com/210-719">www.wago.com/210-719</a>
	<b>Item no.: 233-331</b> Operating tool; for female and male connectors with CAGE CLAMP® connection; insulated	<a href="http://www.wago.com/233-331">www.wago.com/233-331</a>
	<b>Item no.: 233-332</b> Operating tool; for 233 and 733 Series; of insulating material	<a href="http://www.wago.com/233-332">www.wago.com/233-332</a>
	<b>Item no.: 233-335</b> Operating tool; for 233 and 733 Series	<a href="http://www.wago.com/233-335">www.wago.com/233-335</a>







#### ferrule

	<b>Item no.: 216-131</b> Ferrule; Sleeve for 0.25 mm <sup>2</sup> / AWG 24; uninsulated; electro-tin plated	<a href="http://www.wago.com/216-131">www.wago.com/216-131</a>
	<b>Item no.: 216-151</b> Ferrule; Sleeve for 0.25 mm <sup>2</sup> / AWG 24; uninsulated; electro-tin plated	<a href="http://www.wago.com/216-151">www.wago.com/216-151</a>
	<b>Item no.: 216-301</b> Ferrule; Sleeve for 0.25 mm <sup>2</sup> / AWG 24; insulated; electro-tin plated	<a href="http://www.wago.com/216-301">www.wago.com/216-301</a>
	<b>Item no.: 216-321</b> Ferrule; Sleeve for 0.25 mm <sup>2</sup> / AWG 24; insulated; electro-tin plated	<a href="http://www.wago.com/216-321">www.wago.com/216-321</a>

#### Marking accessories

	<b>Item no.: 210-331/250-202</b> Marking strips; as a DIN A4 sheet; MARKED; 1-16 (400x); Height of marker strip: 2.3 mm/0.091 in; Strip length 182 mm; Horizontal marking; Self-adhesive	<a href="http://www.wago.com/210-331/250-202">www.wago.com/210-331/250-202</a>
--	---	--



	<b>Item no.: 210-331/250-204</b> Marking strips; as a DIN A4 sheet; MARKED; 17-32 (400x); Height of marker strip: 2.3 mm/0.091 in; Strip length 182 mm; Horizontal marking; Self-adhesive	<a href="http://www.wago.com/210-331/250-204">www.wago.com/210-331/250-204</a>
	<b>Item no.: 210-331/250-206</b> Marking strips; as a DIN A4 sheet; MARKED; 33-48 (400x); Height of marker strip: 2.3 mm/0.091 in; Strip length 182 mm; Horizontal marking; Self-adhesive	<a href="http://www.wago.com/210-331/250-206">www.wago.com/210-331/250-206</a>
	<b>Item no.: 210-331/250-207</b> Marking strips; as a DIN A4 sheet; MARKED; 1-48 (100x); Height of marker strip: 2.3 mm/0.091 in; Strip length 182 mm; Horizontal marking; Self-adhesive	<a href="http://www.wago.com/210-331/250-207">www.wago.com/210-331/250-207</a>
	<b>Item no.: 210-331/254-202</b> Marking strips; as a DIN A4 sheet; MARKED; 1-16 (400x); Height of marker strip: 2.3 mm/0.091 in; Strip length 182 mm; Horizontal marking; Self-adhesive	<a href="http://www.wago.com/210-331/254-202">www.wago.com/210-331/254-202</a>
	<b>Item no.: 210-331/254-204</b> Marking strips; as a DIN A4 sheet; MARKED; 17-32 (400x); Height of marker strip: 2.3 mm/0.091 in; Strip length 182 mm; Horizontal marking; Self-adhesive	<a href="http://www.wago.com/210-331/254-204">www.wago.com/210-331/254-204</a>
	<b>Item no.: 210-331/254-206</b> Marking strips; as a DIN A4 sheet; MARKED; 33-48 (400x); Height of marker strip: 2.3 mm/0.091 in; Strip length 182 mm; Horizontal marking; Self-adhesive	<a href="http://www.wago.com/210-331/254-206">www.wago.com/210-331/254-206</a>
	<b>Item no.: 210-331/254-207</b> Marking strips; as a DIN A4 sheet; MARKED; 1-48 (100x); Height of marker strip: 2.3 mm/0.091 in; Strip length 182 mm; Horizontal marking; Self-adhesive	<a href="http://www.wago.com/210-331/254-207">www.wago.com/210-331/254-207</a>

## Downloads

### smartDATA

#### CAD data

3D Download 233-148	URL	Download
---------------------	-----	----------

#### PCB libraries

EAGLE Library for WAGO PCB Terminal Blocks Compatible with EAGLE PCB Design Software Version 6.x or higher	2.1 Nov 17, 2017	ZIP 23.9 MB	Download
DesignSpark Library for WAGO PCB Terminal Blocks Compatible with DesignSpark PCB Version 4.x or higher	2.1 Oct 6, 2014	ZIP 22.5 MB	Download
TARGET Library for WAGO PCB Terminal Blocks Compatible with TARGET PCB Design Software Version 17.x	1.1.0 Oct 6, 2014	ZIP 27.1 MB	Download



Subject to changes.

---

WAGO Kontakttechnik GmbH & Co. KG  
Hansastr. 27  
32423 Minden  
Phone: +49571 887-0 | Fax: +49571 887-169  
Email: [info.de@wago.com](mailto:info.de@wago.com) | Web: [www.wago.com](http://www.wago.com)

Do you have any questions about our products?  
We are always happy to take your call at +49 (571) 887-44222.