

Data sheet | Item number: 235-712

Stackable 2-conductor PCB terminal block; 0.75 mm²; Pin spacing 5/5.08 mm; 1-pole; PUSH WIRE®

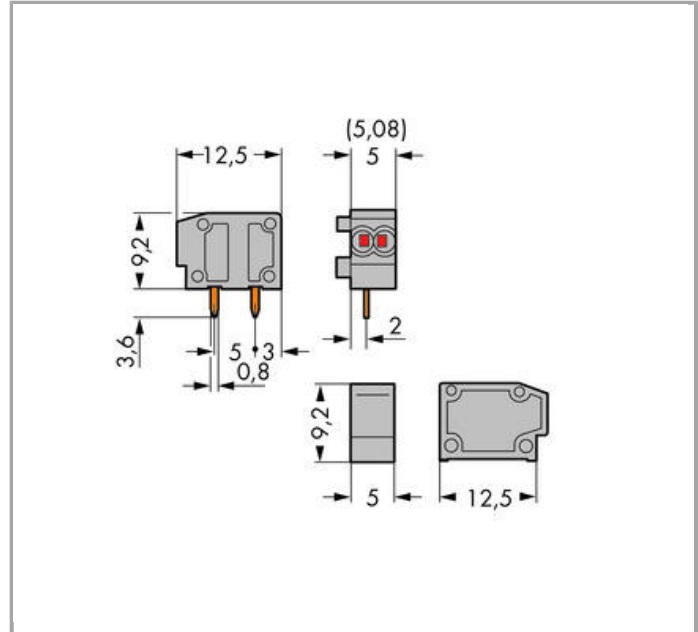

www.wago.com/235-712



RoHS Compliant

[BOMcheck.net](https://www.bomcheck.net)

Color: ■

Item description

- Low-profile modular terminal blocks with screwdriver-actuated PUSH WIRE® termination for custom terminal strip assemblies
- Double-conductor connection for supply and distribution of signals – ideal for standard, single-conductor signal lines – suitable for push-in termination
- Double solder pins for high mechanical stability
- Combines with all 235 Series modular terminal blocks
- Set to metric or inch pin spacing by compressing terminal strips together or pulling them apart
- Conductor removal via screwdriver (2.5mm x 0.4mm)

Other variants can be requested via the WAGO sales department or, if necessary, configured at <https://configurator.wago.com/>: Other colors

Data

Electrical data

Ratings per IEC/EN 60664-1

| | |
|---------------------------------|--|
| Rated voltage (III / 3) | 250 V |
| Rated impulse voltage (III / 3) | 4 kV |
| Rated voltage (III / 2) | 320 V |
| Rated impulse voltage (III / 2) | 4 kV |
| Rated voltage (II / 2) | 630 V |
| Rated impulse voltage (II / 2) | 4 kV |
| Rated current | 10 A |
| Legend (ratings) | (III / 2) \triangleq Overvoltage category III / Pollution degree 2 |

Approvals per UL 1059

| | |
|--------------------------------|-------|
| Rated voltage UL (Use Group B) | 300 V |
| Rated current UL (Use Group B) | 10 A |
| Rated voltage UL (Use Group D) | 300 V |
| Rated current UL (Use Group D) | 10 A |

Approvals per CSA

| | |
|---------------------------------|-------|
| Rated voltage CSA (Use Group B) | 300 V |
| Rated current CSA (Use Group B) | 10 A |

Connection data

| | |
|---|---|
| Connection technology | PUSH WIRE [®] |
| Actuation type | Operating tool |
| Solid conductor | 0.25 ... 0.75 mm ² / 24 ... 18 AWG |
| Fine-stranded conductor with ferrule without plastic collar | 0.25 ... 0.34 mm ² |
| Strip length | 9 ... 10 mm / 0.35 ... 0.39 Inch |
| Conductor entry angle to the PCB | 0° |
| No. of poles | 1 |
| Total number of connection points | 2 |
| Total number of potentials | 1 |
| Number of connection types | 1 |
| Number of levels | 1 |

Geometrical Data

| | |
|-------------|----------------------------|
| Pin spacing | 5/5.08 mm / 0.197/0.2 inch |
| Width | 6.5 mm / 0.256 inch |



| | |
|-----------------------------------|------------------------|
| Height | 12.8 mm / 0.504 inch |
| Height from the surface | 9.2 mm / 0.362 inch |
| Depth | 12.5 mm / 0.492 inch |
| Solder pin length | 3.6 mm |
| Solder pin dimensions | 0.8 x 0.4 mm |
| Drilled hole diameter (tolerance) | 1 ^(+0.1) mm |

PCB contact

| | |
|-------------------------------------|------------------------------------|
| PCB contact | THT |
| Solder pin arrangement | within the terminal block, in line |
| Number of solder pins per potential | 2 |

Material Data

| | |
|-----------------------------|-----------------------------------|
| Color | dark gray |
| Material group | I |
| Insulating material | Polyamide 66 (PA 66) |
| Flammability class per UL94 | V0 |
| Clamping spring material | Chrome nickel spring steel (CrNi) |
| Contact material | Electrolytic copper (Ecu) |
| Contact plating | tin-plated |
| Fire load | 0.011 MJ |
| Weight | 0.69 g |

Environmental Requirements

| | |
|-------------------------|-----------------|
| Limit temperature range | -60 ... +105 °C |
|-------------------------|-----------------|

Commercial data

| | |
|--------------------|---------------------|
| Country of origin | CH |
| GTIN | 4044918831796 |
| Customs Tariff No. | 85369010000 |
| Product Group | 4 (Printed Circuit) |

Approvals / Certificates

Country specific Approvals

| Logo | Approval | Certificate name |
|--|---------------------------------|------------------|
|  | CCA DEKRA Certification B.V. | NTR NL-7144 |
| | CCA | 2149549.02 |

DEKRA Certification B.V.



| | | |
|--|--|-------------|
|  | CCA DEKRA Certification B.V. | NTR NL 6919 |
|  | CCA DEKRA Certification B.V. | NTR NL-7310 |
|  | CSA DEKRA Certification B.V. | 1673956 |
|  | VDE VDE Prüf- und Zertifizierungsinstitut | 40029328 |

Ship Approvals





| Logo | Approval | Certificate name |
|--|--|------------------|
|  | DNV GL Det Norske Veritas, Germanischer Lloyd | TAE000016Z |



















Compatible products



















End plate



| | | |
|--|---|--|
|  | Item no.: 235-200 End plate; snap-fit type; 1 mm thick | www.wago.com/235-200 |
|--|---|--|

ferrule

| | | |
|--|---|--|
|  | Item no.: 216-101 Ferrule; Sleeve for 0.5 mm ² / AWG 22; uninsulated; electro-tin plated | www.wago.com/216-101 |
|  | Item no.: 216-102 Ferrule; Sleeve for 0.75 mm ² / AWG 20; uninsulated; electro-tin plated | www.wago.com/216-102 |
|  | Item no.: 216-103 Ferrule; Sleeve for 1 mm ² / AWG 18; uninsulated; electro-tin plated | www.wago.com/216-103 |
|  | Item no.: 216-104 Ferrule; Sleeve for 1.5 mm ² / AWG 16; uninsulated; electro-tin plated | www.wago.com/216-104 |
|  | Item no.: 216-106 Ferrule; Sleeve for 2.5 mm ² / AWG 14; uninsulated; electro-tin plated | www.wago.com/216-106 |

| | | |
|--|--|--|
|  | Item no.: 216-107 Ferrule; Sleeve for 4 mm ² / AWG 12; uninsulated; electro-tin plated | www.wago.com/216-107 |
|  | Item no.: 216-108 Ferrule; Sleeve for 6 mm ² / AWG 10; uninsulated; electro-tin plated | www.wago.com/216-108 |
|  | Item no.: 216-109 Ferrule; Sleeve for 10 mm ² / AWG 8; uninsulated; electro-tin plated | www.wago.com/216-109 |
|  | Item no.: 216-110 Ferrule; Sleeve for 16 mm ² / AWG 6; uninsulated; electro-tin plated | www.wago.com/216-110 |
|  | Item no.: 216-121 Ferrule; Sleeve for 0.5 mm ² / AWG 22; uninsulated; electro-tin plated | www.wago.com/216-121 |
|  | Item no.: 216-122 Ferrule; Sleeve for 0.75 mm ² / AWG 20; uninsulated; electro-tin plated | www.wago.com/216-122 |
|  | Item no.: 216-123 Ferrule; Sleeve for 1 mm ² / AWG 18; uninsulated; electro-tin plated | www.wago.com/216-123 |
|  | Item no.: 216-124 Ferrule; Sleeve for 1.5 mm ² / AWG 16; uninsulated; electro-tin plated | www.wago.com/216-124 |
|  | Item no.: 216-131 Ferrule; Sleeve for 0.25 mm ² / AWG 24; uninsulated; electro-tin plated | www.wago.com/216-131 |
|  | Item no.: 216-132 Ferrule; Sleeve for 0.34 mm ² / AWG 24; uninsulated; electro-tin plated | www.wago.com/216-132 |
|  | Item no.: 216-141 Ferrule; Sleeve for 0.5 mm ² / AWG 22; uninsulated; electro-tin plated; electrolytic copper; gastight crimped; acc. to DIN 46228, Part 1/08.92 | www.wago.com/216-141 |
|  | Item no.: 216-142 Ferrule; Sleeve for 0.75 mm ² / AWG 20; uninsulated; electro-tin plated; electrolytic copper; gastight crimped; acc. to DIN 46228, Part 1/08.92 | www.wago.com/216-142 |
|  | Item no.: 216-143 Ferrule; Sleeve for 1 mm ² / AWG 18; uninsulated; electro-tin plated; electrolytic copper; gastight crimped; acc. to DIN 46228, Part 1/08.92 | www.wago.com/216-143 |
|  | Item no.: 216-144 Ferrule; Sleeve for 1.5 mm ² / AWG 16; uninsulated; electro-tin plated; electrolytic copper; gastight crimped; acc. to DIN 46228, Part 1/08.92 | www.wago.com/216-144 |
|  | Item no.: 216-151 Ferrule; Sleeve for 0.25 mm ² / AWG 24; uninsulated; electro-tin plated | www.wago.com/216-151 |
|  | Item no.: 216-152 Ferrule; Sleeve for 0.34 mm ² / AWG 24; uninsulated; electro-tin plated | www.wago.com/216-152 |
|  | Item no.: 216-201 Ferrule; Sleeve for 0.5 mm ² / AWG 22; insulated; electro-tin plated | www.wago.com/216-201 |
|  | Item no.: 216-202 Ferrule; Sleeve for 0.75 mm ² / AWG 20; insulated; electro-tin plated | www.wago.com/216-202 |
|  | Item no.: 216-203 Ferrule; Sleeve for 1 mm ² / AWG 18; insulated; electro-tin plated | www.wago.com/216-203 |
| | Item no.: 216-204 | |

| | | |
|--|--|--|
|  | Ferrule; Sleeve for 1.5 mm ² / AWG 16; insulated; electro-tin plated | www.wago.com/216-204 |
|  | Item no.: 216-205 Ferrule; Sleeve for 2.08 mm ² / AWG 14; insulated; electro-tin plated | www.wago.com/216-205 |
|  | Item no.: 216-206 Ferrule; Sleeve for 2.5 mm ² / AWG 14; insulated; electro-tin plated | www.wago.com/216-206 |
|  | Item no.: 216-207 Ferrule; Sleeve for 4 mm ² / AWG 12; insulated; electro-tin plated | www.wago.com/216-207 |
|  | Item no.: 216-208 Ferrule; Sleeve for 6 mm ² / AWG 10; insulated; electro-tin plated; electrolytic copper; gastight crimped; acc. to DIN 46228, Part 4/09.90 | www.wago.com/216-208 |
|  | Item no.: 216-209 Ferrule; Sleeve for 10 mm ² / AWG 8; insulated; electro-tin plated | www.wago.com/216-209 |
|  | Item no.: 216-210 Ferrule; Sleeve for 16 mm ² / AWG 6; insulated; electro-tin plated; electrolytic copper; gastight crimped; acc. to DIN 46228, Part 4/09.90 | www.wago.com/216-210 |
|  | Item no.: 216-221 Ferrule; Sleeve for 0.5 mm ² / AWG 22; insulated; electro-tin plated | www.wago.com/216-221 |
|  | Item no.: 216-222 Ferrule; Sleeve for 0.75 mm ² / AWG 20; insulated; electro-tin plated | www.wago.com/216-222 |
|  | Item no.: 216-223 Ferrule; Sleeve for 1 mm ² / AWG 18; insulated; electro-tin plated | www.wago.com/216-223 |
|  | Item no.: 216-224 Ferrule; Sleeve for 1.5 mm ² / AWG 16; insulated; electro-tin plated | www.wago.com/216-224 |
|  | Item no.: 216-241 Ferrule; Sleeve for 0.5 mm ² / AWG 22; insulated; electro-tin plated; electrolytic copper; gastight crimped; acc. to DIN 46228, Part 4/09.90 | www.wago.com/216-241 |
|  | Item no.: 216-242 Ferrule; Sleeve for 0.75 mm ² / AWG 20; insulated; electro-tin plated; electrolytic copper; gastight crimped; acc. to DIN 46228, Part 4/09.90 | www.wago.com/216-242 |
|  | Item no.: 216-243 Ferrule; Sleeve for 1 mm ² / AWG 18; insulated; electro-tin plated; electrolytic copper; gastight crimped; acc. to DIN 46228, Part 4/09.90 | www.wago.com/216-243 |
|  | Item no.: 216-244 Ferrule; Sleeve for 1.5 mm ² / AWG 16; insulated; electro-tin plated; electrolytic copper; gastight crimped; acc. to DIN 46228, Part 4/09.90 | www.wago.com/216-244 |
|  | Item no.: 216-246 Ferrule; Sleeve for 2.5 mm ² / AWG 14; insulated; electro-tin plated; electrolytic copper; gastight crimped; acc. to DIN 46228, Part 4/09.90 | www.wago.com/216-246 |
|  | Item no.: 216-262 Ferrule; Sleeve for 0.75 mm ² / AWG 20; insulated; electro-tin plated; electrolytic copper; gastight crimped; acc. to DIN 46228, Part 4/09.90 | www.wago.com/216-262 |
|  | Item no.: 216-263 Ferrule; Sleeve for 1 mm ² / AWG 18; insulated; electro-tin plated; electrolytic copper; gastight crimped; acc. to DIN 46228, Part 4/09.90 | www.wago.com/216-263 |
| | Item no.: 216-264 | |

| | | |
|--|---|--|
|  | Ferrule; Sleeve for 1.5 mm ² / AWG 16; insulated; electro-tin plated; electrolytic copper; gastight crimped; acc. to DIN 46228, Part 4/09.90 | www.wago.com/216-264 |
|  | Item no.: 216-266 Ferrule; Sleeve for 2.5 mm ² / AWG 14; insulated; electro-tin plated; electrolytic copper; gastight crimped; acc. to DIN 46228, Part 4/09.90 | www.wago.com/216-266 |
|  | Item no.: 216-267 Ferrule; Sleeve for 4 mm ² / AWG 12; insulated; electro-tin plated; electrolytic copper; gastight crimped; acc. to DIN 46228, Part 4/09.90 | www.wago.com/216-267 |
|  | Item no.: 216-284 Ferrule; Sleeve for 1.5 mm ² / AWG 16; insulated; electro-tin plated; electrolytic copper; gastight crimped; acc. to DIN 46228, Part 4/09.90 | www.wago.com/216-284 |
|  | Item no.: 216-286 Ferrule; Sleeve for 2.5 mm ² / AWG 14; insulated; electro-tin plated; electrolytic copper; gastight crimped; acc. to DIN 46228, Part 4/09.90 | www.wago.com/216-286 |
|  | Item no.: 216-287 Ferrule; Sleeve for 4 mm ² / AWG 12; insulated; electro-tin plated; electrolytic copper; gastight crimped; acc. to DIN 46228, Part 4/09.90 | www.wago.com/216-287 |
|  | Item no.: 216-288 Ferrule; Sleeve for 6 mm ² / AWG 10; insulated; electro-tin plated; electrolytic copper; gastight crimped; acc. to DIN 46228, Part 4/09.90 | www.wago.com/216-288 |
|  | Item no.: 216-289 Ferrule; Sleeve for 10 mm ² / AWG 8; insulated; electro-tin plated; electrolytic copper; gastight crimped; acc. to DIN 46228, Part 4/09.90 | www.wago.com/216-289 |
|  | Item no.: 216-301 Ferrule; Sleeve for 0.25 mm ² / AWG 24; insulated; electro-tin plated | www.wago.com/216-301 |
|  | Item no.: 216-302 Ferrule; Sleeve for 0.34 mm ² / AWG 24; insulated; electro-tin plated | www.wago.com/216-302 |
|  | Item no.: 216-321 Ferrule; Sleeve for 0.25 mm ² / AWG 24; insulated; electro-tin plated | www.wago.com/216-321 |
|  | Item no.: 216-322 Ferrule; Sleeve for 0.34 mm ² / AWG 24; insulated; electro-tin plated | www.wago.com/216-322 |

General accessories

| | | |
|--|--|--|
|  | Item no.: 235-701 Spacer; for doubling the pin spacing | www.wago.com/235-701 |
|--|--|--|

Downloads

smartDATA

CAD data

| | | |
|---------------------|-----|----------|
| 3D Download 235-712 | URL | Download |
|---------------------|-----|----------|

PCB libraries

| | | | |
|---|-------------|---------|----------|
| DesignSpark Library for WAGO PCB Terminal Blocks | 2.1 | ZIP | Download |
| Compatible with DesignSpark PCB Version 4.x or higher | Oct 6, 2014 | 22.5 MB | |



| | | | |
|---|----------------------|----------------|----------|
| EAGLE Library for WAGO PCB Terminal Blocks Compatible with EAGLE PCB Design Software Version 6.x or higher | 2.1 Nov 17, 2017 | ZIP 23.9 MB | Download |
| TARGET Library for WAGO PCB Terminal Blocks Compatible with TARGET PCB Design Software Version 17.x | 1.1.0 Oct 6, 2014 | ZIP 27.1 MB | Download |

Subject to changes.

WAGO Kontakttechnik GmbH & Co. KG
Hansastr. 27
32423 Minden
Phone: +49571 887-0 | Fax: +49571 887-169
Email: info.de@wago.com | Web: www.wago.com

Do you have any questions about our products?
We are always happy to take your call at +49 (571) 887-44222.