

Data sheet | Item number: 236-524/000-009/999-950

PCB terminal block; 2.5 mm²; Pin spacing 7.5/7.62 mm; 24-pole; suitable for Ex-e applications; CAGE CLAMP®; commoning option

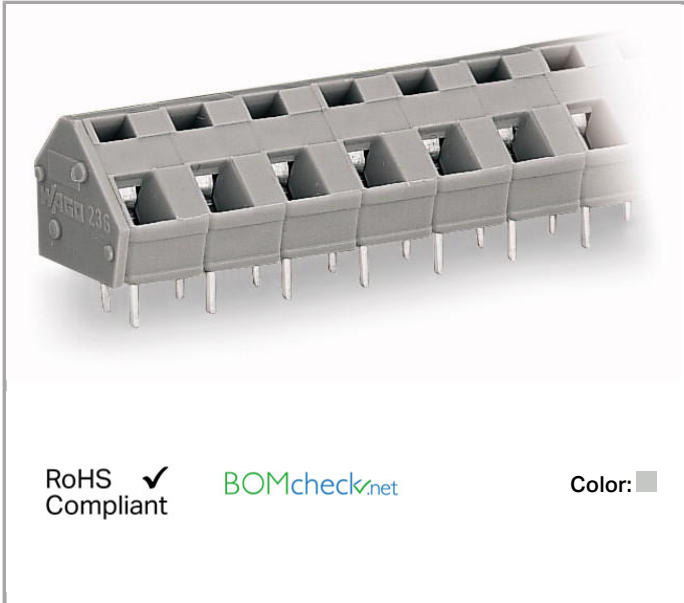

www.wago.com/236-524/000-009/999-950



RoHS
Compliant ✓

BOMcheck.net

Color: ■

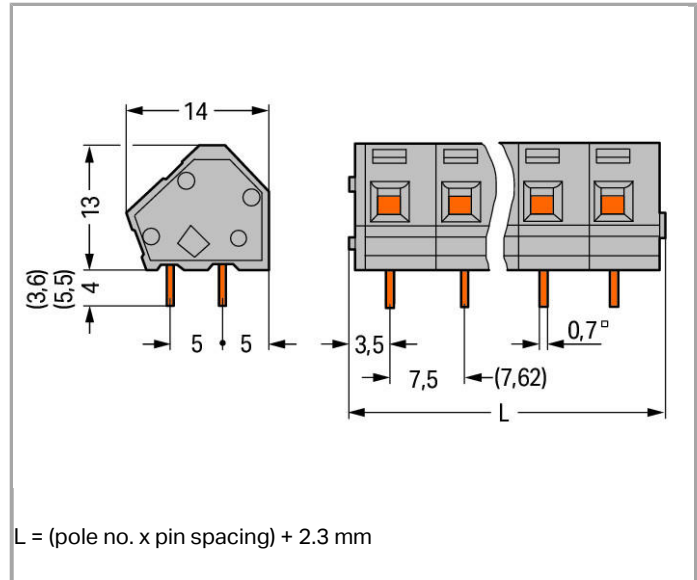

Item description

- PCB terminal strips with CAGE CLAMP® connection and screwdriver actuation parallel or perpendicular to conductor entry
- Operating tools for factory wiring
- 45° conductor entry angle permits a wide range of applications and wiring options
- Set to metric or inch pin spacing by compressing PCB terminal strips or pulling them apart

Other variants can be requested via the WAGO sales department or, if necessary, configured at <https://configurator.wago.com/>: Direct marking, Other pole numbers

Data

Electrical data

Rated voltage EN (Ex e II)	275 V
Rated current (Ex e II)	16 A

Connection data

Connection technology	CAGE CLAMP®
Actuation type	Operating tool
Solid conductor	0.08 ... 2.5 mm ² / 28 ... 12 AWG
Fine-stranded conductor	0.08 ... 2.5 mm ² / 28 ... 12 AWG
Fine-stranded conductor with ferrule with plastic collar	0.25 ... 1.5 mm ²



Fine-stranded conductor with ferrule without plastic collar	0.25 ... 1.5 mm ²
Strip length	5 ... 6 mm / 0.2 ... 0.24 Inch
Conductor entry angle to the PCB	45°
No. of poles	24
Total number of connection points	24
Total number of potentials	24
Number of connection types	1
Number of levels	1

Geometrical Data

Pin spacing	7.5/7.62 mm / 0.295/0.3 inch
Width	182.3 mm / 7.177 inch
Height	17 mm / 0.669 inch
Height from the surface	13 mm / 0.512 inch
Depth	14 mm / 0.551 inch
Solder pin length	4 mm
Solder pin dimensions	0.7 x 0.7 mm
Drilled hole diameter (tolerance)	1.1 ^(+0.1) mm

PCB contact

PCB contact	THT
Solder pin arrangement	over the entire terminal strip, in line
Number of solder pins per potential	2

Material Data

Color	light gray
Material group	I
Insulating material	Polyamide 66 (PA 66)
Flammability class per UL94	V0
Clamping spring material	Chrome nickel spring steel (CrNi)
Contact material	Electrolytic copper (Ecu)
Contact plating	tin-plated
Fire load	0.436 MJ
Weight	26.158 g

Environmental Requirements

Limit temperature range	-60 ... +105 °C
-------------------------	-----------------

Commercial data

Country of origin	CH
GTIN	4044918772983
Customs Tariff No.	85369010000
Product Group	4 (Printed Circuit)

Approvals / Certificates

Ex-Approvals



Logo	Approval	Certificate name
	ATEX Physikalisch Technische Bundesanstalt (PTB)	PTB 06 Atex 1061 U (II 2 G Ex ell bzw. I M2 Ex el)

Country specific Approvals



Logo	Approval	Certificate name
	CSA DEKRA Certification B.V.	1673957

Compatible products



check

	Item no.: 231-125 Testing plug module with contact stud; Pin spacing 7.62 mm / 0.3 in	www.wago.com/231-125
	Item no.: 231-161 Testing plug module with contact stud; for 236 Series; Pin spacing 7.5 mm / 0.295 in	www.wago.com/231-161

Marking accessories

	Item no.: 210-332/750-020 Marking strips; as a DIN A4 sheet; MARKED; 1-20 (80x); Height of marker strip: 3 mm; Strip length 182 mm; Horizontal marking; Self-adhesive	www.wago.com/210-332/750-020
	Item no.: 210-332/762-020 Marking strips; as a DIN A4 sheet; MARKED; 1-20 (80x); Height of marker strip: 3 mm; Strip length 182 mm; Horizontal marking; Self-adhesive	www.wago.com/210-332/762-020

tools

	Item no.: 210-657 Operating tool with partially insulated shaft; Blade (3.5 x 0.5) mm; short	www.wago.com/210-657
	Item no.: 210-658 Operating tool with partially insulated shaft; Blade (3.5 x 0.5) mm; short; angled	www.wago.com/210-658



Item no.: 210-720
Operating tool with partially insulated shaft; Type 2, blade (3.5 x 0.5) mm

www.wago.com/210-720



Item no.: 236-332
Operating tool; plastic

www.wago.com/236-332



Item no.: 236-335
Operating tool; metal

www.wago.com/236-335

ferrule



Item no.: 216-101
Ferrule; Sleeve for 0.5 mm² / AWG 22; uninsulated; electro-tin plated

www.wago.com/216-101



Item no.: 216-102
Ferrule; Sleeve for 0.75 mm² / AWG 20; uninsulated; electro-tin plated

www.wago.com/216-102



Item no.: 216-103
Ferrule; Sleeve for 1 mm² / AWG 18; uninsulated; electro-tin plated

www.wago.com/216-103



Item no.: 216-104
Ferrule; Sleeve for 1.5 mm² / AWG 16; uninsulated; electro-tin plated

www.wago.com/216-104



Item no.: 216-121
Ferrule; Sleeve for 0.5 mm² / AWG 22; uninsulated; electro-tin plated

www.wago.com/216-121



Item no.: 216-122
Ferrule; Sleeve for 0.75 mm² / AWG 20; uninsulated; electro-tin plated

www.wago.com/216-122



Item no.: 216-123
Ferrule; Sleeve for 1 mm² / AWG 18; uninsulated; electro-tin plated

www.wago.com/216-123



Item no.: 216-124
Ferrule; Sleeve for 1.5 mm² / AWG 16; uninsulated; electro-tin plated

www.wago.com/216-124



Item no.: 216-131
Ferrule; Sleeve for 0.25 mm² / AWG 24; uninsulated; electro-tin plated

www.wago.com/216-131



Item no.: 216-132
Ferrule; Sleeve for 0.34 mm² / AWG 24; uninsulated; electro-tin plated

www.wago.com/216-132



Item no.: 216-141
Ferrule; Sleeve for 0.5 mm² / AWG 22; uninsulated; electro-tin plated; electrolytic copper; gastight crimped; acc. to DIN 46228, Part 1/08.92

www.wago.com/216-141



Item no.: 216-142
Ferrule; Sleeve for 0.75 mm² / AWG 20; uninsulated; electro-tin plated; electrolytic copper; gastight crimped; acc. to DIN 46228, Part 1/08.92

www.wago.com/216-142



Item no.: 216-143
Ferrule; Sleeve for 1 mm² / AWG 18; uninsulated; electro-tin plated; electrolytic copper; gastight crimped; acc. to DIN 46228, Part 1/08.92

www.wago.com/216-143





















Item no.: 216-144
Ferrule; Sleeve for 1.5 mm² / AWG 16; uninsulated; electro-tin plated; electrolytic copper; gastight crimped; acc. to DIN 46228, Part 1/08.92

www.wago.com/216-144



Item no.: 216-151
Ferrule; Sleeve for 0.25 mm² / AWG 24; uninsulated; electro-tin plated

www.wago.com/216-151

	Item no.: 216-152 Ferrule; Sleeve for 0.34 mm ² / AWG 24; uninsulated; electro-tin plated	www.wago.com/216-152
	Item no.: 216-201 Ferrule; Sleeve for 0.5 mm ² / AWG 22; insulated; electro-tin plated	www.wago.com/216-201
	Item no.: 216-202 Ferrule; Sleeve for 0.75 mm ² / AWG 20; insulated; electro-tin plated	www.wago.com/216-202
	Item no.: 216-203 Ferrule; Sleeve for 1 mm ² / AWG 18; insulated; electro-tin plated	www.wago.com/216-203
	Item no.: 216-204 Ferrule; Sleeve for 1.5 mm ² / AWG 16; insulated; electro-tin plated	www.wago.com/216-204
	Item no.: 216-221 Ferrule; Sleeve for 0.5 mm ² / AWG 22; insulated; electro-tin plated	www.wago.com/216-221
	Item no.: 216-222 Ferrule; Sleeve for 0.75 mm ² / AWG 20; insulated; electro-tin plated	www.wago.com/216-222
	Item no.: 216-223 Ferrule; Sleeve for 1 mm ² / AWG 18; insulated; electro-tin plated	www.wago.com/216-223
	Item no.: 216-224 Ferrule; Sleeve for 1.5 mm ² / AWG 16; insulated; electro-tin plated	www.wago.com/216-224
	Item no.: 216-241 Ferrule; Sleeve for 0.5 mm ² / AWG 22; insulated; electro-tin plated; electrolytic copper; gastight crimped; acc. to DIN 46228, Part 4/09.90	www.wago.com/216-241
	Item no.: 216-242 Ferrule; Sleeve for 0.75 mm ² / AWG 20; insulated; electro-tin plated; electrolytic copper; gastight crimped; acc. to DIN 46228, Part 4/09.90	www.wago.com/216-242
	Item no.: 216-243 Ferrule; Sleeve for 1 mm ² / AWG 18; insulated; electro-tin plated; electrolytic copper; gastight crimped; acc. to DIN 46228, Part 4/09.90	www.wago.com/216-243
	Item no.: 216-244 Ferrule; Sleeve for 1.5 mm ² / AWG 16; insulated; electro-tin plated; electrolytic copper; gastight crimped; acc. to DIN 46228, Part 4/09.90	www.wago.com/216-244
	Item no.: 216-262 Ferrule; Sleeve for 0.75 mm ² / AWG 20; insulated; electro-tin plated; electrolytic copper; gastight crimped; acc. to DIN 46228, Part 4/09.90	www.wago.com/216-262
	Item no.: 216-263 Ferrule; Sleeve for 1 mm ² / AWG 18; insulated; electro-tin plated; electrolytic copper; gastight crimped; acc. to DIN 46228, Part 4/09.90	www.wago.com/216-263
	Item no.: 216-264 Ferrule; Sleeve for 1.5 mm ² / AWG 16; insulated; electro-tin plated; electrolytic copper; gastight crimped; acc. to DIN 46228, Part 4/09.90	www.wago.com/216-264
	Item no.: 216-284 Ferrule; Sleeve for 1.5 mm ² / AWG 16; insulated; electro-tin plated; electrolytic copper; gastight crimped; acc. to DIN 46228, Part 4/09.90	www.wago.com/216-284
	Item no.: 216-301 Ferrule; Sleeve for 0.25 mm ² / AWG 24; insulated; electro-tin plated	www.wago.com/216-301
	Item no.: 216-302 Ferrule; Sleeve for 0.34 mm ² / AWG 24; insulated; electro-tin plated	www.wago.com/216-302



Item no.: 216-321

Ferrule; Sleeve for 0.25 mm² / AWG 24; insulated; electro-tin plated

www.wago.com/216-321



Item no.: 216-322

Ferrule; Sleeve for 0.34 mm² / AWG 24; insulated; electro-tin plated

www.wago.com/216-322

Downloads

smartDATA

PCB libraries

TARGET Library for WAGO PCB Terminal Blocks Compatible with TARGET PCB Design Software Version 17.x	1.1.0 Oct 6, 2014	ZIP 27.1 MB	Download
EAGLE Library for WAGO PCB Terminal Blocks Compatible with EAGLE PCB Design Software Version 6.x or higher	2.1 Nov 17, 2017	ZIP 23.9 MB	Download
DesignSpark Library for WAGO PCB Terminal Blocks Compatible with DesignSpark PCB Version 4.x or higher	2.1 Oct 6, 2014	ZIP 22.5 MB	Download

CAD data

3D Download 236-524/000-009/999-950	URL	Download
-------------------------------------	-----	----------

Subject to changes.

WAGO Kontakttechnik GmbH & Co. KG
 Hansastr. 27
 32423 Minden
 Phone: +49571 887-0 | Fax: +49571 887-169
 Email: info.de@wago.com | Web: www.wago.com

Do you have any questions about our products?
 We are always happy to take your call at +49 (571) 887-44222.